

INSPIRED INNOVATION

**Despatch**  
INDUSTRIES

# PROTOCOL MANAGER NETWORK UTILITY SOFTWARE INSTRUCTION MANUAL

E-107  
PN 324870  
REVISION 1  
3/2013

## SERVICE AND TECHNICAL SUPPORT

**service parts:** 1-800-473-7373

**international service/main:** 1-952-469-8230

**service fax:** 1-952-469-8193

[service@despatch.com](mailto:service@despatch.com)

## GLOBAL HEADQUARTERS

**phone:** 1-888-DESPATCH (1-888-337-7282)

**international/main:** 1-952-469-5424

**fax:** 1-952-469-4513

[sales@despatch.com](mailto:sales@despatch.com)

[www.despatch.com](http://www.despatch.com)

8860 207th Street West  
Minneapolis, MN 55044 USA

**Despatch**  
INDUSTRIES

MINNEAPOLIS • SHANGHAI • BERLIN • SINGAPORE • TAIPEI

## Revision History

Revision	Date	Author	Description
B			Various corrections
C			Various corrections
D			Various corrections
E			Various corrections
F			Various corrections
G			Various corrections
H	8/2011	K. Meyer	Updated for Version 6.0
1	3/2013	K. Livingston	For use with Protocol Plus and Protocol 3 controllers

---

**Copyright © 2013 by Despatch Industries.**

All rights reserved. No part of the contents of this manual may be reproduced, copied or transmitted in any form or by any means including graphic, electronic, or mechanical methods or photocopying, recording, or information storage and retrieval systems without the written permission of Despatch Industries, unless for purchaser's personal use.

---

## Table of Contents

1.	About This Manual.....	6
1.1.	Important User Information.....	6
1.2.	Manufacturer & Service .....	7
1.3.	Organization of this Manual .....	7
1.4.	Conventions.....	8
1.5.	System Requirements .....	8
2.	Theory of Operation .....	9
2.1.	Protocol Manager Software.....	9
2.2.	The Protocol 3 Controller.....	9
2.3.	The Protocol Plus Controller .....	10
3.	Installation & Setup.....	12
3.1.	System Requirements .....	12
3.2.	Configure Controllers.....	12
3.2.1.	Configure the Protocol 3 Controller .....	12
3.2.2.	Configure the Protocol Plus Controller .....	13
3.3.	Install Protocol Manager Software .....	13
3.4.	Protocol Manager Software Setup.....	16
3.4.1.	Startup and Login .....	16
3.4.2.	Comm Setup Tab.....	17
3.4.3.	Network Tab Setup.....	19
3.4.4.	Windows Tab Setup .....	21
3.4.5.	Passwords Tab Setup.....	22
3.5.	Network Summary Window .....	24
3.6.	Controller Run Time Window .....	24
3.7.	Set Up Initial Recipe .....	26
3.7.1.	Set Up Initial Recipe: Protocol 3.....	26
3.7.1.1.	Configure Initial Recipe: Protocol 3.....	26
3.7.1.2.	Save Initial Recipe: Protocol 3 .....	28
3.7.1.3.	Write a Recipe to the Protocol 3 Controller .....	28
3.7.1.4.	Open An Existing Recipe: Protocol 3.....	28
3.7.1.5.	Read a Recipe from the Protocol 3 .....	28
3.7.2.	Set Up Initial Recipe: Protocol Plus .....	28
3.7.2.1.	Configure Initial Recipe (Protocol Plus) .....	29
3.7.2.2.	Save Initial Recipe: Protocol Plus Controller .....	33
3.7.2.3.	Write a Recipe to the Protocol Plus Controller .....	33
3.7.2.4.	Open An Existing Recipe: Protocol Plus Controller .....	33
3.7.2.5.	Read a Recipe from the Protocol Plus Controller.....	34
3.8.	Datalog Functions.....	34
3.8.1.	Configure Profile Datalog .....	34
3.8.2.	Configure Lot Datalog.....	37
4.	Starting the Controller .....	38
4.1.	Working with Recipes and Profiles .....	38
4.1.1.	Create a New Profile .....	38
4.1.2.	Open an Existing Saved Recipe.....	38
4.2.	Start a Controller .....	38
4.2.1.	Start Controller in the Run Time Window .....	40
4.2.1.1.	Starting with Manual Mode.....	40

---

4.2.1.2.	Starting with Timer Mode .....	41
4.2.1.3.	Starting with Profile Mode .....	41
5.	Troubleshooting.....	43
5.1.	Controller Firmware Revision .....	43
5.2.	Troubleshoot Controller Parameters.....	43
5.3.	Troubleshoot Protocol Manager Parameters .....	43
5.4.	Controller Hardware and Cabling.....	45
5.4.1.1.	Check Cabling Between Controller and Outside of Oven .....	45
5.4.1.2.	Check Cabling between Computer and Outside of Oven .....	46
6.	Appendices .....	51
6.1.	Protocol Plus Communication Card Installation And Jumper Settings.....	51
6.1.1.	Communication Card Installation.....	52
6.1.2.	Communication Card Jumper settings.....	53
6.1.3.	Protocol Plus Controller Wiring Diagrams .....	53
6.1.4.	Connecting Controllers to a Communications Host PC .....	55
6.1.4.1.	Overview of Networking Multiple Protocol Plus Controllers .....	55

**Figures**

Figure 1.	Protocol Manager Software. ....	9
Figure 2.	Protocol 3 Operator Interface.....	10
Figure 3.	Protocol Plus Controller Faceplate.....	11
Figure 4.	Protocol Plus Displays and Control Buttons.....	11
Figure 5.	Protocol Manager Installer Welcome Screen.....	13
Figure 6.	Accept License Agreement. ....	14
Figure 7.	Destination Folder Screen.....	14
Figure 8.	Install Screen.....	15
Figure 9.	Installation Completed Screen. ....	16
Figure 10.	Login Dialogue Box.....	17
Figure 11.	User ID color reflects access level.....	17
Figure 12.	Setup Pull Down Menu.....	17
Figure 13.	Software Setup Window. ....	18
Figure 14.	Comm Setup Tab. ....	18
Figure 15.	Setting Up Network of Controllers. ....	19
Figure 16.	Controller Setup Dialogue Windows (complete with reference to Table 1). ....	20
Figure 17.	Windows Tab.....	22
Figure 18.	Passwords tab dialogue box. ....	23
Figure 19.	Network Summary Screen. ....	24
Figure 20.	Controller Run Time Window. ....	25
Figure 21.	Configure a recipe.....	26
Figure 22.	Protocol 3 Recipe Editor.....	26
Figure 23.	Identify Protocol 3 Controller using pull-down menu. ....	28
Figure 24.	Protocol Plus Recipe Editor. ....	29
Figure 25.	Profile Datalog Tab.....	34
Figure 26.	Lot Datalog Screen.....	37
Figure 27.	Window Pull-Down Menu.....	38
Figure 28.	Network Summary Screen. ....	39
Figure 29.	Protocol Plus Controller Run Time Window.....	39
Figure 30.	Run Time Window showing manual tab.....	40

---

Figure 31. Run in Manual Mode. ....	40
Figure 32. Run in Timer Mode.....	41
Figure 33. Run in Profile Mode (typical screens). ....	42
Figure 34. Log in at highest security level. ....	43
Figure 35. Window Pull Down Menu. ....	44
Figure 36. Comm Setup Typical Settings.....	44
Figure 37. Check network controller parameters. ....	45
Figure 38. Run Time Window Online light indicates successful communication with controllers. .....	45
Figure 39. Check Cabling Between Controller and Oven. ....	46
Figure 40. Older model serial converter.....	47
Figure 41. Newer model serial converter. ....	48
Figure 42. USB Converter.....	49
Figure 43. Controller rear view with Communications Card (left). ....	52
Figure 44. Communication Card Jumper Settings.....	53
Figure 45. RS485 Wiring (2 wire).....	54
Figure 46. RS422A Wiring (4 wire).....	54
Figure 47. RS232 Wiring. ....	54
Figure 48. Junction Box Wiring.....	56

**Tables**

Table 1. Communication Page Parameters and Values. ....	13
Table 2. Controller Setup Fields.....	20
Table 3. Protocol Manager Levels of Access. ....	22
Table 4. Protocol 3 Controller Recipe Editor Fields and Descriptions. ....	27
Table 5. Protocol Plus Controller Recipe Editor Fields and Descriptions. ....	31
Table 6. Profile Datalog Tab. ....	35
Table 8. Networking Cable Terminal & Pin Numbers. ....	56

# 1. About This Manual

## 1.1. Important User Information



**Copyright © 2013 by Despatch Industries.**

All rights reserved. No part of the contents of this manual may be reproduced, copied, or transmitted in any form or by any means including graphic, electronic, or mechanical methods or photocopying, recording, or information storage and retrieval systems without the written permission of the publisher, unless it is for the purchaser's personal use.

Printed and bound in the United States of America.

The information in this manual is subject to change without notice and does not represent a commitment on the part of Despatch Industries. Despatch Industries does not assume any responsibility for any errors that may appear in this manual.

In no event will Despatch Industries be liable for technical or editorial omissions made herein, nor for direct, indirect, special, incidental, or consequential damages resulting from the use or defect of this manual.

	<p><b><i>Before operating this equipment, carefully read instruction manual.</i></b></p>
	<p><b><i>Values displayed on screens are examples only. Though those values may be typical, contact Despatch Industries for the final value.</i></b></p>
	<p><b><i>Users of this equipment must comply with operating procedures and training of operation personnel as required by the Occupational Safety and Health Act (OSHA) of 1970, Section 5 and relevant safety standards, as well as other safety rules and regulations of state and local governments. Refer to the relevant safety standards in OSHA and National Fire Protection Association (NFPA), section 86 of 1985.</i></b></p>

**Copyright © 2013 by Despatch Industries.**

All rights reserved. No part of the contents of this manual may be reproduced, copied or transmitted in any form or by any means including graphic, electronic, or mechanical methods or photocopying, recording, or information storage and retrieval systems without the written permission of Despatch Industries, unless for purchaser's personal use.

	<p><b><i>Danger!</i></b></p> <p><b><i>Only fully-trained and qualified personnel should setup and maintain this equipment. Improper setup and operation of this equipment could cause an explosion that may result in equipment damage, personal injury or possible death.</i></b></p>
---	--

The information in this document is not intended to cover all possible conditions and situations that might occur. The end user must exercise caution and common sense when installing or maintaining Despatch Industries products. If any questions or problems arise, call Despatch Industries at **1-888-DESPATCH** or **1-952-469-5424**.

## **1.2. Manufacturer & Service**

The Protocol Manager is manufactured by Despatch Industries.

Despatch has specialized in thermal processing for over 100 years. Technical expertise gained over those years helps provide innovative solutions to critical applications in vertical markets and cutting edge technology worldwide. Despatch products are backed by a drive for long-term customer satisfaction and a strong sense of responsibility. The worldwide network of factory-trained Service Professionals is available to support your Despatch equipment. From full service preventive maintenance to routine repair and certified calibration and uniformity, the Despatch service network is positioned to respond to your business needs. Our service programs are customized to meet your specific needs using our Advantage Service Assurance Program (ASAP). For more information on ASAP, visit **www.despatch.com**.



<b>Global Headquarters</b>	<b>Contact</b>	<b>Service &amp; Technical Support</b>
<b>Despatch Industries</b> 8860 207th Street Lakeville, MN 55044 USA	International/Main: 1-952-469-5424 US toll free: 1-888-337-7282 Fax: 1-952-469-4513 info@despatch.com www.despatch.com	Service: 1-952-469-8230 US toll free: 1-800-473-7373 Service@despatch.com

## **1.3. Organization of this Manual**

This owner's manual contains a the most comprehensive set of information for the Despatch Protocol Manager, including installation instructions, theory of operation, and operating instructions, among other things. To save time and expense in case of trouble, it is urged that the operators search this manual for helpful suggestions before requesting factory assistance.

	<p><b><i>Danger!</i></b></p> <p><i>Failure to heed warnings in this instruction manual and on the oven could result in personal injury, property damage or death.</i></p>
---	---

## 1.4. Conventions

	<p><i>This icon signifies information that describes an unsafe condition that may result in death, serious injury, or damage to the equipment.</i></p>
<p><b>Danger!</b></p>	<p><i>Danger is the signal word used to indicate a hazardous situation that, if not avoided, will result in death or severe injury.</i></p>
<p><b>Warning!</b></p>	<p><i>Warning is the signal word used to indicate a hazardous situation that, if not avoided, could result in death or severe injury.</i></p>
<p><b>Caution!</b></p>	<p><i>Caution is the signal word used to indicate a hazardous situation that, if not avoided, could result in moderate or minor injury.</i></p>
<p>Notice</p>	<p><i>Notice is the signal word used to indicate a hazardous situation that, if not avoided, could result in property damage.</i></p>
	<p><i>This icon signifies supplemental important information.</i></p>
<p><b>LOG OUT</b></p>	<p><i><b>Bold, 10 point sans-serif typeface indicates a specific key or button on screen to click.</b></i></p>

## 1.5. System Requirements

The host computer must meet these requirements:

- Computer running Windows XP, Vista or Windows 7 (32 or 64-bit version) operating system
- Despatch oven(s) equipped with Protocol Plus™ and/or Protocol 3™ firmware 2.3 or higher controllers and communications hardware



## 2. Theory of Operation

### 2.1. Protocol Manager Software

The Despatch Protocol Manager network utility software enables the operation of up to 32 Protocol 3 and/or Protocol Plus controllers from a single, remote PC.

Protocol Manager software allows:

- Remote access and operation of one or more Protocol 3 and Protocol Plus controllers
- Use of a centralized PC to store and edit profiles
- Download the same profile to multiple controllers
- Upload a profile from a particular controller to the central PC for use in other controllers
- Centralized data logging from all controllers connected to the central PC
- Password security



**Figure 1. Protocol Manager Software.**



***Use this Instruction Manual in conjunction with the Protocol 3 and Protocol Plus Controller Owner's Manual.***

### 2.2. The Protocol 3 Controller

The Protocol 3™ is a microprocessor based digital temperature controller designed for simple and flexible oven operation (Figure 2). The Protocol 3 controller operates as a dual-functioning controller/High Limit instrument. The control portion utilizes a time-proportioning voltage signal to control heating devices with minimal temperature fluctuations.

The Protocol 3 controller provides three primary operating modes:

- Manual: Oven operates continuously at a fixed temperature until turned off.
- Timer: Oven operates at a fixed temperature for a user-selected time period, and then automatically turns off.
- Profile: Temperatures increase or decrease as defined by 255 segments that can be allocated to 64 ramp and soak profiles. The profiles can be linked to provide additional temperature combinations.

Review the Protocol 3 Controller Owner's Manual for more information.

---

**Copyright © 2013 by Despatch Industries.**

All rights reserved. No part of the contents of this manual may be reproduced, copied or transmitted in any form or by any means including graphic, electronic, or mechanical methods or photocopying, recording, or information storage and retrieval systems without the written permission of Despatch Industries, unless for purchaser's personal use.

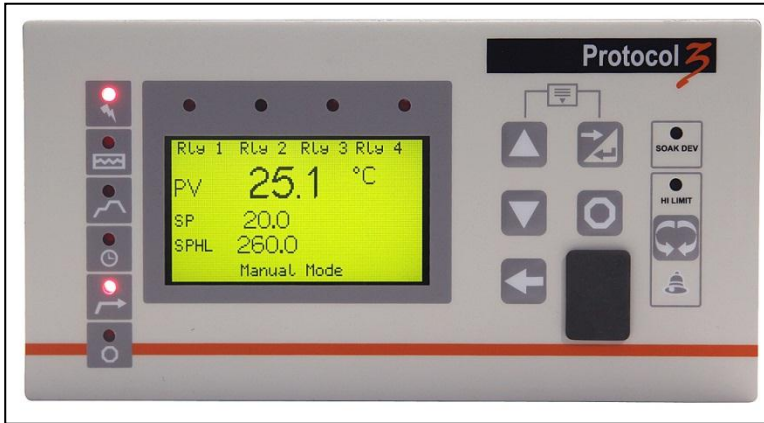
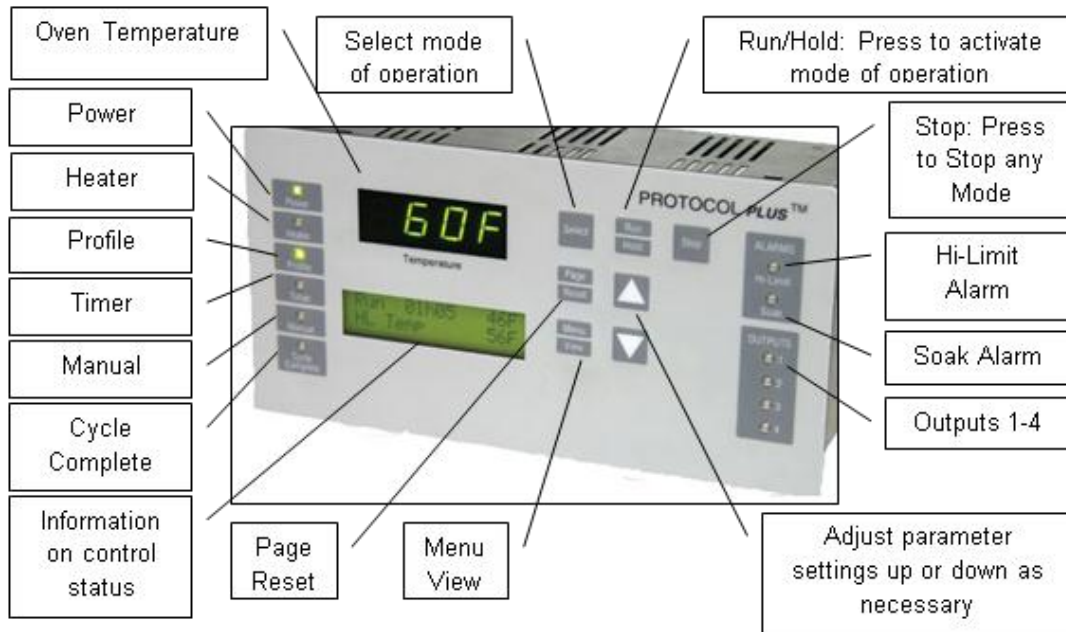

Figure 2. Protocol 3 Operator Interface.

### 2.3. The Protocol Plus Controller

The Protocol Plus controller provides outputs for the cooling fan, door lock switch/door release pushbutton, and optional beacon light. As many as eight profiles for oven heating cycles are stored in the Protocol Plus controller. Access profiles using the Protocol Plus keypad. The Protocol Plus controls the solenoid valves in an inert atmosphere oven for purge and to maintain operation. The Protocol Plus controller has an integrated high limit function which disables the heater output when tripped.

The Protocol Plus controller has two displays. A dedicated LED upper display shows the oven temperature (Figure 4). A two line LCD lower display provides information on control status, high limit temperature and allows changes to be made to the control settings. Figure 3 shows a schematic of the Protocol Plus face plate.



**Figure 4. Protocol Plus Displays and Control Buttons.**

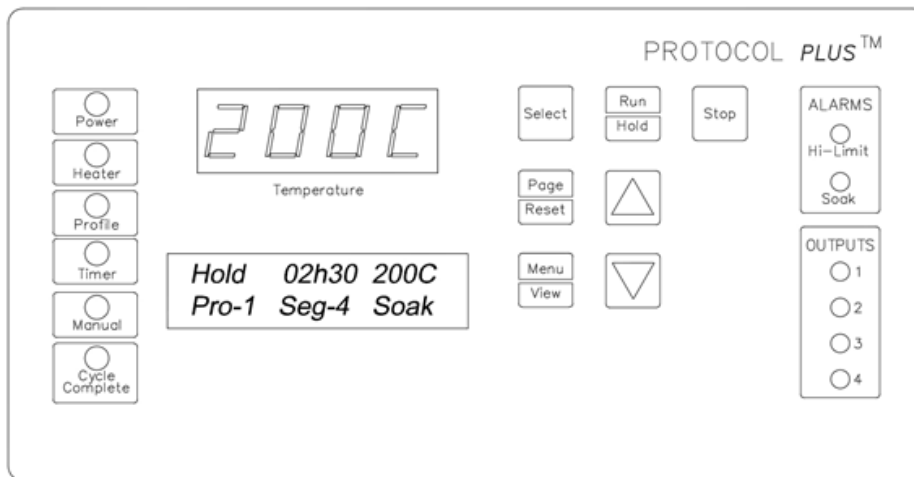

**Figure 3. Protocol Plus Controller Faceplate.**

### 3. Installation & Setup

Installation and Setup provides directions for installing and connecting the Protocol Manager software.

	<p><b><i>“Profile” and “Recipe” are used interchangeably throughout the Protocol 3, Protocol Plus, Protocol Manager to indicate those instructions assigned to carry out certain processes.</i></b></p>
---	---

#### 3.1. System Requirements

The control computer must meet these requirements:

- Computer running Windows XP, Vista or Windows 7 (32 or 64-bit version) operating system
- Despatch oven(s) equipped with Protocol Plus and/or Protocol 3 firmware 2.3 or higher controllers and communications hardware

The Installation and Setup procedures use the Protocol 3 and Protocol Plus Controller. Consult the Protocol 3 Controller Owner’s Manual (E-105) or the Protocol Plus Controller Owner’s Manual (E98) for more detail as needed.

	<p><b><i>Note that the Protocol 3 controller must be running firmware 2.3 or higher.</i></b></p>
---	--

#### 3.2. Configure Controllers

Before completing the Protocol Manager software setup, set up each controller.

- List the unique addresses that will be applied to each Protocol 3 or Protocol Plus controller, numbered from 1-255
- Locate each Protocol 3/Protocol Plus controller

##### 3.2.1. Configure the Protocol 3 Controller

Assign a unique address to each controller and set other communication parameters. See the Protocol 3 Controller Owner’s Manual (E-105, PN313327) for more information. Typical settings include:

1. Enter the **Main Menu**
2. Enter the **Configuration Menu**
3. Enter **Comms Configuration**
4. Set **Modbus Parity Bit** to **None**
5. Set **Modbus Data Rate** to **19200**
6. Set unique **Modbus Address**: from **1** to **255**

### 3.2.2. Configure the Protocol Plus Controller

Assign a unique address to each controller and set other communication parameters. Use these typical settings unless setting up a customer application:

1. Enter the **Setup** mode
2. Press **Page** until Communication displays
3. Press **Menu**

	<p><i>If the display does not change, the controller does not have the communication board installed.</i></p>
---	---

4. Change each parameter in Table 1 by pressing **Menu** until the desired parameter is displayed, and **▲** or **▼** to change the value.

**Table 1. Communication Page Parameters and Values.**

Menu Item	Display	Description	Range
Address	Communication CommAddr	Sets address node for control	1 to 247
Mode	Communication Comm Mode	Turns on/off communications	OFF, Modbus
Baud Rate	Communication Baud Rate	Sets interface speed	2400, 4800, 9600, 19.2K, 38.4K
Parity	Communication Parity	Sets parity for interface	None, Odd, Even

### 3.3. Install Protocol Manager Software

	<p><i>Close all open applications on the host PC before installing the Protocol Manager software.</i></p>
---	---

1. Insert the Protocol Manager software CD-ROM into the CD drive of the control computer.
2. Click **Start** 
3. Click **Run** or type **Run** in the dialogue box to get to the **Run** screen
4. Click **Browse**
  - a. Change **Look In** (box at top of window) to the drive letter for your CD drive

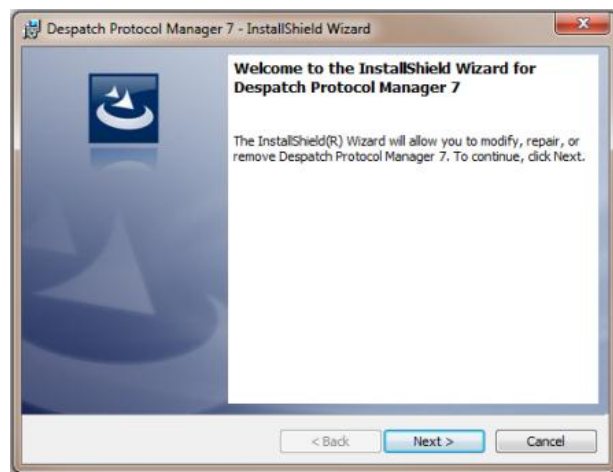
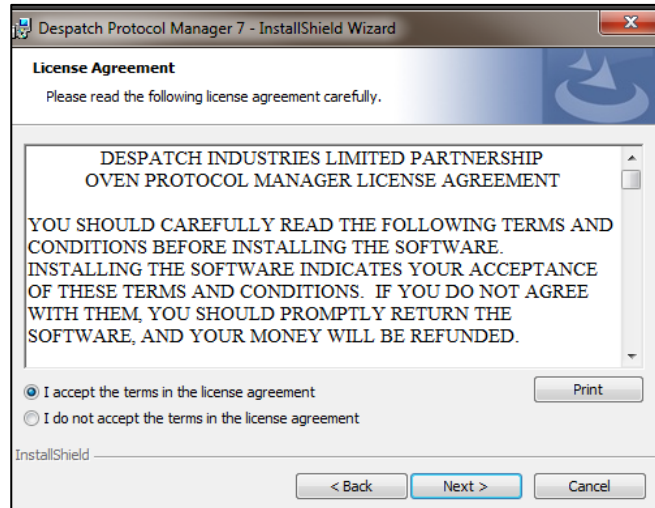

**Figure 5. Protocol Manager Installer Welcome Screen.**

**Copyright © 2013 by Despatch Industries.**

All rights reserved. No part of the contents of this manual may be reproduced, copied or transmitted in any form or by any means including graphic, electronic, or mechanical methods or photocopying, recording, or information storage and retrieval systems without the written permission of Despatch Industries, unless for purchaser's personal use.

- b. Locate **Despatch Protocol Manager**
- 5. Double-click **Despatch Protocol Manager** application to show the installer welcome screen (Figure 5)
- 6. Click **Next** to display the License Agreement (Figure 6).
- 7. Scroll down to read the agreement and accept the terms of the license agreement by clicking next to **I accept the terms in the license agreement.**
  - a. Print a copy for your records.
- 8. Click **Next** to continue



**Figure 6. Accept License Agreement.**

- 9. Follow directions for the Destination Folder screen, changing location as necessary by pressing **Change....** (Figure 7)
- 10. Click **Next** to continue to the final to the Install screen (Figure 8)

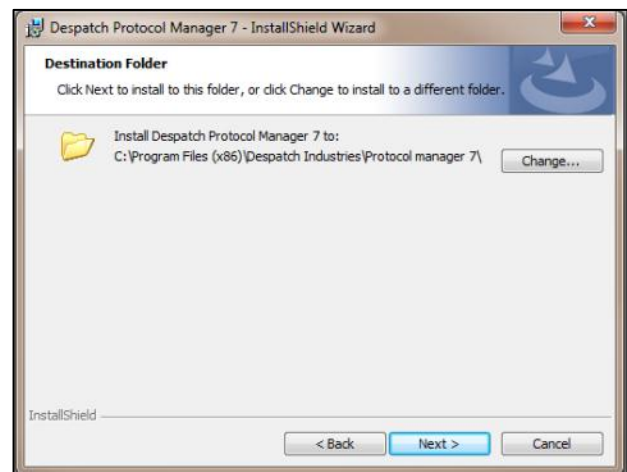

**Figure 7. Destination Folder Screen.**

11. If the Install screen is accurate, press **Install**.
  - a. Otherwise press **Back** to return to previous screens and correct information.

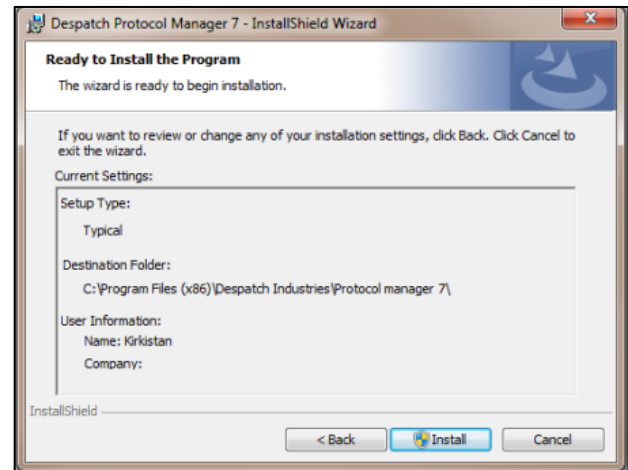

**Figure 8. Install Screen.**

After the installation has completed, click **Finish** on the InstallShield Wizard Completed screen (Figure 9).

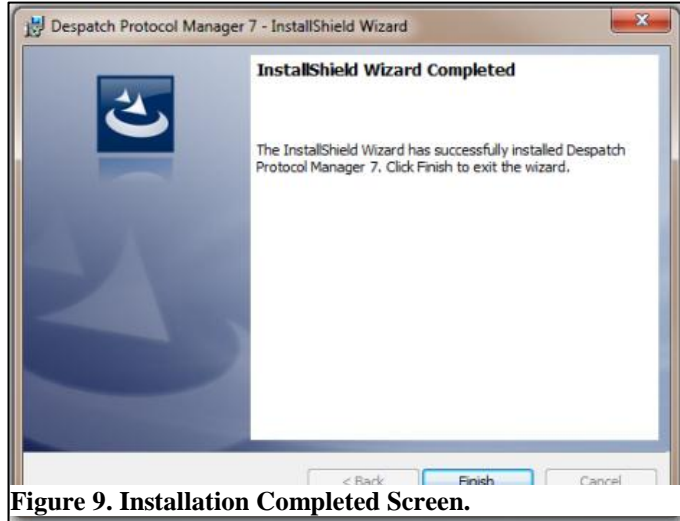

Figure 9. Installation Completed Screen.

### 3.4. Protocol Manager Software Setup

After installing the Protocol Manager software and configuring the controllers, setup the network.

#### 3.4.1. Startup and Login

This procedure uses the Protocol Manager Software installed on a PC.

1. Start Protocol Manager
  - a. Click **Start** 
  - b. Click **Programs**
  - c. Click **Protocol Manager** from the list of options

	<p><b><i>Logging in to Protocol Manager for the first time may signal a message that no setup information has yet been loaded and that a password is required. Enter the password “despatch” to proceed.</i></b></p>
---	--

2. Login to Protocol Manager
  - a. Click **Login** from the pull down menu (or double click on **logged out**)



	<b>Login requires an Operator ID and Password. The Operator ID is case-sensitive and up to 16 characters long. The default password is “despatch”</b>
---	---

- b. Complete the login dialogue box (Figure 10) with appropriate Operator ID and Password.
- c. After successful login, a User ID box will appear in the screen’s upper left corner (Figure 11). Color indicates the user’s level of access:
  - Blue = Level 2
  - Green = Level 3
  - Red = Level 4 (Administrative)

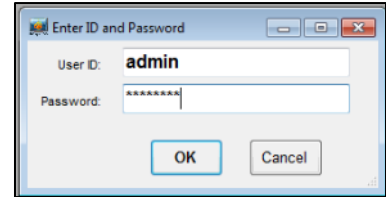

**Figure 10. Login Dialogue Box.**

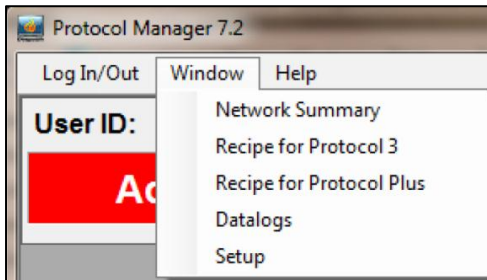

**Figure 11. User ID color reflects access level.**

### 3.4.2. Comm Setup Tab

Use the Comm Setup tab to prepare the Protocol Manager software to communicate with each Protocol 3/Protocol Plus controller.

- 1. Click **Window** (above the User ID) and then **Setup** (Figure 12) to display the Protocol Manager Setup (Figure 13).



**Figure 12. Setup Pull Down Menu.**

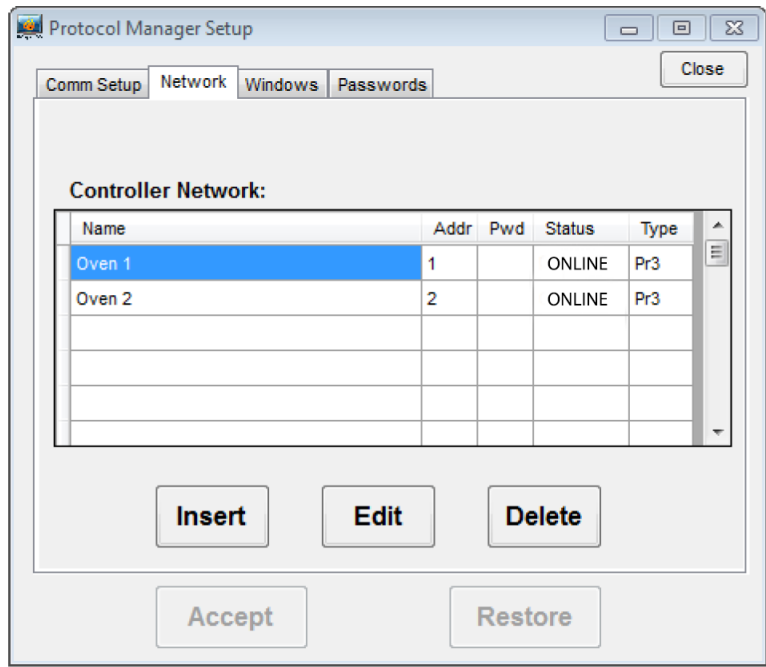

Figure 13. Software Setup Window.

2. Click **Comm Setup** and use the cursor to make the following selections—corresponding to the selections made on each Protocol 3/Protocol Plus controller (Figure 14).
  - a. Select appropriate port from **Port Selection** drop down menu (Figure 14). Select the communication port that matches your host computer hardware.
  - b. Select **Baud Rate**. Select the Baud Rate that corresponds to the rate programmed into the Protocol 3/Protocol Plus controller (s). 19.2K is the default configuration. 38.4 K provides the fastest communication.
  - c. Select **Parity Option**. Select the Parity Option that corresponds to the rate programmed into the Protocol 3/Protocol Plus controller (s). **None** is the default configuration.
  - d. **Use Long Timeout Delay** checkbox. The software uses a time to check protocol controller response time, which is critical when using multiple

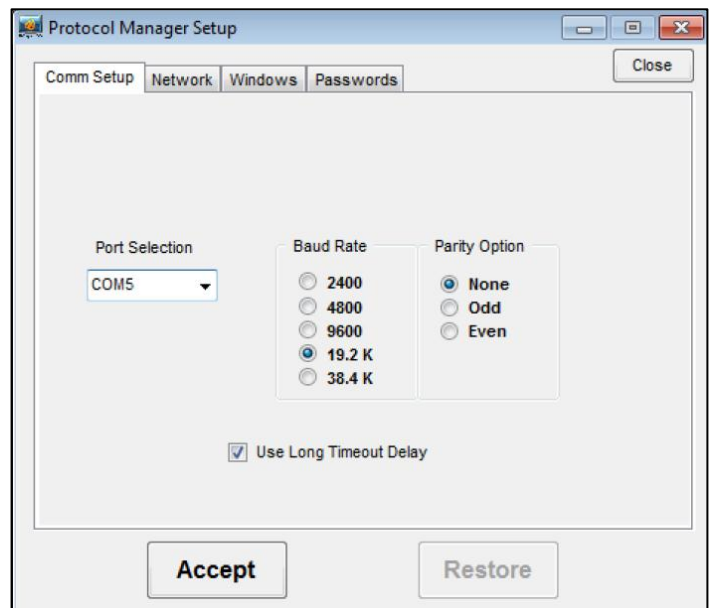



Figure 14. Comm Setup Tab.

- controllers. Default **Use Long Timeout Delay** is checked.
- e. Press **Accept** to save the parameters.

	<b><i>If the controller will not go online, try a lower Baud Rate.</i></b>
---	--

### 3.4.3. Network Tab Setup

Use the Network tab to prepare the Protocol Manager software to communicate with the network of controllers.

1. Click **Window** (above the User ID) and then **Setup** (Figure 12) to display the Protocol Manager Setup Window (Figure 15).
2. Click **Network** to begin adding controllers to the system (Figure 15).

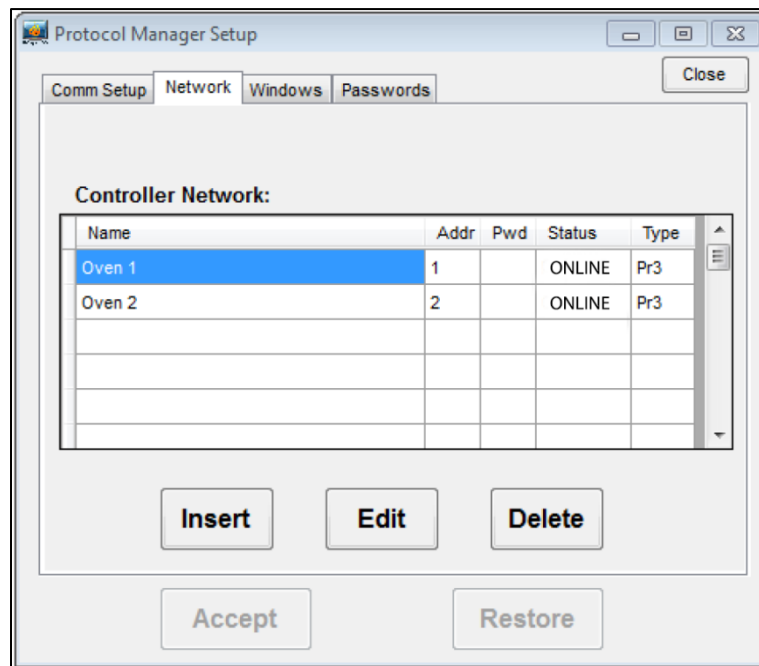



Figure 15. Setting Up Network of Controllers.

	<b><i>If the Insert / Edit / Delete buttons are not active (that is, grayed out), click the space below Name to activate.</i></b>
---	---

3. Add a Protocol 3/Protocol Plus that is controller connected to the host PC:

**Copyright © 2013 by Despatch Industries.**

All rights reserved. No part of the contents of this manual may be reproduced, copied or transmitted in any form or by any means including graphic, electronic, or mechanical methods or photocopying, recording, or information storage and retrieval systems without the written permission of Despatch Industries, unless for purchaser's personal use.

- a. Select the first blank line by clicking on it.
  - b. Press **Insert** to display the **Controller Setup** dialogue window (Figure 16).
4. Complete the information in the **Controller Setup** Dialogue Window using Table 2. Note that the Protocol Plus also requires a password (default value is 2). Click “Yes” for the additional dialogue window.

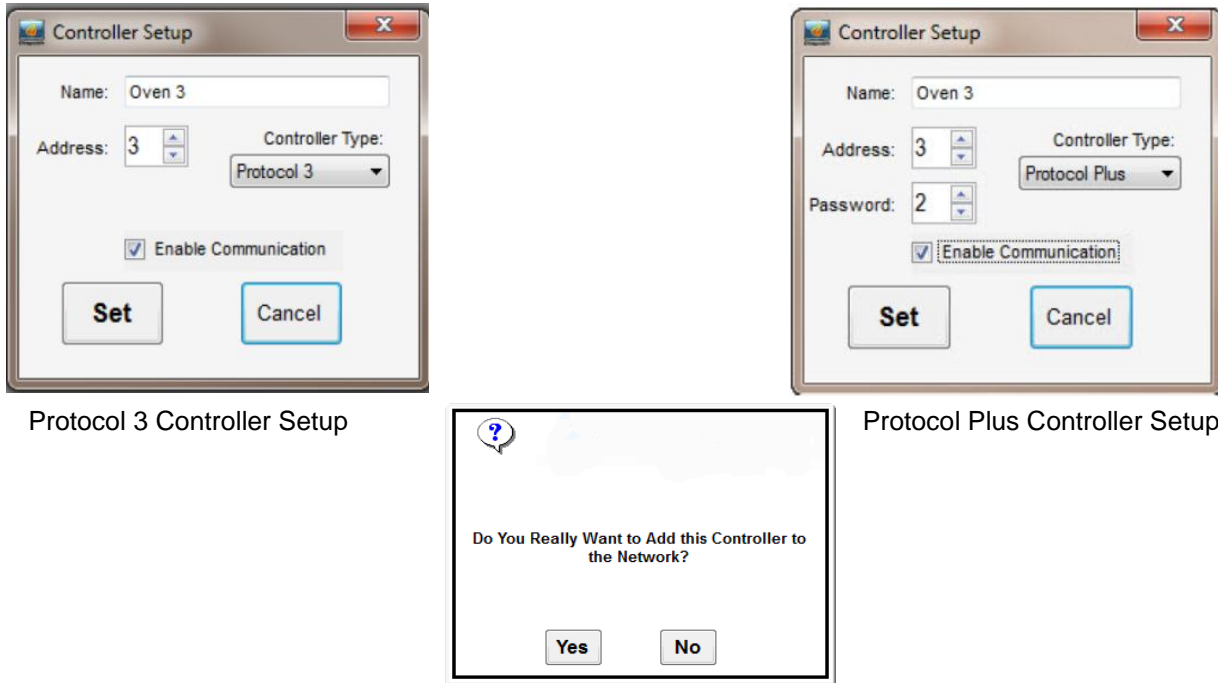

Figure 16. Controller Setup Dialogue Windows (complete with reference to Table 2).

Table 2. Controller Setup Fields.

Field	Purpose
<b>Name</b>	Unique name of oven or controller, maximum 24 characters
<b>Address</b>	Unique address of oven or controller. Enter address with keypad or use arrows. Address must correspond with the address programmed into the controller (Refer to Section 3.2). Values 1-256 are accepted.
<b>Controller Type</b>	Choose Protocol 3 or Protocol Plus depending on the controller type
<b>Password</b> (For Protocol Plus controllers only)	Enter the password that corresponds to the desired level of access (Refer to Section 3.4.5 for information on access levels). Default value is 2.
<b>Enable Communication</b>	Check the box to add the controller to the list of controllers controlled by the software.  Note: If the <b>Controller Network</b> ( <b>Network</b> tab—Figure 15) shows <b>Disabled</b> in the <b>Status</b> column, navigate to the Controller Setup Dialogue Window (Figure 16) and recheck <b>Enable Communication</b> .  If the controller is disabled (by unchecking <b>Enable</b>

Copyright © 2013 by Despatch Industries.

All rights reserved. No part of the contents of this manual may be reproduced, copied or transmitted in any form or by any means including graphic, electronic, or mechanical methods or photocopying, recording, or information storage and retrieval systems without the written permission of Despatch Industries, unless for purchaser's personal use.

---

	<b>Communication</b> ), communication between the Protocol Manager and an individual controller will not be attempted. Disabling a controller may be desirable if an oven is shut off or not used for a long period of time.
<b>Set/Cancel</b>	After entering the desired parameters, click <b>Set</b> save the parameters. Click <b>Cancel</b> to delete changes.  Click <b>Yes</b> in the dialogue window to add the controller to the network (Figure 16).

### 3.4.4. Windows Tab Setup

Use the Windows tab to select the parameters to display from the Protocol Manager **Network Summary Window/Controller Run Window**.

1. Click **Window** (above the User ID) and then **Setup** (Figure 12) to display the Software Setup Window. Press **Windows** to display the **Network Summary Window /Controller Run Time Window** (Figure 17).
2. Select desired display parameters
  - a. Click the box of each desired parameter to display.
  - b. Note that Network Summary Window is the left-most column of boxes.
3. Select the desired alarms sounds for High Limit trip and Soak Deviation (from guaranteed soak band)
  - a. Click the circle to choose the desire sound
  - b. If Protocol Manager detects no sound card, the Alarm Sounds field is grayed out.
  - c. Test the chosen sound parameter by clicking on **TEST**.
4. Press **Accept** to save the selected parameters or **Restore** to return to the previously saved parameters.



Figure 17. Windows Tab.

**Protocol Plus Controller Only:**

When the controller is running in Timer or Profile mode, click **Run/Hold** to put the process in Hold. Disable this function so it remains a Run only button by checking the box next to **DISABLE Process HOLD Function**.

**3.4.5. Passwords Tab Setup**

Use the Passwords tab to select software login levels for the Protocol Manager Software. Protocol Manager provides four levels of access for operators using the ovens (Table 3).

Table 3. Protocol Manager Levels of Access.

Access Level / Password	Access Allowed
Level 4	Highest level of access. Level 4 operators can change communication settings, add/delete controllers from the network, change passwords and perform all lower-level operations.
Level 3	Level 3 operators can edit/write recipes, configure data log settings and perform all lower-level operations.
Level 2	Level 2 operators can change controller modes, select profiles, change set points, start data logging and perform Level 1 operations.
Level 1	Lowest level of access. Level 1 operators view run-time status, and start, stop or hold controller operation. No password is required.

**Copyright © 2013 by Despatch Industries.**

All rights reserved. No part of the contents of this manual may be reproduced, copied or transmitted in any form or by any means including graphic, electronic, or mechanical methods or photocopying, recording, or information storage and retrieval systems without the written permission of Despatch Industries, unless for purchaser's personal use.

1. Click **Window** (above the User ID) and then **Setup** (Figure 12) to display the Software Setup Window. Press **Windows** to display the **Passwords** Tab Dialogue Box (Figure 18).

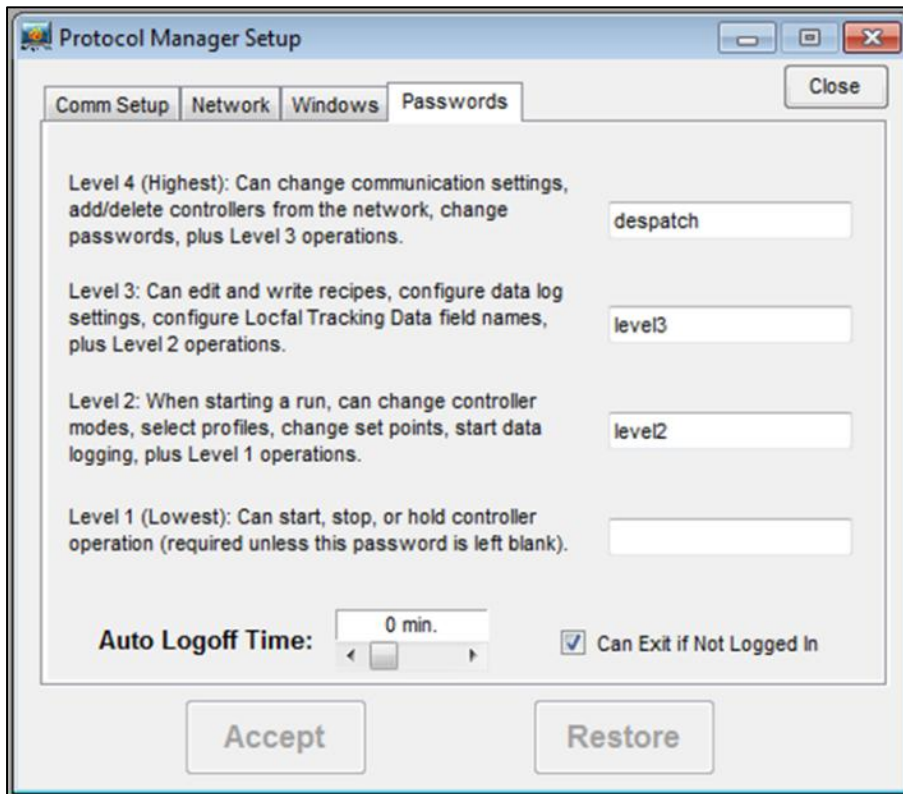

Figure 18. Passwords tab dialogue box.

2. Set **Auto Logoff Time**: time period before the operator is logged off
  - a. Set a value from 0 minutes to 60 minutes by sliding the bar.
  - b. Setting **Auto Logoff Time** to zero disables this feature and the system will not automatically log off.
  - c. Press **Accept** to save the selected parameters. Press **Restore** to return to the previously saved parameters.
3. **Can Exit if Not Logged In**:
  - a. Click/check to allow Protocol Manager to be stopped at any time.
  - b. If left unchecked, Protocol Manager can be stopped only if a user has successfully logged in at any level.
4. Exit **Setup Mode** by clicking **Close** or the **X** in the upper right corner of the **Protocol Manager Setup** window.

### 3.5. Network Summary Window

Click **Window** and then **Network Summary** to display the Network Summary Window (Figure 19).

The screenshot shows a window titled "NetSummary" with a "Close" button. Below the title bar is a table with the following data:

Name	Address	Online?	Mode	State	Setpoint	Temperature	Alarms	Events	Cycle	Buzzer
oven 1	1	Online	Manual	RUNNING	141°F	72 °F	(none)	1:Off2:Off	run	off
oven 2	2	Online	Manual	RUNNING	75°C	28 °C	3:ON	1:Off2:Off	run	off

Figure 19. Network Summary Screen.

Network Summary Window simultaneously displays parameters for all controllers connected in the system. Network Summary Window parameters include:

- Controller Name and Address
- Controller Online/Offline Status
- Operating Mode
- Run/Stop/Hold Status
- Temperature Setpoint and Value
- Alarms and Events Status
- Cycle Complete and Buzzer Status

Set the **NetSummary** parameters by selecting among the check boxes in the **Windows Tab** (Section 3.4.4, Figure 17). Double-click on a Controller ID in the **Name** column to display the associated **Controller Run Time** window (Figure 20).

### 3.6. Controller Run Time Window

The Controller Run Time Window displays the current status of an individual controller. Use this window to remotely control the controller operating mode and state.

Double-click on a Controller ID in the **NetSummary** screen **Name** column (Figure 19) to display the associated Controller Run Time Window (Figure 20). Controller Run Time Window parameters include:

- Controller Name and Address
- Temperature Setpoint and Value
- Alarms and Events Status
- Cycle Complete and Buzzer Status
- Operating Mode
- Run/Stop/Hold Status
- Controller Online/Offline Status
- High Limit Setpoint and Value
- Time Remaining in Timer Mode
- Profile, Segment, and Time in Profile Mode



- Operator ID
- Lot Information

Set the Controller Run Time Window parameters by selecting among the check boxes in the **Windows** Tab (Section 3.4.4). Note that if the Lot Datalogs box has not been enabled, the Controller Run Time Window as in Section 3.8 Datalog Functions.

Figure 20. Controller Run Time Window.

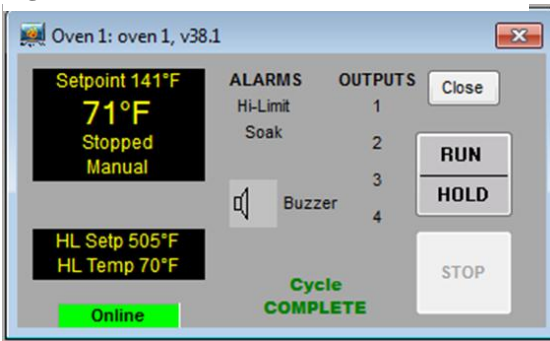

Controller Run Time Window: Collapsed View

Toggle between full and collapsed views by double-clicking in the top half of the window (above **Lot Datalogs**)



Controller Run Time Window: Expanded View

Recipes (profiles) can be started, run and stopped from this window. This window may be used to remotely control the controller's operating mode and state. If this window disappears, click on the **Network Summary** window and double-click in the controller name.

### 3.7. Set Up Initial Recipe

Recipes establish time and temperature instructions for each controller. Setting up Protocol Manager involves configuring recipes and then selecting the proper recipe for each use. Creating recipes with the Protocol 3 controller follows a different process than creating recipes with the Protocol Plus controller.

#### 3.7.1. Set Up Initial Recipe: Protocol 3

##### 3.7.1.1. Configure Initial Recipe: Protocol 3

Create a recipe by clicking on **Window** and selecting **Recipe/Datalog for Pr3** (Figure 21). The Recipe Editor Screen will appear (Figure 22).

Double click any field on the **Recipe Editor** screen to access an editing window. Move the slider or click in the white space or on the arrows to set the appropriate value. Click **OK** to save the value (**Cancel** to delete). See Table 4 for the complete list of fields, descriptions and parameters. See the Protocol 3 Programmer's manual for a sample profile.

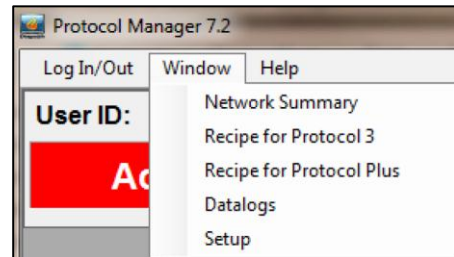

Figure 21. Configure a recipe.

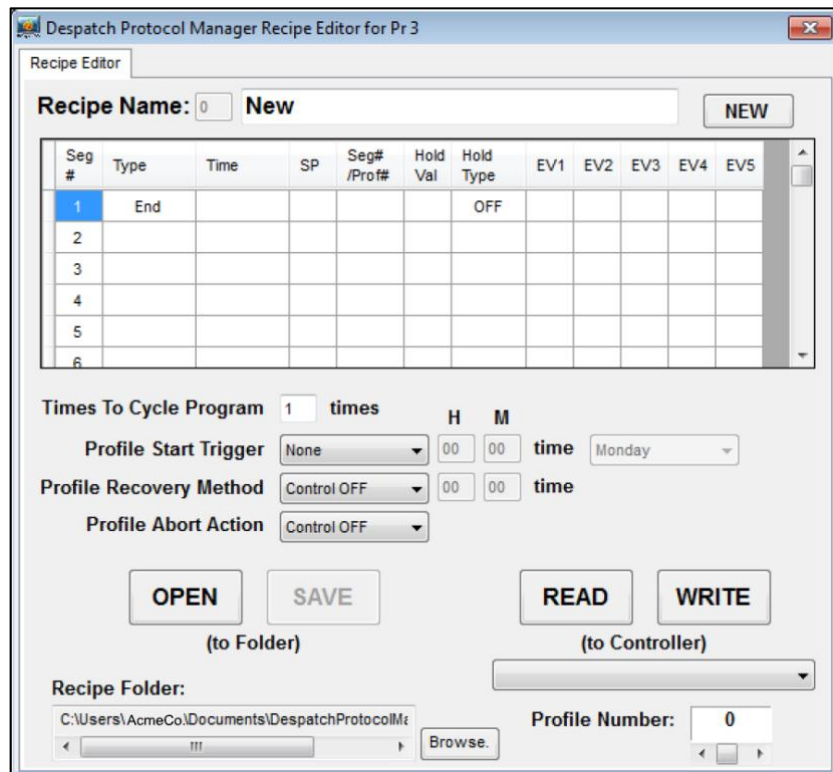

Figure 22. Protocol 3 Recipe Editor.

**Table 4. Protocol 3 Controller Recipe Editor Fields and Descriptions.**

Field	Description	Parameters
Recipe Name	Name of new recipe being created	Defaults to "NEW." Replace with desired name.
Seg #	Shows the number of the profile segment being created	From 1-255
Type	Set the segment type.	<ul style="list-style-type: none"> <li>• Ramp Time: time to reach target SP</li> <li>• Ramp Rate: rate of change towards target SP</li> <li>• Step: jump to target SP</li> <li>• Dwell: keep current SP</li> <li>• Hold: hold the profile until released</li> <li>• Loop: back to previous segment</li> <li>• Join: join to another profile)</li> <li>• End :end the profile</li> <li>• Repeat Sequence Then End: repeat a sequence of joined profiles—of which this is the last</li> <li>• A Join, End or Repeat</li> <li>• Sequence Then End will become the last segment in the profile</li> </ul>
Time	Desired Time	HH:MM:SS
Seg/Pr #	<p><b>Seg:</b> Segment number used with the Loop command</p> <p><b>Pr#:</b> Profile number used with the Join command</p>	Use "Seg" to identify the segment to return to when using the Loop command.
EV1	Events turn on for the duration of the segment.	For End Segments, the event state persists until another profile starts, the user exits from profiler mode, or the unit is powered down.
EV2		
EV3		
EV4		
EV5		
Times To Cycle Program	Enter the number of times to run the complete program	From 10
Profile Start Trigger	Instruction to begin the selected profile.	<ul style="list-style-type: none"> <li>• From: None (profile start is not delayed);</li> <li>• After Delay or Day and Time</li> </ul>
Profile Recovery Method	The power-on action if profile was running at power-down (for example, after a power cut), or following correction of a signal break.	From: Control outputs off; Restart profile; Maintain last profile setpoint; Use controller setpoint; Continue profile from where it was when power failed.
Profile Abort Action	Action after profile is forced to stop before its end.	From: Control outputs off; Maintain last profile setpoint or Use controller setpoint.
OPEN	Opens a recipe saved to the host PC	

SAVE	Saves a recipe to the host PC	
READ	Reads (uploads) a recipe from the desired controller.	
WRITE	Writes (downloads) a recipe to the desired controller	

### 3.7.1.2. Save Initial Recipe: Protocol 3

After keying in the desired recipe using **Recipe Editor**, press **SAVE** and identify the desired **Recipe Folder** (Figure 22). Note that recipes are saved only to the **Recipe Folder** location, not to the Protocol 3 controller itself.

### 3.7.1.3. Write a Recipe to the Protocol 3 Controller

After keying in the desired recipe using **Recipe Editor**, press **WRITE** to load the recipe to the desired controller (identified in pull down menu, Figure 23).

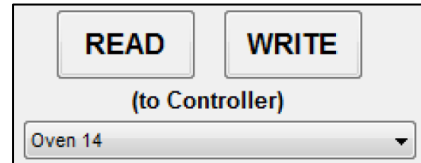

Figure 23. Identify Protocol 3 Controller using pull-down menu.

### 3.7.1.4. Open An Existing Recipe: Protocol 3

After a recipe has been saved to the **Recipe Folder** of the PC, it is available to open. Open a recipe by pressing **OPEN**, highlighting the desired recipe and pressing **OPEN** in the **Recipe Folder** (Figure 22).

### 3.7.1.5. Read a Recipe from the Protocol 3

Protocol Manager can read recipes residing on the Protocol 3 controller. Press **READ** from the **Recipe Editor** to load all the existing recipes from the desired Protocol 3 controller (identified in pull down menu, Figure 23).

## 3.7.2. Set Up Initial Recipe: Protocol Plus

Recipes establish time and temperature instructions for each controller. Setting up Protocol Manager involves configuring recipes and then selecting the proper recipe for each use. Creating recipes with the Protocol 3 controller follows a different process than creating recipes with the Protocol Plus controller.

### 3.7.2.1. Configure Initial Recipe (Protocol Plus)

Create a recipe by clicking on **Window** and selecting **Recipe/Datalog for Protocol Plus** (Figure 21). The Recipe Editor Screen will appear (Figure 24).

Double click any field on the Recipe Editor screen to access an editing window. Move the slider or click in the white space or on the arrows to set the appropriate value. Click **OK** to save the value (**Cancel** to delete). See Table 5 for the complete list of fields, descriptions and parameters

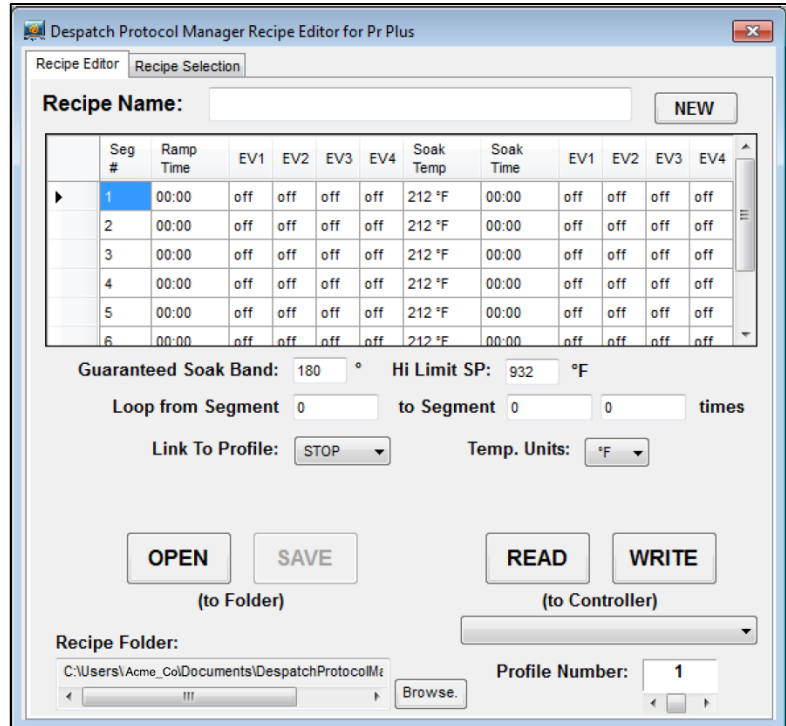





Figure 24. Protocol Plus Recipe Editor.

	<p><b>MODBUS Comm Error Message</b></p> <p><i>If a recipe Ramp Time, Soak Temp or Hi Limit SP value entered using the Recipe Editor is incompatible with the internally-set range for the target controller, the following error message displays:</i></p> <div data-bbox="664 554 1252 993" style="border: 1px solid black; padding: 10px; text-align: center;"><b>Despatch</b>  MODBUS Comm Error from Oven 1 Invalid Data Value  Increase Hi Limit SP or check Recipe for Ramp Times = 0  <input type="button" value="OK"/></div> <p><i>If the message appears, no changes will be made to the Controller profile.</i></p>
---	--

	<p><b>Incompatible Link to Profile Option Message</b></p> <p><b>The Link to Profile value STBY (Standby mode) can only be used with Protocol Plus controller version 4 or higher. If a recipe with Standby mode selected is chosen for download to an earlier-version controller, Protocol Manager displays this message:</b></p> <div style="border: 1px solid black; padding: 10px; text-align: center;">  <p>Incompatible 'Link To Profile' option:</p> <p>Target Controller's version does not support the Standby option. Recipe will be downloaded with the Hold option selected.</p> <p>OK</p> </div> <p><b>The downloaded profile Link to Profile is set to HOLD for that controller.</b></p>
---	---

**Table 5. Protocol Plus Controller Recipe Editor Fields and Descriptions.**

Field	Description	Parameters
Recipe Name	Name of new recipe being created	Defaults to "NEW." Replace with desired name.
Seg #	Number of profile segment being created	From 1 to 8 segments are available.
Ramp Time	Time required to ramp setpoint to temperature	<ul style="list-style-type: none"> <li>Enter values between 0 and 99:59</li> <li>Units are set locally at each controller as either hours and minutes (HH:MM) or minutes and seconds (MM:SS).</li> </ul>
EV1	Events 1-4 <sup>1</sup> programmed into the Ramp Time portion turn on for the duration of the segment.	
EV2		
EV3		
EV4		
Soak Temp <sup>2</sup>	Temperature for segment	<ul style="list-style-type: none"> <li>Enter values between -18 to</li> </ul>

<sup>1</sup> Note that these relays will actuate only when the controller has the relay cards installed and programmed for an event.

Field	Description	Parameters
		540°C (0 to 1000°F) <sup>2</sup> <ul style="list-style-type: none"> <li>• Unites are set locally at each controller as either hours and minutes (HH:MM) or minutes and seconds (MM:SS).</li> </ul>
Soak Time	Time required to ramp setpoint to temperature	<ul style="list-style-type: none"> <li>• Enter values between 0 and 99:59</li> <li>• Units are set locally at each controller as either hours and minutes (HH:MM) or minutes and seconds (MM:SS).</li> </ul>
Guaranteed Soak Band	If the process temperature deviates from the setpoint by more than this value, the timer is placed in a hold condition. The timer continues when the process temperature falls within range.	
Hi Limit SP	If the temperature exceeds this value, the hi-limit will alarm and shut off the heater. <sup>2</sup>	
Loop from Segment XX	Enter the desired segment number to jump from and the desired segment number to jump to along with the number of times that jump should be made.	
To Segment XX		
XX times		
Link to Profile <sup>3</sup>	Link to another profile at the end of a profile.	Possible values include: <ul style="list-style-type: none"> <li>• STOP: Stop oven operation</li> <li>• HOLD: Hold setpoint</li> <li>• 1 – 8: Jump to selected profile number</li> <li>• STBY: Enter standby mode<sup>3</sup></li> </ul>
Temp. Units	Select degrees Fahrenheit or Centigrade for the recipe display only.	Recipes stored on the host PC, like profiles in the Protocol Plus, are always stored with temperatures in degrees Fahrenheit, regardless of the

<sup>2</sup> In the recipe editor screen, **Soak Temp** and **Hi Limit SP** values can be adjusted in the range of -18 to 538°C (0-1000°F). Errors may occur attempting to download a recipe to a Protocol Plus controller profile if a recipe ramp time, soak temperature or high limit setpoint value is incompatible with the range set internally for the target controller. If a ramp time, soak temperature or high limit setpoint value is incompatible with the target controller’s range setting, an error message similar to Figure 23 will be displayed, and no changes will be made to the Controller's profile.

<sup>3</sup> The **Link to Profile** value **STBY** (Standby mode) can only be used with Protocol Plus controller version 4 or higher. If a recipe with the Standby mode selected is chosen for download to an earlier-version controller, the Protocol Manager displays a popup message and the downloaded profile will set **Link to Profile** to **HOLD** for that controller.



Field	Description	Parameters
		selected viewing units. Note that changing the display units converts displayed recipe temperatures accordingly.
OPEN	Opens a recipe saved to the host PC	
SAVE	Saves a recipe to the host PC	
READ	Reads (uploads) a recipe from the desired controller.	
WRITE	Writes (downloads) a recipe to the desired controller	
Profile Number	Select which of the Controller's eight profiles to use when reading or writing recipes.	
Recipe Selection Tab		
Field	Description	Parameters
Selectable Recipe Files	Press <b>Add</b> to open the window to saved recipes. Highlight the desired recipe.	
Recipe Selection Folder	Press Browse to navigate to the folder containing the desired recipes.	
Start Profile by Number	Click to identify recipes by profile number.	
Start Profile by Recipe Name	Click to identify recipes by name.	
Add	Press <b>Add</b> to open the window to saved recipes. Highlight the desired recipe.	
Delete	Press <b>Delete</b> to delete selected recipe.	

### 3.7.2.2. Save Initial Recipe: Protocol Plus Controller

After keying in the desired recipe using **Recipe Editor**, press **SAVE** and identify the desired **Recipe Folder** (Figure 24). Note that recipes are saved only to the **Recipe Folder** location, not to the Protocol Plus controller itself.

### 3.7.2.3. Write a Recipe to the Protocol Plus Controller

After keying in the desired recipe using **Recipe Editor**, press **WRITE** to load the recipe to the desired controller (identified in pull down menu, Figure 23).

### 3.7.2.4. Open An Existing Recipe: Protocol Plus Controller

After a recipe has been saved to the **Recipe Folder** of the PC, it is available to open. Open a recipe by pressing **OPEN**, highlighting the desired recipe and pressing **OPEN** in the **Recipe Folder** (Figure 20).

### 3.7.2.5. Read a Recipe from the Protocol Plus Controller

Protocol Manager can read recipes residing on the Protocol 3 controller. Press **READ** from the **Recipe Editor** to load all the existing recipes from the desired Protocol Plus controller (identified in pull down menu, Figure 24).

## 3.8. Datalog Functions

Datalog files periodically record controller data to a disk file for future analysis. Protocol Manager can maintain two different types of datalog files from networked controllers: Profile Datalogs and Log Datalogs:

- **Profile Datalogs:** Use Profile Datalogs for jobs based on a specific process run. Profile Datalogs are initiated automatically when a controller is remotely started running. Profile Datalogs are closed automatically when the controller stops running.
- **Log Datalogs:** Use Log Datalogs for jobs not related strictly to an entire, single process run. Log Datalogs are initiated (and subsequently closed manually) using the Controller Run Time Window, regardless of the controller's running status.

Both Profile Datalogs and Log Datalogs contain header information followed by periodic data records. Set header information and record data for both types of datalogs using the **Profile Datalog** tab. Both types of files will be stored in the Log File Folder path indicated in the **Profile Datalog** tab.

### 3.8.1. Configure Profile Datalog

The **Profile Datalog** tab (Figure 25) provides options for setting file naming options and log entry interval options. Table 6 lists available options for the Profile Datalog tab.

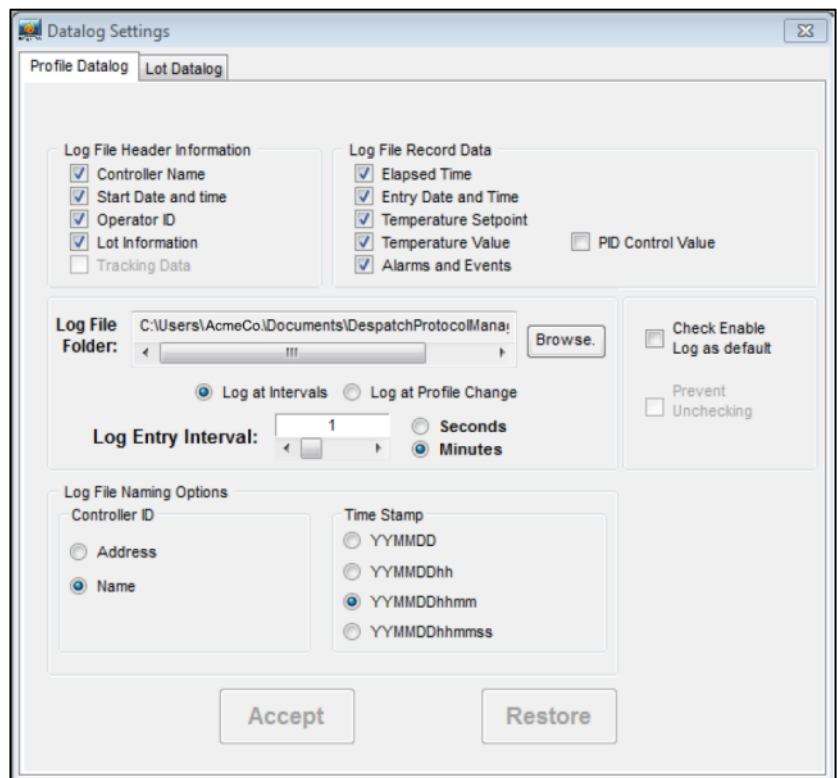

Figure 25. Profile Datalog Tab.

**Table 6. Profile Datalog Tab.**

Field	Description	Parameters
<b>Log File Header Information</b>		
Controller Name	Controller Name	Check box to select the desired header data to include in the log file
Start Date and Time	Start Date and Time	
Operator ID	Unique operator ID	
Lot Information	Lot information supplied by operator	
Tracking Data		
<b>Log File Record Data</b>		
Elapsed Time	Time since beginning of process run	Check box to select the desired types of data to include in the log file
Entry Date and Time	Entry Date and Time	
Temperature Setpoint	Temperature Setpoint	
Temperature Value	Temperature Value	
Alarms and Events	Alarms and Events	
PID Control Value	PID Control Value	
<b>Log File Folder</b>		
Log at Intervals/ Log at Profile Change	For Log at Intervals: Choose desired time to log data	Select whether logging will occur at set time intervals or at every change point programmed into the recipe, for instance, Start point, beginning of ramp, and the like. Typically a short run with few steps might use the time intervals option while a long run with many steps might use the profile change option.
Log Entry Interval	Slide to select desired longer inter intervals	In seconds or minutes
Log File Folder	Click Browse to navigate to desired folder.	
<b>Log File Naming Options</b>		
Controller ID	Choose address or name as controller ID	Controller ID identifies the controller by address (three digits with leading zeroes) or name. If name is selected, blank spaces and characters not legal for use in a Windows file name are converted to underscore characters.
Time Stamp	Choose desired format for the time stamp	

### Log File Naming Options

The Controller ID and Time Stamp are combined, but separated by an underscore character, to create a datalog file name prefix. The file name is automatically appended with a ".log" extension.

For a controller named "East Fab #1" with an address of 2, a datalog file name would either begin with "002" (if Address selected) or "East\_Fab\_#1" (if Name selected).

For a run started on February 4th, 2000, at 2:13:45 pm, the Time Stamp would be either "000204" (if YYMMDD selected), "00020414" (if YYMMDDhh selected), "0002041413" (if YYMMDDhhmm selected), or "000204141345" (if YYMMDDhhmmss selected).

If "Name" and "YYMMDDhh" were selected, the complete file name prefix would be "East\_Fab\_#1\_00020414", and the new datalog filename would be "East\_Fab\_#1\_00020414.log". If a file with that name already existed, however, the new file would be renamed "East\_Fab\_#1\_00020414\_1.log".

When a datalog is started, and a filename is created, duplicate filenames are checked for; if a file with the created name already exists, the new filename's prefix has an underscore and a numerical value appended to it to create a unique filename.

### 3.8.2. *Configure Lot Datalog*

Check **Enable Lot Datalogs** to allow datalog functions to be selected on a per-job basis rather than for all jobs (Figure 26). Choose the desired **Log Entry Interval** value and whether that value is in **Seconds** or **Minutes**. Press **Accept** to save changed values or **Restore** to return to previously saved values.

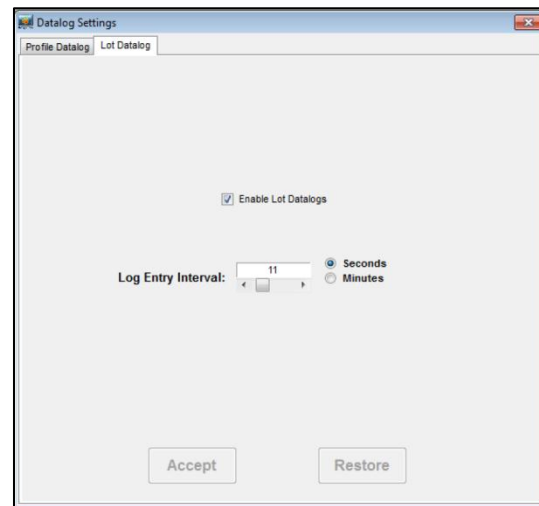

**Figure 26. Lot Datalog Screen.**

## 4. Starting the Controller

### 4.1. Working with Recipes and Profiles

	<p><i>“Profile” and “Recipe” are used interchangeably throughout the Protocol 3, Protocol Plus, Protocol Manager to indicate those instructions assigned to carry out certain processes.</i></p>
---	--

#### 4.1.1. Create a New Profile

For help creating recipes consult Section 3.7.

#### 4.1.2. Open an Existing Saved Recipe

1. Press **OPEN** on the Recipe Editor screen.
2. Select the recipe from the list of saved recipes and press **OPEN** to populate the recipe.
3. Write the recipe to the controller (Refer to Section **Error! Reference source not found.**).

## 4.2. Start a Controller

Prepare to start by reading the recipe from the controller (See Sections 3.7.1.5 or 3.7.2.5) or writing the desired recipe to the controller (See Sections 3.7.1.3 or 3.7.2.3).

Start a Protocol 3 or Protocol Plus controller by pulling down **Window** (Figure 27) and selecting **Network Summary** (Figure 28).

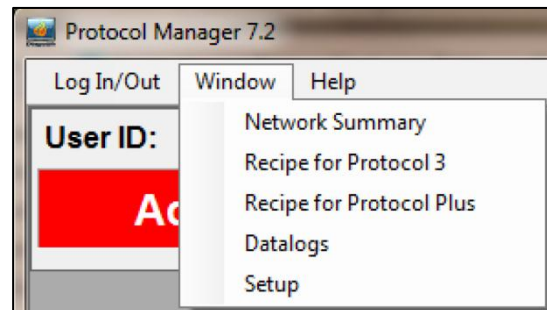

Figure 27. Window Pull-Down Menu.

Name	Address	Online?	Mode	State	Setpoint	Temperature	Alarms	Events	Cycle	Buzzer
Oven 14	5	Online	Select Mode	Stopped	20°C	20.5°C	(none)	5.ON	COMPLETE	off
an Protocol F	4	OFFLI...	Disabled	Stopped	0°F	0°F	(none)	(none)	run	off

Figure 28. Network Summary Screen.

Double-click on the desired oven to open the Controller Run Time Window (Figure 29). Press **RUN** to start the manual, timer or profile mode, choose desired datalogging options.

Oven 5: Oven 14

Setpoint 20°C  
**22.1°C**  
Stopped  
Select Mode

ALARMS  
Hi-Limit 1  
Soak 2  
0 3  
Buzzer 4

OUTPUTS  
1  
2  
3  
4  
**5**

Close

RUN

STOP

HL Setp 44°C  
HL Temp 24.4°C

**OFFLINE!**

Lot Datalogs:

Start

Start

Start

Start

Start

Figure 29. Protocol Plus Controller Run Time Window.

	<p><i>The user need not log in to start or run the controller from the Run Time Window. However, the Start Running screen requires an login.</i></p>
--	--

### 4.2.1. Start Controller in the Run Time Window

The Run Time Window presents three options for starting a profile (Figure 30):

- Manual Mode
- Time Mode
- Profile Mode

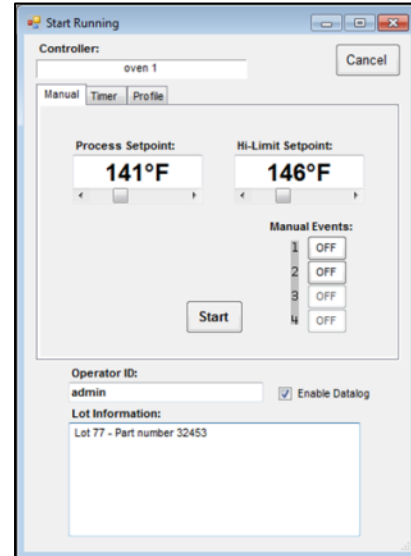

Figure 30. Run Time Window showing manual tab.

#### 4.2.1.1. Starting with Manual Mode

In Manual Mode the process run is held at a single setpoint temperature until the operator presses **STOP** (Figure 31). Enter the process setpoint, Hi-limit setpoint and event status as desired (Figure 31).

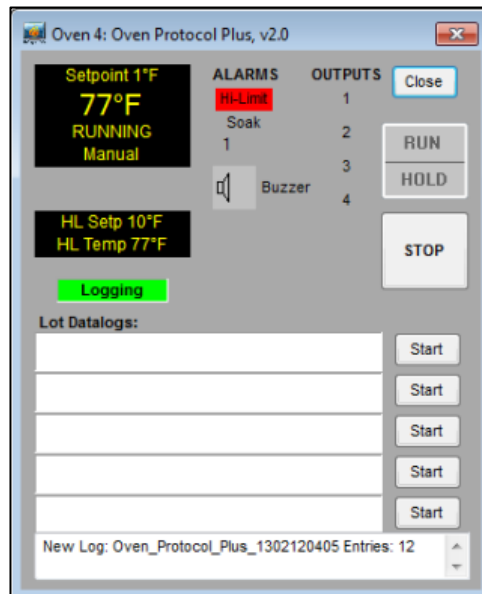

Figure 31. Run in Manual Mode.



#### 4.2.1.2. Starting with Timer Mode

Timer mode allows the operator to start and stop the process for a preset length of time (Figure 32). Timer mode is similar to Manual mode except that the time at temperature is added. If the soak band temperature deviates from this setting, the timer is placed in a hold condition.

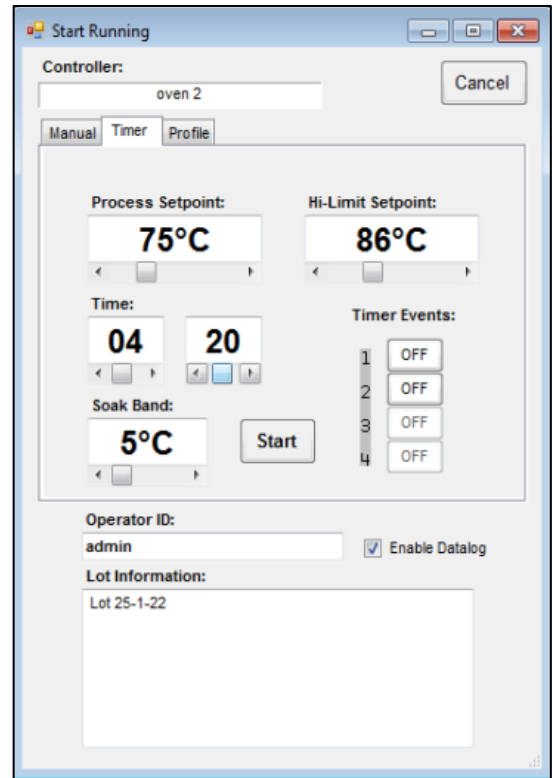

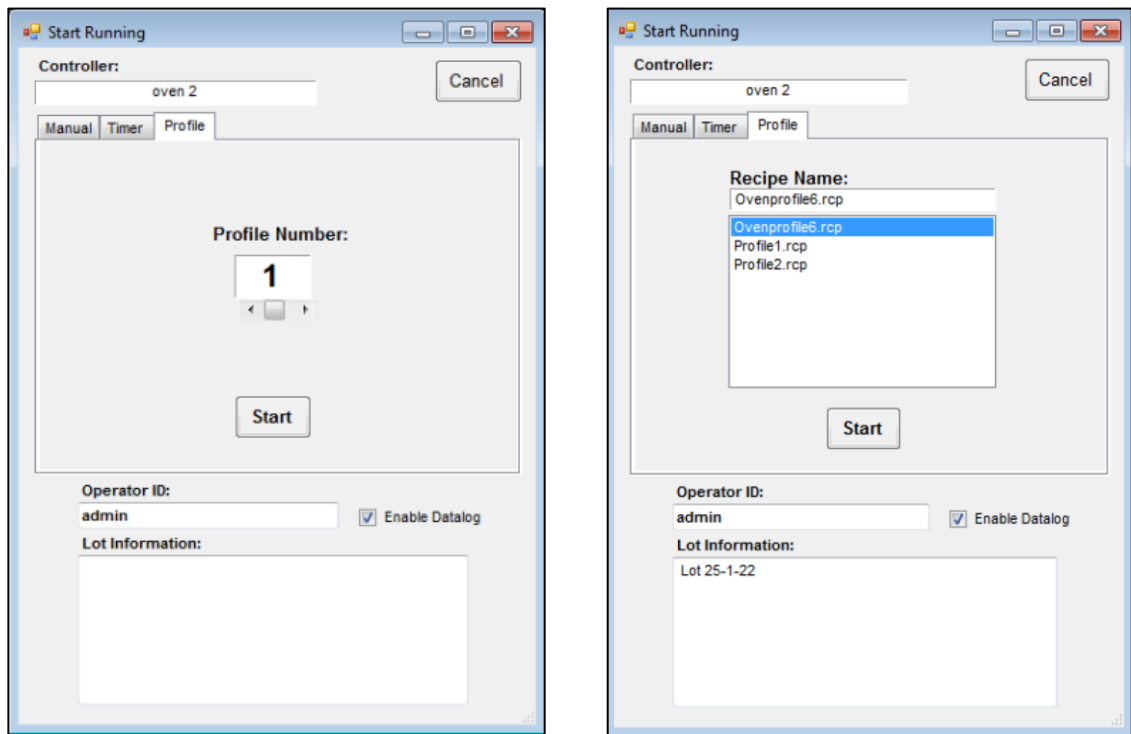

Figure 32. Run in Timer Mode.

#### 4.2.1.3. Starting with Profile Mode

Profile mode allows the user to start with one of eight separate profiles (Figure 33). Create profiles or add profiles to the system at the **Recipe Editor** Screen (refer to Section 3.7).

	<p><b><i>If a profile number is selected, but that profile has not been created and stored, the profile will not start.</i></b></p>
---	---



**Figure 33. Run in Profile Mode (typical screens).**

	<p><b><i>The list of recipes shown is created from the collection of recipes stored locally. Selecting to start a profile using a recipe from this list will first cause the recipe to be downloaded to the controller as Profile 8, then Profile 8 will be started.</i></b></p>
---	--

## 5. Troubleshooting

### 5.1. Controller Firmware Revision

Refer to the Protocol 3 Controller Owner's Manual for instructions on how to enter Product Information. Protocol Manager Software requires Version 2.3 or later firmware for the Protocol 3 controller. If the control is version 2.2 or earlier contact Despatch for a replacement.

### 5.2. Troubleshoot Controller Parameters

For problems communicating between the Protocol Manager and Protocol 3/Protocol Plus controllers, check each controller's communication page for these settings:

- **Address**
  - Assign each controller/oven using an RS422/RS485 interface a unique address.
  - Default = 1
- **Mode**
  - Set Mode to Modbus
  - Default = OFF
- **Baud Rate**
  - For problems communicating, try a lower baud rate. But start with the default baud rate.
  - Default = 19.2K
- **Parity**
  - Leave parity at the default setting
  - Default = None

Review the Protocol 3 and/or Protocol Plus manual for specific instructions on how to enter each controller's communications page.

### 5.3. Troubleshoot Protocol Manager Parameters

This process leads the user through the typical Protocol Manager settings. Use this process to ensure the correct parameters are in place.

1. Log in with the highest security level: Level 4 (Figure 34). Default password: despatch

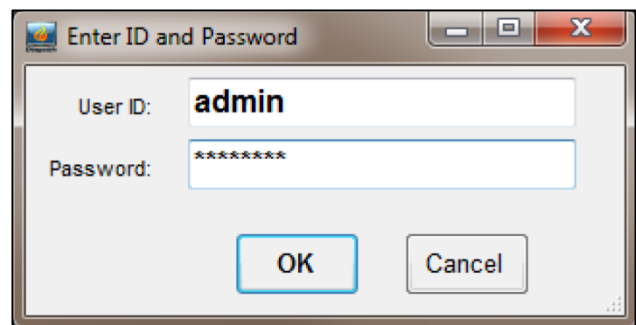

Figure 34. Log in at highest security level.

2. Click on **Window** and **Setup** (Figure 35) to get to **Comm Setup** (Figure 36).

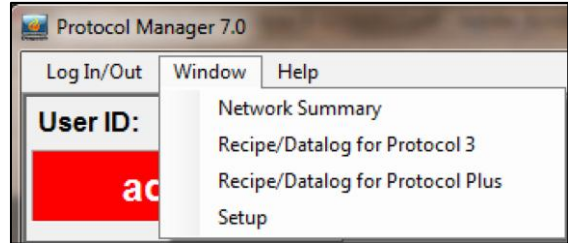

Figure 35. Window Pull Down Menu.

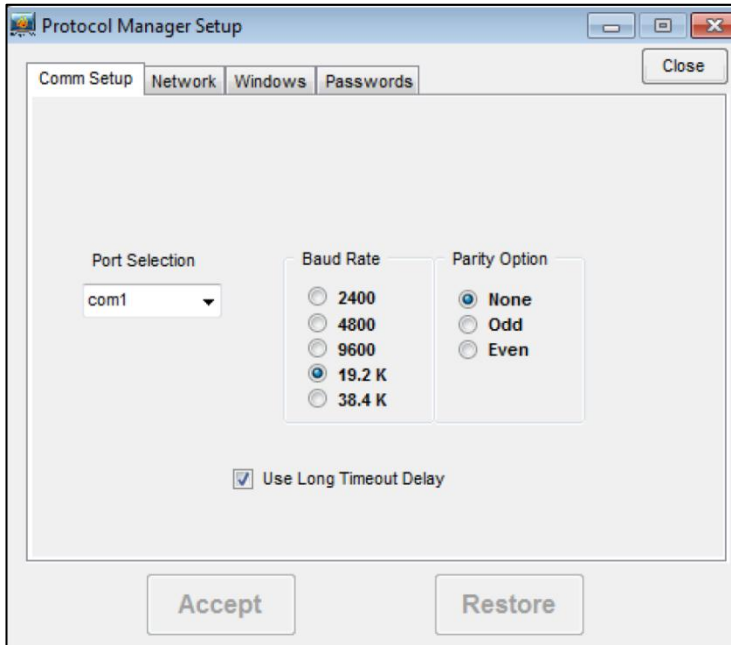

Figure 36. Comm Setup Typical Settings.

3. Click on **Network** and highlight the desired oven. Click **Edit**. Make sure addresses on the Protocol Manager screens match the addresses on each controller (Figure 37). For Protocol Plus controllers, ensure the password is set to the default (Level 2). **Enable Communication** should be enabled. Click **Set** when complete to save changes (if any).

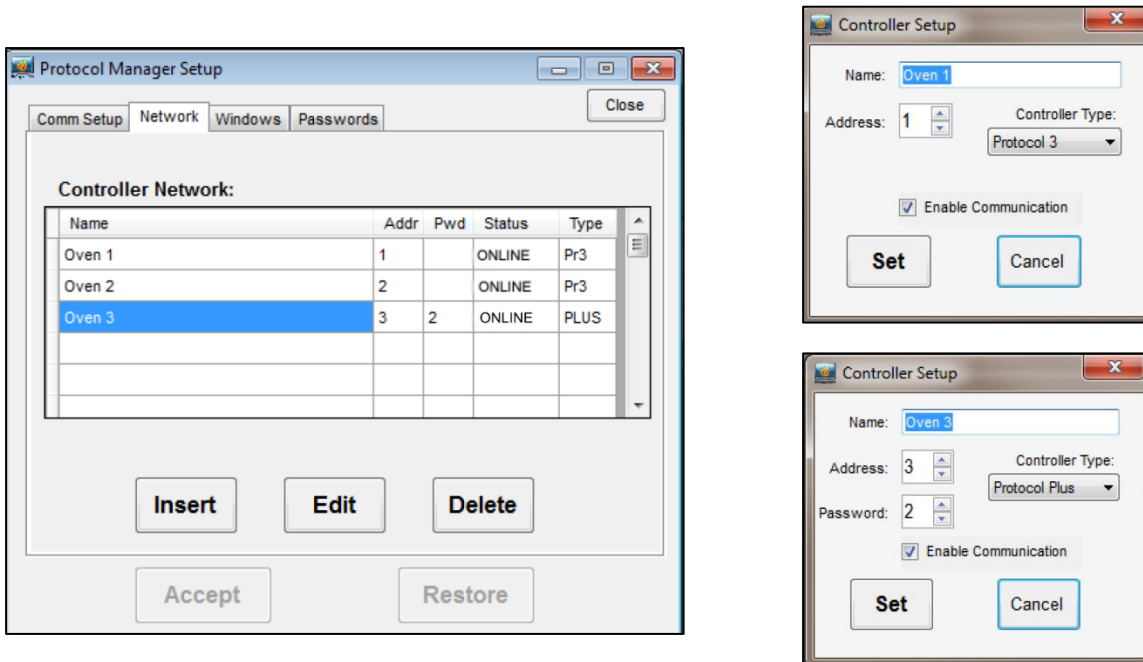

Figure 37. Check network controller parameters.

- When the Run Time Window green On-Line light comes on, communication has been successfully established (Figure 38). If Online does not light, check hardware and cabling (Section **Error! Reference source not found.**).



Figure 38. Run Time Window Online light indicates successful communication with controllers.

## 5.4. Controller Hardware and Cabling

### 5.4.1.1. Check Cabling Between Controller and Outside of Oven

In reference to Figure 39:

- The T+ should be connected to terminal #19 on the back of the controller. Check using an ohmmeter that pin #3 on the 9 pin connector connected to this terminal.
- The T- should be connected to terminal #20 on the back of the controller. Check using an ohm meter that pin #4 on the 9 pin connector connected to this terminal.

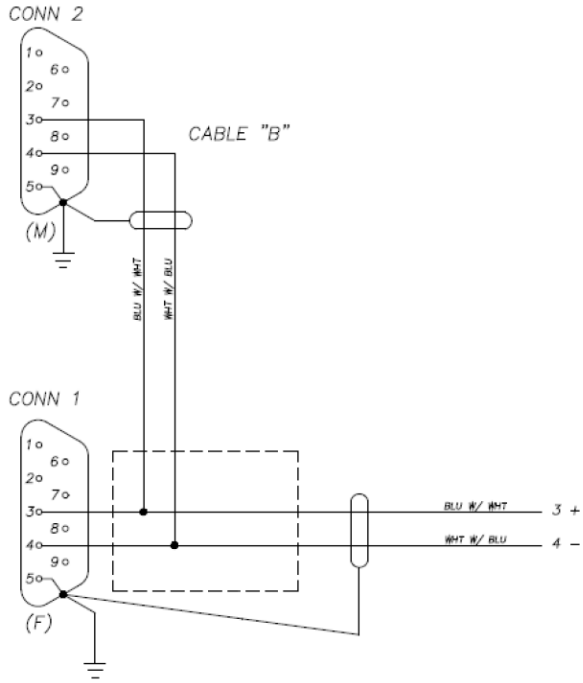

**Figure 39. Check Cabling Between Controller and Oven.**

#### **5.4.1.2. Check Cabling between Computer and Outside of Oven**

Typical wiring schemes are shown in Figure 40, Figure 41 and Figure 42 . There may be a combination of protocol plus and protocol 3 controllers. Additional ovens (maximum of 32 ovens) can be added. Contact Despatch Service for more information (see Section 1.2).

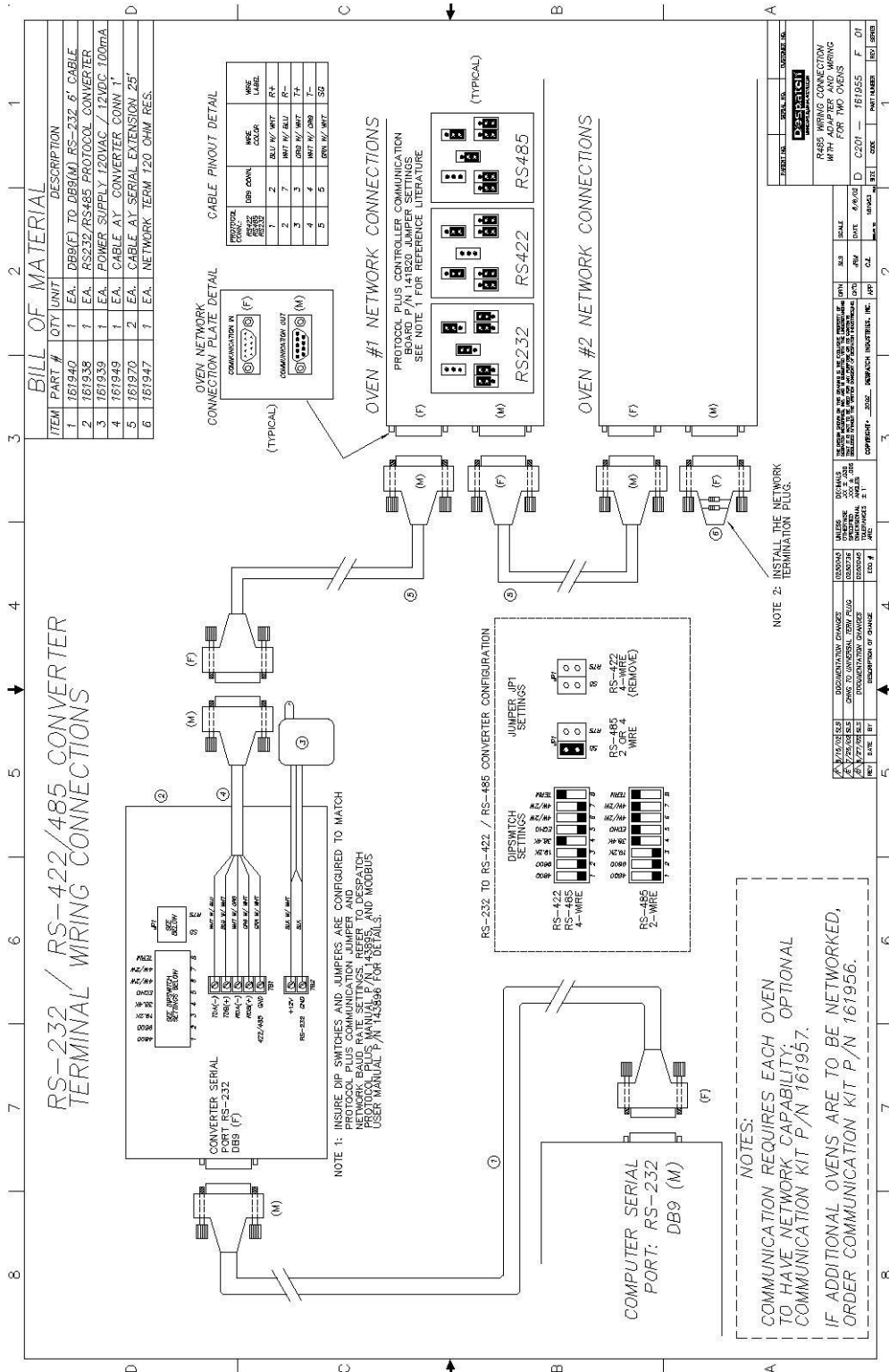

Figure 40. Older model serial converter.

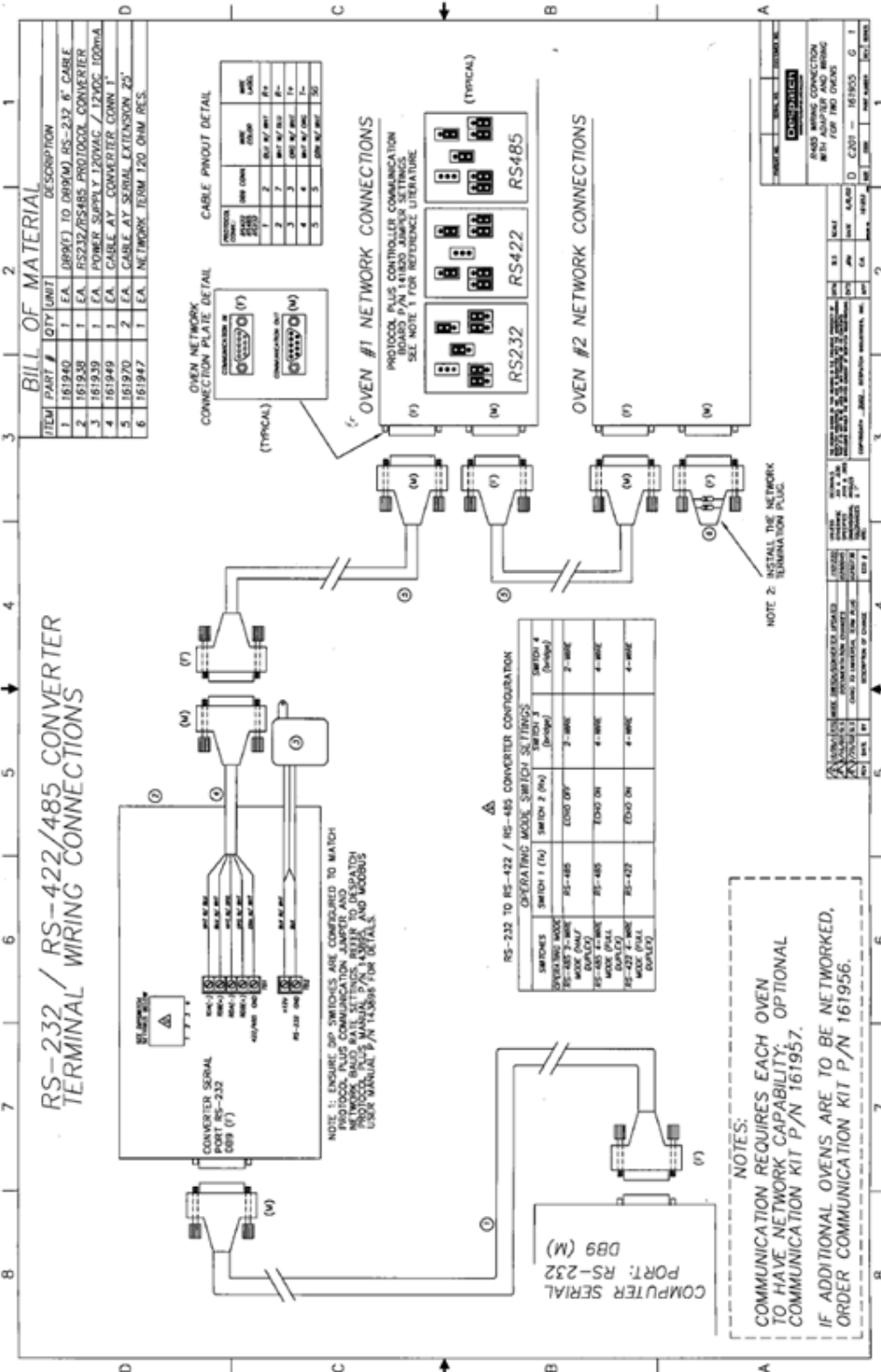

Figure 41. Newer model serial converter.



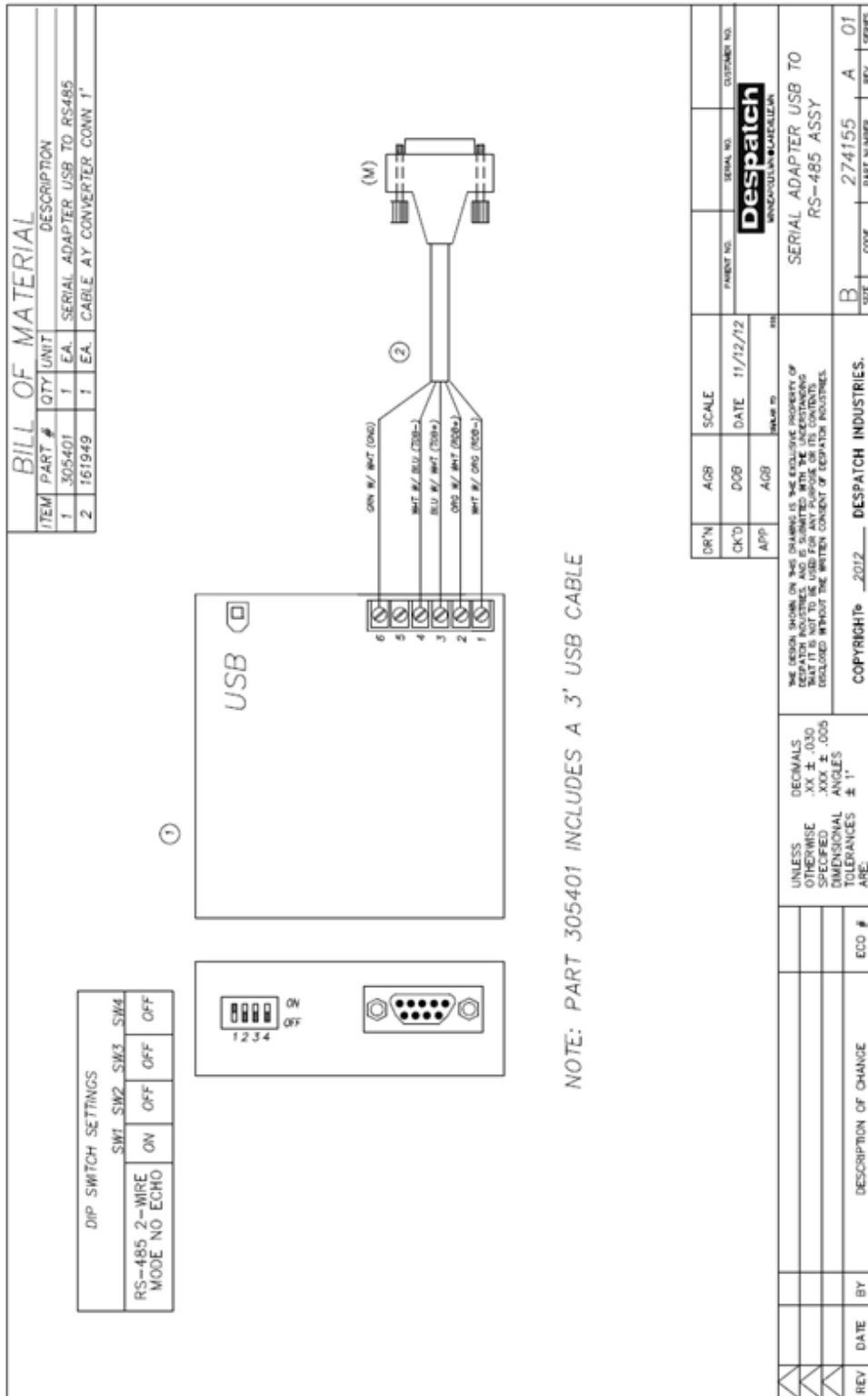

Figure 42. USB Converter.



## 6. Appendices

### 6.1. Protocol Plus Communication Card Installation And Jumper Settings

#### Notice

***Electronic components are extremely sensitive to static electricity. Before opening the controller case, read and follow the precautions below to prevent damage from static electricity.***

- 1. Turn off power to the controller.***
- 2. Touch a bare metal surface on the exterior of the controller.***
- 3. Disconnect the power connection from the controller or unplug from the power source.***

***Also follow these static electricity precautions:***

- Avoid static-causing surfaces while working with electronic components.***
- Remove parts from their anti-static bags only when ready for use. Do not lay parts on the outside of the anti-static bag because only the inside provides protection.***
- Hold circuit boards by their edges or any metal mounting hardware. Avoid touching components or connectors on the circuit boards.***

### 6.1.1. Communication Card Installation

1. Turn off power to the controller.
2. Remove the back cover of the controller by removing the two screws at the top of the unit.
3. Looking into the back of the controller with the connector terminal strips at the bottom:
  - a. Install the communication card onto the two 5 pin headers on the rear circuit board.
  - b. Be sure the jumper blocks on the communication card are positioned toward the bottom of the controller.
  - c. Refer to Figure 43 for placement information. Be sure the card is seated firmly onto the headers.

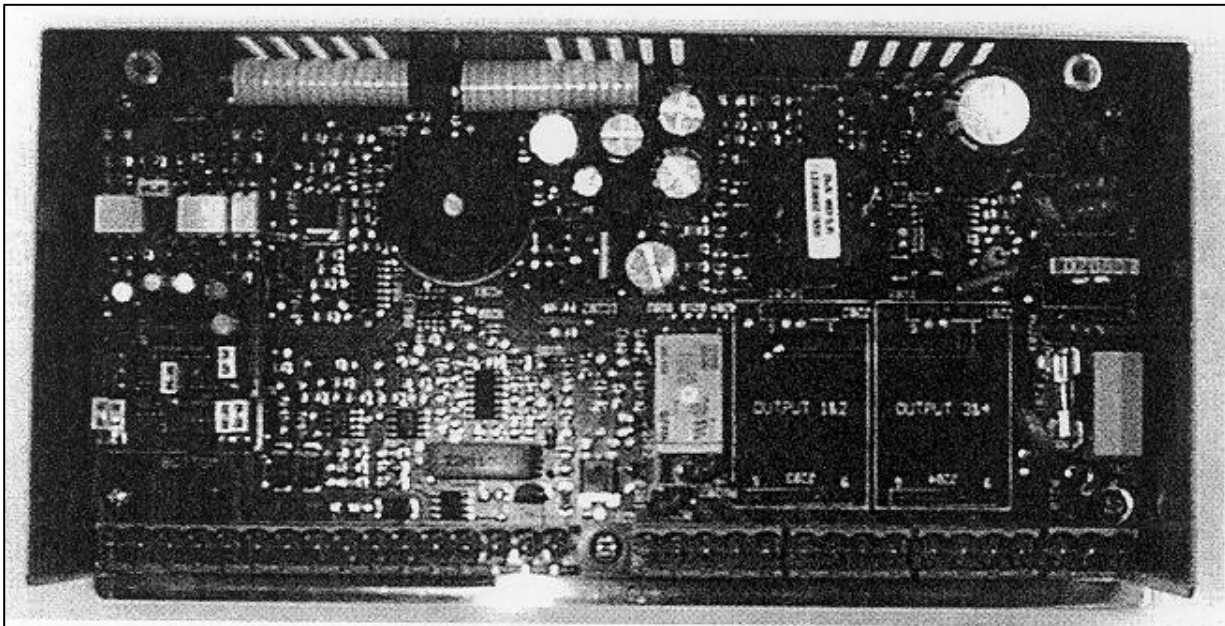

Figure 43. Controller rear view with Communications Card (left).

4. Set the jumpers on the communication card for the desired serial communication interface based on Figure 44.
5. Reinstall the back cover.
6. Wire the communication connections on the rear of the unit for the desired serial communication interface:
  - RS232 Wiring Diagram (Figure 47)
  - RS422A Wiring Diagram (Figure 46)
  - RS 485 Wiring Diagram (Figure 45)
7. Reapply all power connections to the controller.

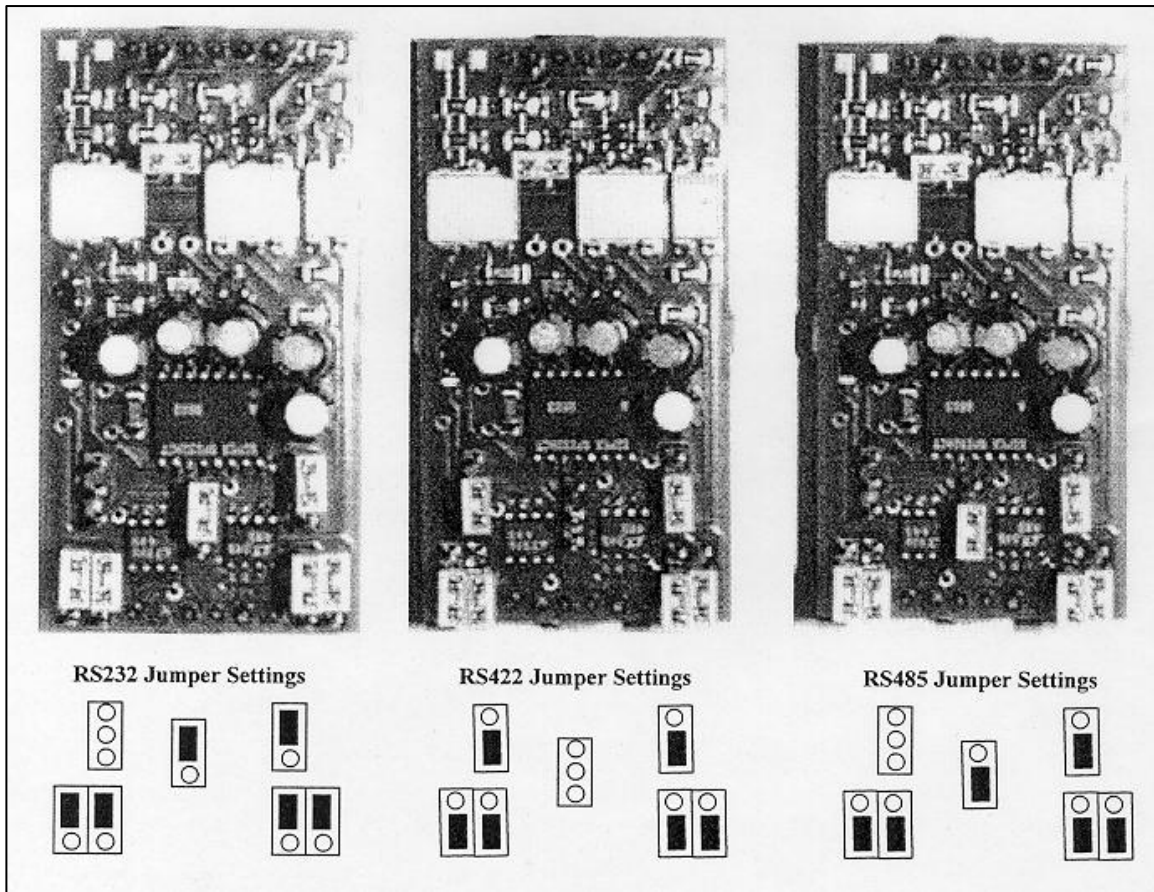

Figure 44. Communication Card Jumper Settings.

### 6.1.2. Communication Card Jumper settings.

1. Turn power to the controller OFF.
2. Remove the back cover of the controller (if it is not already removed) by removing the two screws at the top of the unit.
3. Set the jumpers on the communication card for the desired serial communication interface based on Figure 44.
4. Reinstall the back cover.
5. Reapply power to the controller.

### 6.1.3. Protocol Plus Controller Wiring Diagrams

Communication cards require different settings depending on the type of communication port used:

- RS232 Wiring Diagram (Figure 47)

Copyright © 2013 by Despatch Industries.

All rights reserved. No part of the contents of this manual may be reproduced, copied or transmitted in any form or by any means including graphic, electronic, or mechanical methods or photocopying, recording, or information storage and retrieval systems without the written permission of Despatch Industries, unless for purchaser's personal use.

- RS422A Wiring Diagram (Figure 46)
- RS 485 Wiring Diagram (Figure 45)

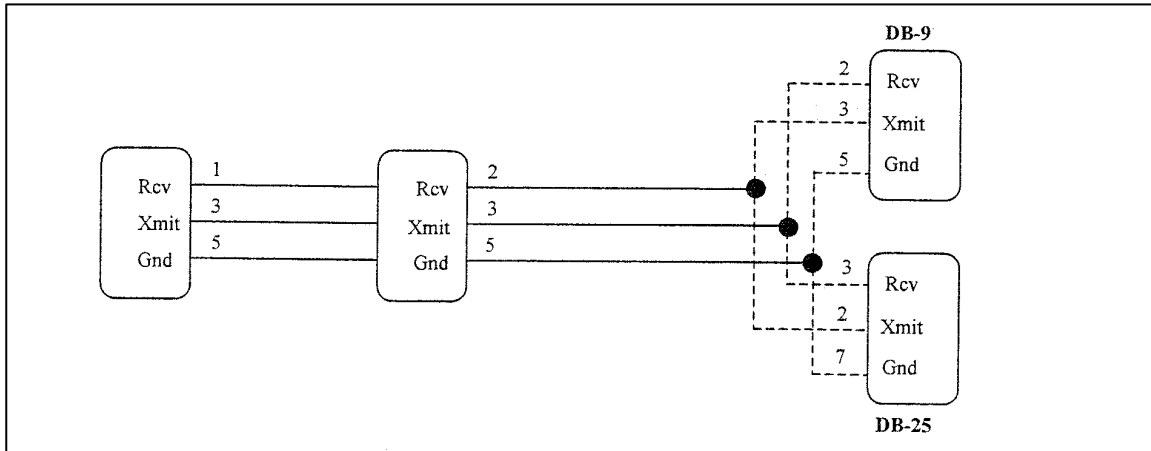

Figure 47. RS232 Wiring.

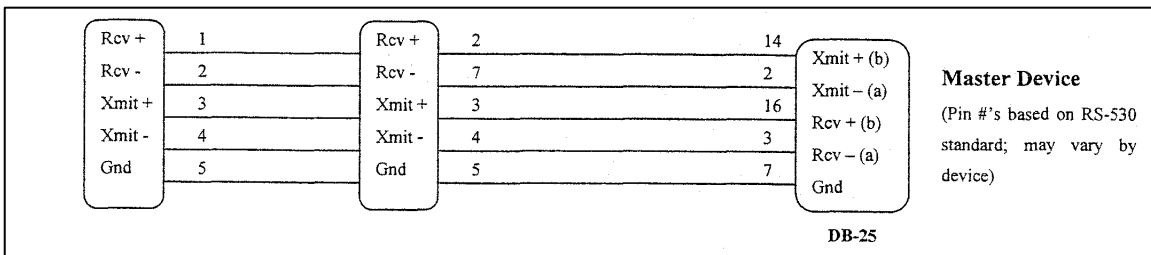

Figure 46. RS422A Wiring (4 wire).

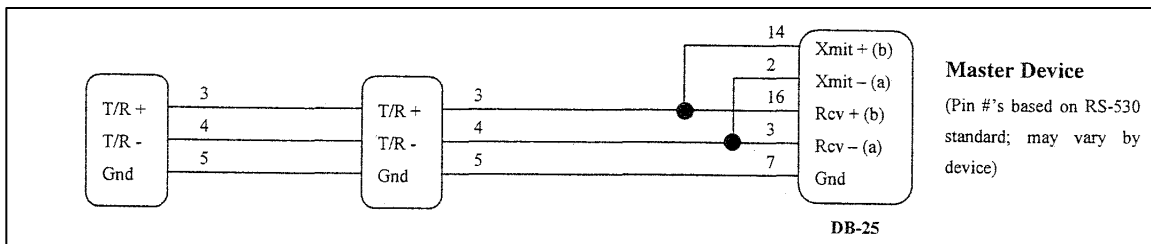



Figure 45. RS485 Wiring (2 wire).

### 6.1.4. Connecting Controllers to a Communications Host PC

	<p><i>If the ovens purchased were not supplied with communication options, order additional components (add-on Protocol Plus communication board, internal cabling, DB9 external cable connections) to make the ovens communication-ready. Order components required to network two ovens to a host PC.</i></p> <p><i>Contact Despatch Service for more information (see Section 1.2).</i></p>
---	--

#### 6.1.4.1. Overview of Networking Multiple Protocol Plus Controllers

The host PC must have its assigned RS-232 COM port connected to a RS-422/RS-485 bi-directional adapter, for example a “B&B Electronics” adapter. These P/Ns provide the adapter, power supply and PC-to-adapter serial cable. The following wiring description refers specifically to the B&B device, but may be applied to acceptable substitute devices.

The Protocol Plus controller’s optional communication card should be configured for RS-422A 4-wire connection. Set the dipswitches and jumpers on the adapter to match the communication from the host PC RS-232 COM port to the adapter. Wiring from the B&B adapter’s RS-422A RS-485 terminals is daisy-chained to each of the Protocol Plus controllers. Connect the power supply pigtail leads from the adapter wall mount transformer into the +12V and GND on the adapter. Plug the transformer into a standard 120V / 60 Hz supply outlet.

Note that the communication ready ovens are supplied with two DB9 network ports; “Communication In” and “Communication Out.”

#### **For Shorter Networking Runs**

Standard serial communication rated cables are available in a variety of lengths. Contact Despatch Service for more information (see Section 1.2).

#### **For Longer Network Runs**

RS-422A/RS-485A cables typically consist of three individually shielded twisted pairs:

- One pair transmits data from the host PC to the ovens
- One pair transmits data from the ovens to the host PC
- One conductor from the third pair is the signal common
- The remaining conductor of the third pair is unused.

Cable such as Belden type 9843 should be used.

The network requires a cable breakout junction box near each oven. 120 ohm terminating resistors must be installed at each end of the RS-422/RS-485 network (see Figure 48 for a

simplified network wiring diagram). In this case, "To Host PC" actually indicates a cable connection to the B&B adapter. The "PC Rcv" and "PC Xmit" terminals refer to the B&B adapter's RD and TD terminals respectively. Install the 120 ohm resistor between the RD+ and RD- terminals. Connect the GND wire to the 422/485 GND terminal. The remaining termination resistor is applied at the RD+ and RD- terminals of the "last in line" networked oven.

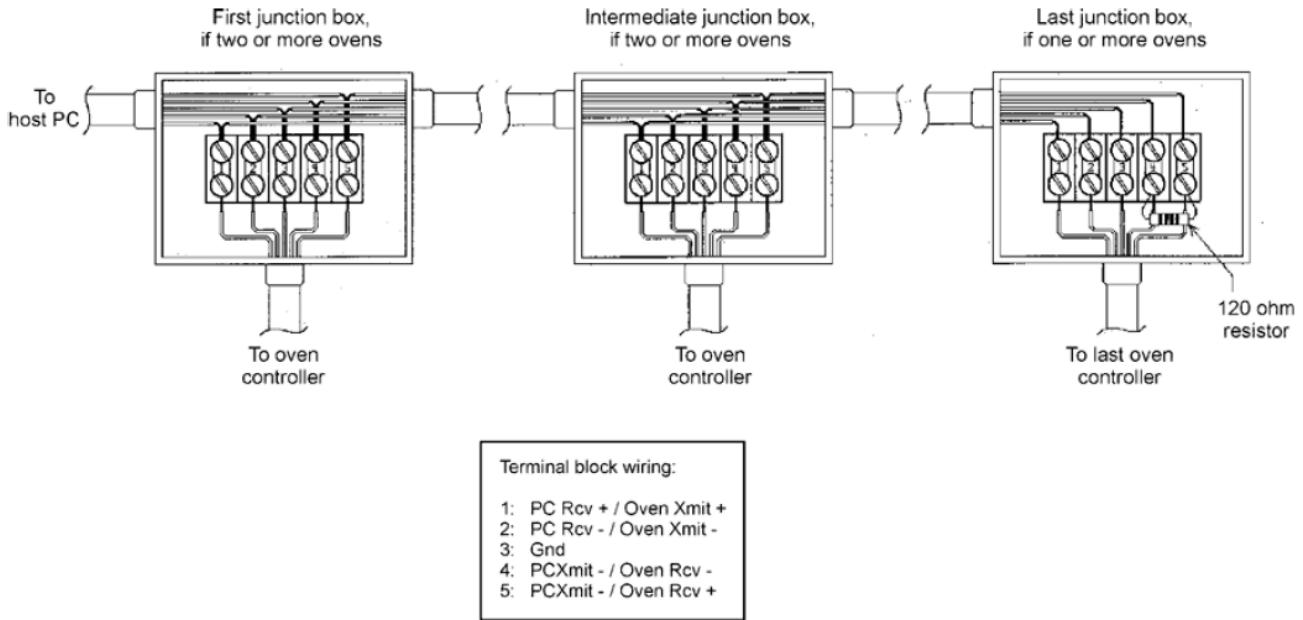

Figure 48. Junction Box Wiring.

RS-422/RS-485 allows communication over wires up to 1000 meters in length. Note that the associated runs from the oven's Protocol Plus controller to the breakout junction box should be limited to 5 meters maximum. The junction boxes provide a drop from the network cable to each oven. Terminate the cables marked "to Oven Controller" with 9-pin male subminiature "D" plug for mating with the oven controller's "Communication In" serial data receptacle.

Wire drop the cable according to Table 7.

Table 7. Networking Cable Terminal & Pin Numbers.

Oven signal	Junction box terminal	9-pin plug pin number
Rcv+	5	2
Rcv-	4	7
Xmit+	1	3
Xmit-	2	4
GND	3	5

Copyright © 2013 by Despatch Industries.

All rights reserved. No part of the contents of this manual may be reproduced, copied or transmitted in any form or by any means including graphic, electronic, or mechanical methods or photocopying, recording, or information storage and retrieval systems without the written permission of Despatch Industries, unless for purchaser's personal use.



The daisy chain drop cables may use shielded pairs. Cable shields should be connected as follows:

- At each junction box - to the box interior chassis.
- At each drop cable 9-in plug-to the lug shell if conductive.

If a non-conductive shell is used, no connection is required.

---

## SERVICE AND TECHNICAL SUPPORT

**Service parts:** 1-800-473-7373

**International service/main:** 1-952-469-8230

**Service fax:** 1-952-469-8193

service@despatch.com

## GLOBAL OFFICES

**Germany:** +49 30 629 073 410 / europe@despatch.com

**China:** +86-21-62365868 / shanghai@despatch.com

**Taiwan:** +886-3-6588484 / taiwan@despatch.com

## USA HEADQUARTERS

**Phone:** 1-952-469-5424

**US toll free:** 1-888-337-7282

**Fax:** 1-952-469-4513

info@despatch.com

service@despatch.com

[www.despatch.com](http://www.despatch.com)

8860 207th Street West

Minneapolis, MN 55044 USA

**Despatch**  
INDUSTRIES

© 2013 Despatch Industries. All rights reserved. Despatch is a registered trademark of Despatch Industries in the U.S. and other countries. No part of the contents of this manual may be reproduced, copied or transmitted in any form or by any means without the written permission of Despatch Industries, unless for purchaser's personal use.