

THRIVING ON INNOVATION

Despatch
INDUSTRIES

**LCC/LCD2-14PT-3
PASS-THROUGH SERIES
WITH PROTOCOL *PLUS*TM
INSTRUCTION MANUAL**

C-199
PN 161872
REVISION H
4/2009

SERVICE AND TECHNICAL SUPPORT

service parts: 1-800-473-7373
international service/main: 1-952-469-8230
service fax: 1-952-469-8193
service@despatch.com

GLOBAL HEADQUARTERS

phone: 1-888-DESPATCH (1-888-337-7282)
international/main: 1-952-469-5424
fax: 1-952-469-4513
sales@despatch.com
www.despatch.com

8860 207th Street West
Minneapolis, MN 55044 USA

Despatch
INDUSTRIES

MINNEAPOLIS • SHANGHAI • BERLIN • SINGAPORE • TAIPEI

NOTICE

Users of this equipment must comply with operating procedures and training of operation personnel as required by the Occupational Safety and Health Act (OSHA) of 1970, Section 6 and relevant safety standards, as well as other safety rules and regulations of state and local governments. Refer to the relevant safety standards in OSHA and National Fire Protection Association (NFPA), section 86 of 1990.

CAUTION

Setup and maintenance of the equipment should be performed by qualified personnel who are experienced in handling all facets of this type of system. Improper setup and operation of this equipment could cause an explosion that may result in equipment damage, personal injury or possible death.

Dear Customer,

Thank you for choosing Despatch Industries. We appreciate the opportunity to work with you and to meet your heat processing needs. We believe that you have selected the finest equipment available in the heat processing industry.

At Despatch, our service does not end after the purchase and delivery of our equipment. For this reason we have created the Service Products Division within Despatch. The Service Products Division features our Response Center for customer service. The Response Center will direct and track your service call to ensure satisfaction.

Whenever you need service or replacement parts, contact the Response Center at 1-800-473-7373: FAX 952-469-4513.

Sincerely,

Despatch Industries



Standard Products Product Warranty

Products Covered by this Warranty

This warranty (the "warranty") applies to the following Despatch products: LEB, LBB, LAC, LCC, LCD, LLD, RAD, RFD, LND, RTFO, TAD, TFD, PR, PN, PW, PTC and the following Ransco products: RTH, RTS, 900 Series.

Parts and Materials

Despatch warrants all parts and materials to be free from defects in material and workmanship for a period of:

1. Five (5) years from date of shipment for laboratory oven electric heaters.
2. Three (3) years from the date of shipment for Protocol Plus and DES 2000 temperature controllers; and
3. One (1) year from the date of shipment, or 2,000 hours of operation, whichever occurs first, for all other components of products covered by this Warranty.

During the applicable Warranty period, Despatch will repair or replace, at Despatch's option, parts and materials covered by this Warranty.

Labor

During the first 90 days of the Warranty period, Despatch will pay labor costs incurred to remove defective parts and materials, and to reinstall repaired or replacement parts or materials; provided, however, that Despatch's obligation to pay such labor costs shall be subject to the limitation that the removal and/or reinstallation service must be performed by a Despatch-authorized technician from Despatch's worldwide network of factory-trained professionals at a location within the contiguous United States.

Transportation Costs

All transportation costs to transport defective parts or materials to Despatch and to transport repaired or replacement parts or materials to Customer shall be the responsibility of Despatch.

Terms and Conditions

This Warranty shall be deemed valid and binding upon Despatch if and only if the Customer:

1. Installs, loads, operates, and maintains the covered product supplied hereunder in accordance with the instruction manual provided upon delivery and product labeling affixed to the subject equipment;
2. If applicable, follows the Emergency Procedure set forth in this Warranty; and
3. Contacts Despatch's Helpline at 1-800-473-7373 for assistance in diagnosing and troubleshooting the problem immediately upon discovering any damage or malfunction.

Despatch's reasonable determination as to whether a repair, replacement, or service is covered by this Warranty shall be final and binding.

Exclusions

This Warranty DOES NOT cover,

1. Damage or malfunctions, or expenses incurred in the process of diagnosing and/or repairing damage or malfunctions, resulting from any of the following: operator

error, misuse, abuse, inadequate preventative maintenance, normal wear and tear, service or modifications by other than Despatch authorized technicians, use of the covered product that is inconsistent with the operation manual or labeling, acts of nature (including, without limitation, floods, fire, earthquake, or acts of war or civil emergency), internal or external corrosion, or non-conforming utilities (including, without limitation, electrical, fuel supply, environmental and intake/exhaust installations);

2. Repair or replacement of parts or materials designed and intended to be expendable or consumable; refrigerants, filters, lamps;
3. Routine maintenance; or
4. Labor costs incurred for troubleshooting, diagnostics, or testing (except for testing required to verify that a covered defective part or material has been repaired).

Limitations of Liability

Despatch shall not, in any event, be liable for indirect, special, consequential, incidental, or punitive damages or penalties of any kind, including without limitation loss of revenue, profits or business opportunities resulting from interruption of process or production. In no event shall Despatch be liable for damages in excess of the amounts paid by Customer to Despatch with respect to the applicable product(s). This Warranty does not cover, and Despatch shall not be liable for any losses, costs, damages or expenses resulting from delays in diagnosing or repairing the products, supplying or obtaining replacement parts of materials, strikes, labor stoppages or shortages, fires, accidents, government acts or regulations, or any other causes beyond the control of Despatch.

Non-Compliance By Customer

Despatch reserves the right to suspend and withhold service under this Warranty in the event of non-compliance by the Customer to any terms and conditions of this Warranty or the applicable purchase order or invoice. Further, Despatch shall not be liable for any loss of production, expenses, and inconveniences incurred due to such suspension.

Customer Furnished Equipment Warranty Limitation

This Warranty does not cover diagnosis or repairs of defects in or caused by, lack of performance of, or fitness for purpose of customer-supplied parts or equipment unless specifically noted in the Despatch written order acceptance confirmation.

Performance Commitment

Despatch provides no guarantee of process performance or fitness for purpose, unless specifically noted otherwise in Despatch written order acceptance confirmation. Despatch is providing equipment with design parameters specific only to its equipment.

Procedure Upon Discovery of Defects and Emergencies

In the event Customer becomes aware of any defect in the application products, Customer must immediately: (a) shut off fuel or energy supply (gas and electricity); (b) call for emergency assistance, if needed, and (c) notify Despatch Service.

THE REPRESENTATION AND WARRANTIES SET FORTH HEREIN ARE EXCLUSIVE AND IN LIEU OF, AND CUSTOMER HEREBY WAIVES AND DISCLAIMS RELIANCE UPON, ALL OTHER REPRESENTATIONS AND WARRANTIES OF EVERY KIND WHATSOEVER WHETHER EXPRESS OR IMPLIED, OR ARISING BY OPERATION OF LAW OR IN EQUITY, OR BY COURSE OF PERFORMANCE OR DEALING OR USAGE OF TRADE, INCLUDING, WITHOUT LIMITATION, ANY IMPLIED WARRANTIES OF MERCHANTABILITY OR OF FITNESS FOR A PARTICULAR PURPOSE.

THIS WARRANTY IS PERSONAL TO THE CUSTOMER AND MAY NOT BE TRANSFERRED OR ASSIGNED. ALL LIMITATIONS HEREUNDER, HOWEVER SHALL BE BINDING ON ALL SUCCESSORS AND ASSIGNS OF CUSTOMER.

Service

Worldwide Phone 952-469-8230; Worldwide Fax 952-469-8193; North American Phone 800-473-4373
e-mail service@despatch.com; www.despatch.com

Please see reverse side for other service offerings

Despatch Industries

Advantage Service Assurance Program (ASAP)

CONTACT: DESPATCH SERVICE AGREEMENTS SPECIALIST at 800-473-7373 or 952-469-8230
or e-mail: service@despatch.com

Despatch continues to deliver exceptional products backed by a strong sense of responsibility and drive for long term customer satisfaction. Your partnership with Despatch can offer even higher value through your subscription to one of Despatch's Advantage Service Assurance Program(ASAP).

Warranty

Despatch's exclusive, comprehensive service programs start with the 1 year parts only warranty which is described on the other side of this document. This warranty can be expanded immediately to meet your most stringent service needs. Despatch Service Products Group will be able to answer your service questions and provide a quotation for the immediate expansion of your product warranty. Call 800-473-7373 or 952-469-8230; or e-mail service@despatch.com.

Immediate Service Response

The key to an effective service program is response. Wherever your location, Despatch is only a phone call away. Our U.S. and Canadian customers can reach Despatch at 1-800-473-7373. Worldwide customers can call 1-952-469-8230 or FAX 1-952-469-8193. Our Customer Service Technicians have over 150 years combined experience and access to detailed design and manufacturing documentation specific to your Despatch unit(s). This exacting level of service is a benefit only Despatch can provide and means that you can expect speedy, accurate and the most cost effective response.

Field Service Network

A worldwide network of factory trained Service Professionals is available to support your Despatch equipment. From routine repair to certified instrument calibration, the Despatch service network is positioned to respond to your needs. As a manufacturer of custom equipment, our service programs are customized to meet your specific needs regarding:

1. Service scope
2. Response time
3. Preventive maintenance frequency and content
4. Payment method

Sustained Service Support

At Despatch, long term customer satisfaction means more than just responding quickly and effectively to our customers' service needs. It means offering comprehensive customer support well beyond the scope and duration of our initial warranty. Despatch offers two basic service packages which are customized to each individual customer's need. These service packages are titled Full Service and Preventive Maintenance Plus+ service agreement products. Each is unique in the industry and offer the following benefits:

1. Priority response for minimum production interruption
2. Preventive maintenance for longer product life
3. Discounts on parts and services
4. Various payment plans to ease budgeting and recording expenses
5. Reduce purchase ordering costs

Service

Worldwide Phone 952-469-8230; Worldwide Fax 952-469-8193; North American Phone 800-473-7373
e-mail service@despatch.com; www.despatch.com

Despatch

INDUSTRIES

8860 207th Street West, Lakeville MN 55044

Declaration of Conformance

Manufacturer's Name: Despatch Industries
Manufacturer's Address: 8860 207th Street West
Lakeville, Minnesota 55044 U.S.A.

declares that the product:

Product Name: Laboratory Oven
Model or Drawing Number(s): LCC...-3/LCD...-3
Sizes: 2-14PT

conforms to the following standards:

EN 60204-1:1998
NEC- National Electrical Code (NFPA 70)
NFPA 86- Standard for Ovens and Furnaces

Supplementary Information:

The product complies with the requirements of the:

- Machine Directive – 98/37/EC
- Low Voltage Directive – 73/23/EEC
- EMC Directive – 89/336/EEC

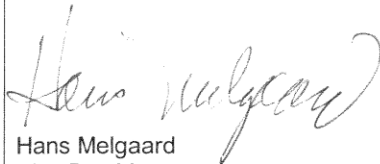

Hans Melgaard
Vice President
Despatch Industries
8860 207th Street West
Lakeville, Minnesota 55044

Date: April 6, 2005

Despatch
Thermal Processing
Systems

www.despatch.com • 952.469.5424 • fax 952.469.4513
Lakeville • Detroit • Oxnard, CA

RANSCO
Environmental Test and
Simulation Equipment

PREFACE

This manual is your guide to the Despatch LCC/LCD2-14PT-3 SERIES pass-through ovens. It is organized to give you the information you need quickly and easily.

NOTE: Read the entire INTRODUCTION and THEORY OF OPERATION before installing the oven.

The INTRODUCTION section provides an overview of the oven.

The OVEN OPERATION section details the function and operation of assemblies and subassemblies on the oven.

The INSTRUCTIONS section provides directions on unpacking, installing, operating and maintaining the oven.

An efficient way to learn about the oven would be to read the manual while working with the corresponding oven control system. This will give you practical hands-on experience with information in the manual and the oven.

Before operating the equipment, be sure you understand all of the technical information contained in this manual. Information skipped, not understood or misunderstood could create the possibility of operating the equipment in an unsafe manner. This can cause damage to the oven or personnel or reduce the efficiency of the equipment.

WARNING: Failure to heed warnings in this instruction manual and on the oven could result in personal injury, property damage or death.

Revision A (6-02): Initial Creation

Revision B (11-02): Update drawings, add line connection detail.

Revision C (9-03): Update drawings.

Revision D (1-04): Update to software revision 4.0

Revision E (8-06): Revised Protocol Plus numbers. Updated Despatch address.
Updated CE documents

Revision F (4-07): Updated Set-up to include water cooling installation.

Revision G (11-07): Updated warranty

Revision H (4-09): Updated Controller Instructions

TABLE OF CONTENTS

PREFACE	iii
INTRODUCTION.....	1
Features	2
Options	2
SPECIFICATIONS	3
Electrical Specifications	3
Physical Specifications	4
Functional Specifications	4
INSTRUCTIONS	5
Unpacking and Inspection	5
Set-up.....	6
Wiring	8
HEPA Filter Installation.....	9
HEPA Filter Burn-off.....	10
Filter High Limit	12
OVEN OPERATION.....	13
Oven.....	13
System Control	14
HEPA Filters	17
HEPA Filter Validation Testing.....	18
Filter Unit Replacement.....	19
HEPA Filter / Magnehelic Pressure Gauge	20
HEPA Filter Preventative Maintenance Table.....	20
OPERATING	21
Loading the Oven	21
Pre-Startup Checklist.....	22
Operating Procedure	23
Starting the Oven	23
Sequence of Operation (system using Beacon Light)	24
High Limit Alarm with Alarm Silence	25
Maintenance	26
Checklist	26
Lubrication	26
PROTOCOL PLUS CONTROL	27
Theory of Control Operation	27
Operating Modes.....	29
Setup Mode.....	29
Fast Start Mode.....	29
High Limit	30
Indicators	30
Displays	31
Key Functions	31
Outputs	32
Relay (Continued)	33

Communication	33
Optional Software.....	33
INSTRUCTIONS	34
Start-Up	34
Operation.....	35
Manual Mode	35
Timer Mode	36
Profile Mode	37
Auto Start Mode	37
Setup Mode.....	38
Instructions for Setup Mode Pages.....	39
Program Page	39
Sample Profile.....	42
Auto Start Page.....	43
PID Page.....	45
Control Page	46
Communication Page (optional)	47
Real Time Clock Page	47
Relay Outputs Page (optional)	48
Test Page.....	49
Zone Calibration Page	50
Sensor Calibration Page	52
Enable Page	55
Digital Inputs (optional)	56
Error Messages and Alarms	57
Quick Reference and Default Values.....	58
Technical Specifications	65
APPENDIX: DRAWINGS	66

INTRODUCTION

The LCC/LCD2-14PT-3 SERIES pass-through oven is equipped with sterile and non-sterile doors, for clean room operation. Safety interlock switches on each door prevents both doors to open at the same time (these may be manually overridden if required). The operator loads the product from the non-sterile side, and selects the program to run. At the end of the process, the product is unloaded from the sterile side.

The LCC/LCD2-14PT-3 SERIES pass-through oven offers HEPA filtration for processes where minimization of contamination is essential. The removable HEPA (High Efficiency Particulate Air) filter is designed to provide a constant flow of 99.97% clean air to the product being heated. The HEPA filter with silicone seal provides 99.99% filtration prior to filter burnoff. A magnehelic differential pressure gauge monitors pressure drop across the HEPA filter.

The LCC2-14PT-3 Series ovens are rated up to 260°C, and the LCD2-14PT-3 Series has a maximum temperature of 350°C.

Atmosphere	Max Temp °C	Model
Air	260	LCC2-14PT-3
Air	350	LCD2-14PT-3

The voltages available are 208V, 240V, 415V, and 480V, 3 Phase; with a 16kW heater.

The oven's main operator interface components are on the hinged control panel located on the non-sterile side. The power components; fuse blocks and motor starters are located on the equipment panel, behind the hinged control panel for easy access. The transformer and the heater SSR's are located in the lower compartment with the recirculation and exhaust/cooling motors. An EMO (emergency off) switch, and indicator lights showing what step the process is in, is located on the sterile side control panel. Electrical components are either touch-proof or are shielded with Lexan to prevent accidental exposure during maintenance and troubleshooting.

The optional Despatch Protocol Manager software is used to enable customer PC control of an oven. Despatch Protocol Plus controllers may be networked together with a Modbus communication option when multiple ovens are operated.

Features

Despatch Protocol Plus microprocessor-based digital programmable control, with simultaneous digital readout of both setpoint and actual temperatures.

- CE compliance, including yellow and red disconnect switch/EMO mounted in the front control panel door.
- Manual reset high-limit control.
- Proportioning temperature control using solid state relays.
- Four (4) inches of insulation minimizes heat loss, external thermal spots and air leakage.
- Stainless steel exterior and interior, with all interior seams continuously welded on the insulation side to protect the work chamber from contamination.
- Horizontal airflow, which achieves air temperature uniformity of +/- 1% of operating temperature.
- Recirculation motor is mounted in the machinery compartment underneath the oven, providing convenient access.
- Indicator lights on the sterile side showing cycle status, and alerting operator if non-sterile door is open.
- Electrical door lock switch on each door prevents operator from opening chamber door when cycle is in process or having both doors open at the same time. Door lock switch has manual override for authorized maintenance personnel to release door in case of power failure.

Options

- Beacon light option on control panel provides visual cycle process indication to operator (red/amber/green)
- High-limit alarm/alarm silence switch option
- Recorder option
- Modbus RS422/485 communications option to Protocol Plus controller

SPECIFICATIONS

Electrical Specifications

If your line voltage is much lower than the oven voltage rating, heat up time is significantly longer and motors may overload or run hot. If your line voltage is higher than the nameplate rating, the motors may run hot and draw excessive amps. If the line voltage varies more than 10% from the oven voltage rating, some electrical components such as relays, temperature controls, etc. may operate erratically. Power connection is performed by the user.

VOLTS	AMPS	PHASE	HERTZ	HEATER
208	50.5	3	50/60	16 kW
240	44.5	3	50/60	16 kW
415	25.2	3	50	16 kW
480	22.2	3	60	16 kW

WARNING: Do not use any flammable solvent or other flammable material in this oven. Do not process closed containers of any substance or liquid in this oven because they may explode under heat.

NOTE that this oven is not intended to process solvents or other volatile or flammable materials. The oven's forced exhaust is intended for cooling purposes **ONLY**.

WARNING: Do not use the oven in wet, corrosive or explosive atmospheres unless this oven is specifically designed for a special atmosphere.

WARNING: Failure to heed warnings in this instruction manual and on the oven could result in personal injury, property damage or death.

Physical Specifications

	ENGLISH	METRIC
CHAMBER VOLUME	14 cubic feet	396 liters
INTERNAL DIMENSIONS *	25.5" W x 26"D x 37" H	65 cm W x 66 cm D x 94 cm H
EXTERNAL DIMENSIONS	48" W x 40 " D x 71 " H	122 cm W x 102 cm D X 180 cm H
SHELF SUPPORTS	Quantity 11 on 3" centers	Quantity 11 on 7.6 cm centers
SHELF LOAD CAPACITY	50 pounds	22.6 kg
CHAMBER LOAD CAPACITY	400 pounds	181 kg
NET WEIGHT	955 pounds	433 kg
SHIPPING WEIGHT	1050 pounds	476 kg
RECIRCULATION FAN	950 cfm	27 cmm

* Clear width reduced to 24" (61cm) by shelf supports.

Functional Specifications

MODEL	ATMO-SPHERE	OPERATING RANGE	HEATING TIME TO TEMP (minutes, w/no load)				COOLING TIME TO TEMP (minutes, w/no load)				TEMPERATURE UNIFORMITY AT				CONTROL STABILITY
			50-100°C	50-175°C	50-260°C	50-350°C	100-65°C	175-65°C	260-65°C	350-65°C	100°C	175°C	260°C	350°C	
LCC/LCD 2-14 PT3	AIR	60°C - 260°C	3	9	15	35	41	82	95	117	±1°C	±2°C	±3°C	±3.5°C	±0.5°C

1. Uniformity figures are based on a nine-point test conducted in an empty oven with thermocouples positioned at 3" from walls, and after the oven temperature has reached stabilization (typically 30 – 60 minutes). Uniformity can vary slightly depending on unit and operating conditions.
2. Operating temperatures and cooling times are based on a 20°C ambient temperature measured at the fresh air inlet.
3. Exhaust fan specification is 85 cfm.

INSTRUCTIONS

The INSTRUCTIONS section provides directions on unpacking, installation, operation and maintenance of the Despatch LCC/LCD2-14PT Series pass-through ovens.

Unpacking and Inspection

Remove all packing materials and thoroughly inspect the oven for damage of any kind that could have occurred during shipment.

- See whether the carton and plastic cover sheet inside carton are still in good condition.
- Look at all outside surfaces and corners of the oven for scratches and dents.
- Check the oven controls and indicators for normal movement, bent shafts, cracks, chips or missing parts such as knobs and lenses.
- Check the door and latch for smooth operation. (Use a hollow point torx tip tool and rotate 90 degrees counterclockwise the manual override in the safety switch. It must be turned back to the locked position to allow electrical operation.)
- Check the filter carton for damage.

If there is damage that could have happened during shipment follow these instructions:

1. Contact the shipper immediately and file a written damage claim.
2. Contact Despatch Industries to report your findings and to order replacement parts for those that were damaged or missing. Please send a copy of your filed damage claims to Despatch.
3. Check the packing list to make sure you have received all the specified components of the oven system. If any items are missing, contact Despatch Industries to have them forwarded to you.
4. Complete the warranty card and mail it to Despatch within 15 days after receipt of the equipment.

Set-up

1. Select the location for installing your oven.
2. Make sure the oven is level and plumb; this will assure proper heat distribution and operation of all mechanical components.
3. This oven has been designed for use in a clean room environment (sterile and non-sterile rooms).
4. The oven has a four (4) inch diameter exhaust opening and is located on the left side of the oven. The oven may be placed next to another cabinet on its right, or next to another oven, with three-quarters of an inch clearance (measure with door open). Exhaust air may reach 260° C on the LCC version and 350° C on the LCD version. Make sure exhaust piping materials can withstand these temperatures.
5. (Water Cooled Models) Install water connection for cooling coils to the inlet marked "Water Inlet." Verify the valve on the flow meter is turned off (fully clockwise). The water supply to the oven must not exceed 100 PSI. It is recommended to install a regulator to prevent any surge. Check for leaks. Slowly open the valve on the flowmeter and allow any air to bleed out. Failure to do this will result in damage to the flowmeter. Repeat this procedure if water supply is shut off. Adjust the flowmeter to 3 gpm (recommended amount of flow).
6. (Water Cooled Models) Make the drain connection at the side of the oven. Note there are two drain connections: water outlet and water drain. Note the water outlet may be connected in a closed loop system, but the water drain must be left in an open-to-atmosphere condition.
7. (Water Cooled Models) Connect the compressed air supply line to the inlet marked "Dry Air". The compressed air supply should run at 70 PSI but not more than 80 PSI. Check for leaks.

WARNING:

Do not use the oven in wet, corrosive or explosive atmospheres unless this oven is specifically designed for a special atmosphere.

WARNING: Do not use any flammable solvent or other flammable material in this oven. Do not process closed containers of any substance or liquid in this oven because they may explode under heat.

CAUTION:

Design the drain system to prevent operator injury from high temperature or pressure buildup. Piping must be able to withstand short periods of up to 650 °F (343 °C) temperatures. Drain lines should be insulated and/or warning labels installed that a hazard exists.

WARNING:

Never allow drain to be plugged as a hot oven will generate a small amount of steam when the water is first turned on. **STEAM BURNS!**

LCC/LCD2-14-3 WITH WATER COOLING UTILITY



Clean Dry Air Inlet. 70 to 80 PSI (4.83 to 5.52 Bar). Used to purge water out of the coil prior to heating the oven. 3/8" NPT female brass connections are provided.

During cooling cycle, water flows through the water coil and out this connection. 3/8" NPT female brass connections are provided. Piping must be rated for up to 257°F (125°C)

At the end of a cooling cycle, Clean Dry Air is purged through the water coil. Water and pressurized nitrogen/air exit this connection for 30 seconds. Must be connected to gravity style drain (no backpressure). 3/8" NPT female brass connections are provided. Piping must be rated for up to 257°F (125°C).

Water Inlet for cooling. 3/8" NPT female brass connections are provided. Requires 3 GPM flow at 55°F (13°C) to meet published cooling rates. MAXIMUM PRESSURE 100 PSI (6.89 Bar)

Wiring

NOTE: The oven must be directly hardwired to the disconnect switch on the equipment panel. A one (1) inch conduit run is provided from the left side of the lower oven compartment to the front equipment panel, through which the line voltage power wiring can be connected to the disconnect switch labeled **LINE CONNECTION** in the front of panel. Consult the electrical drawings included with the oven for wiring details. All wiring to be completed by properly trained and licensed personnel.

WARNING:

All grounding and safety equipment must be in compliance with applicable codes, ordinances and accepted safe practices.

LCC/LCD2-14-3 LINE CONNECTION DESCRIPTION (ALL SERIES)

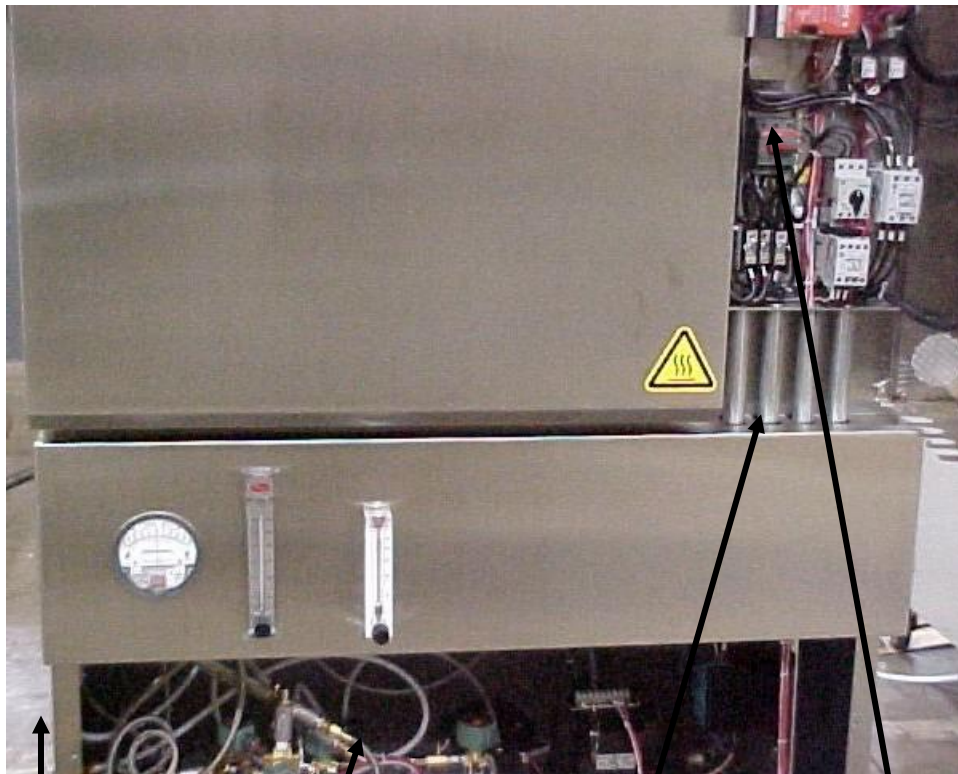

Hole for conduit fitting provided on side of oven for customer power.

Power wires are routed through this compartment.

Power wires are routed through this unused conduit to main equipment panel.

Power wires are connected to this disconnect switch and ground bus. Approximately 84" (2.13 meters) of wire length is required from the entrance on left side of oven to these connections.

HEPA Filter Installation

Technicians responsible for installing the filter should use caution. The filter is delicate and must not be damaged during installation. Any filter unit dropped, whether or not in the carton, should be examined for damage. Equally important, the filter unit must be installed so that unfiltered air will not leak past the unit.

WARNING: Make certain that power is disconnected from the oven before removing or replacing the HEPA filter.

1. Remove the filter from the carton.
 - a. Place the carton on the floor. The floor must be clear of nuts, bolts, and similar protrusions, which would damage the face of the unit. Do not drop or jar the carton.

WARNING: Repairing the damaged filter unit, particularly the medium, should not be attempted by the user. Any unit so repaired must be retested to assure that hidden damage does not exist which will reduce filtering efficiency. Repair and retest is uneconomical for most users.

- b. Tilt the carton on one corner. Be sure to handle the carton at opposing corners.
 - c. Remove the sealing tape and fold the flaps of the carton back.
 - d. Gently upend the filter to place the exposed end of the filter on the floor. Do not jar the filter.
 - e. Pull the carton from the filter unit. Do not pull the filter from the carton.
2. Inspect the filter. Use a strong lamp to examine the exposed areas of both faces to assure that no breaks, cracks, or pinholes are evident. A flashlight, can be used in a darkened room.
 - Look for visible defects with the light projected along the full length of each channel created by the separators. Translucent spots may not necessarily indicate holes or cracks but may simply be variations in thickness of the filter medium.
 - Check that the adhesive seal around the filter unit faces are complete and unbroken.
 - Check the corner joints of the frame for adhesive sealing and tightness.

- Check that the gaskets are cemented firmly to the filter frame and that the gasket pieces are butted or mated at the joints.
3. Pull the shelf out from the oven and set it aside.

WARNING: Make certain that power is disconnected from the oven before removing or replacing the HEPA filter.

4. Loosen the screws at the sides and top of the supply duct/shelf supports on the right side of the chamber. Pull out the duct/shelf support and set it aside.
5. Remove the brass nuts and washers from the rods that are holding the filter frame in place. These nuts will be reused to hold the filter in place.
6. Remove and discard the conduit spacers from the rods behind the filter frame. Place the filter in the oven with the seal side towards the right side oven wall. Reinstall the filter frame using the nuts removed earlier. Make sure the filter face is tight against the inside perimeter of the frame on all sides.
7. Reinstall the brass nuts and washers to tighten the filter frame down. Tighten the six nuts alternately for even tightness. Be careful not to over tighten. Correct installation torque is 28 +/- 3 in-lbs. Be sure to compress the gasket evenly and equally at all points with the filter frame completely covering the opening.
8. Reinstall the shelf support/duct assembly using the screws removed earlier.
9. Reinstall the oven shelf.

HEPA Filter Burn-off

The burn-off process will take place in any piece of equipment where a new HEPA filter is used at temperatures above 180°C / 356°F. There will be smoke, possibly a pungent odor, and a light residue on interior surfaces. This is the result of oxidation of the binder. Most of the binder will leave the filter after running at a temperature of 260°C/500°F for 48 (forty-eight) hours. Check the oven for particles or the exhaust for smoke and odor to determine that the process is finished.

Select a location for this process where the smoke and odor generated will be ventilated with the least amount of interruption and inconvenience. Ideally this will be in the final location for the oven. However, it may be a receiving dock, some well ventilated space or even outside if the weather is acceptable. If this location is a very clean area, then special attention must be given to an exhaust hook-up that will capture the smoke and odor. The post-cleaning (i.e. oven wipe down) may also generate dust, and care should be taken if this is done in a clean room.

The following procedure is recommended:

1. Locate the equipment exhaust opening where chamber air is being expelled.

If the oven filter is burned off in a clean area, be sure to handle the equipment exhaust appropriately. If the equipment is large and the exhaust stack is a permanent service connection, it should be connected before the burn-off process is run. If the equipment is small with no permanent exhaust duct required, arrange a temporary connection out of the clean area that will handle the maximum temperature of the equipment. Direct the smoke and odor outside, or to a highly ventilated area.

2. Set the temperature control at the maximum process temperature.
 - Silicone: Ramp at 1.25°C/min to 260°C and soak for 48 hours.
 - Media Pack: Ramp at 1.25°C/min to 260°C and soak for 48 hours.
 - Termikfil: Ramp at 5°C/min to 350°C and soak for 48 hours.
3. Start the fan after making the electrical power connections.
4. Energize the equipment heater.

Use enough fresh air to remove the smoke, while still being able to achieve and maintain the necessary temperature. The completion of the burn-off period should be based on the particle level in the oven or smoke-free exhaust and minimal odor level.

The filter hold-down nuts should be checked after burn-off and tightened again if necessary. For best oven particle control, this step should be repeated on a regular basis.

NOTE: If it is necessary to move the equipment after the burn-off process, considerable care should be used. The binder which gives strength to new filters is now burned-off and the media is very fragile. Rough handling of either the filter alone or the equipment with the filter installed is not recommended as it may tear the media and lead to reduced filter efficiency. Removal of the filter after heating can also result in damage to the frame seal, and is only recommended when replacing the filter.

Filter High Limit

The LCC/D2-14*-3 series ovens have been equipped with a redundant high limit device to protect the HEPA filter. The sensor for the high limit is located before the air inlet of the HEPA filter. The high limit device is located in the lower compartment of the oven. If the oven temperature exceeds the factory set Filter High Limit temperature, the high limit will trip, shutting down the heater and protecting the HEPA filter.

Before resetting the high limit, determine the cause of the excessive temperature. Under normal operating conditions the Filter High Limit should never trip. If the high limit trips, it must be reset by removing the access panel to the lower compartment. The high limit is located next to the transformer; press the reset button on the high limit. See the MIC1162 reference manual for the operation of this high limit.

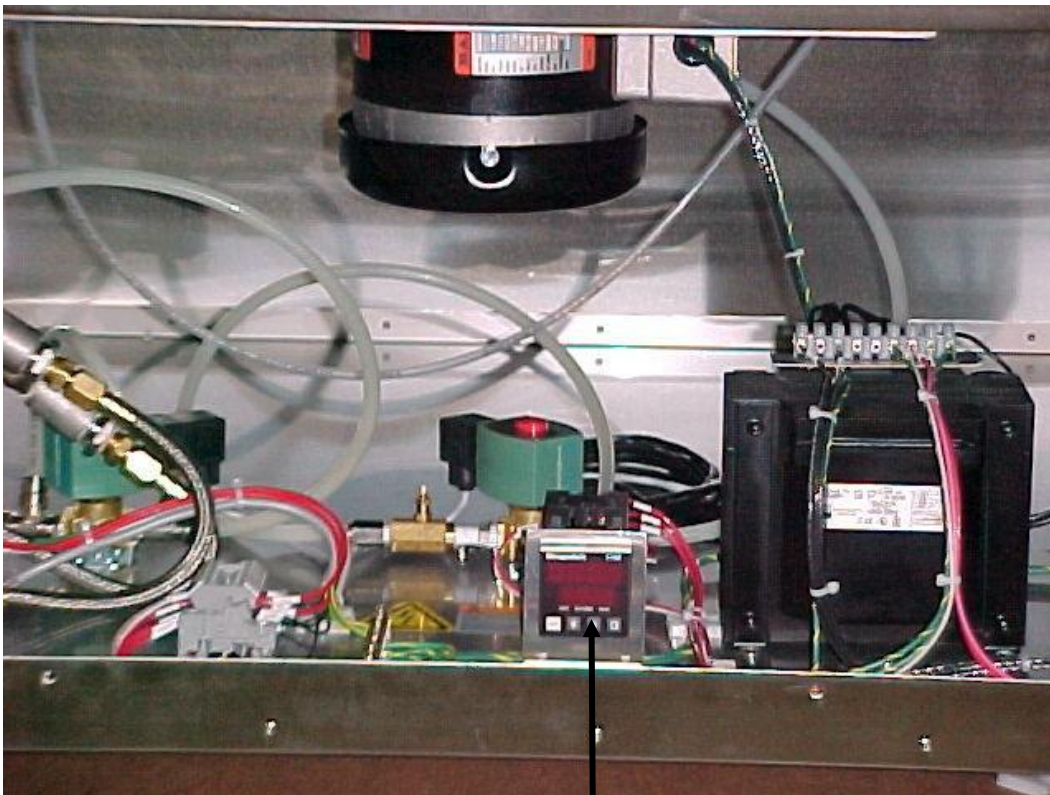

LCC2-14 HEPA High Limit

OVEN OPERATION

Oven

The LCC/LCD2-14PT-3 Series pass-through oven is a class 100 clean room oven with HEPA (High Efficiency Particulate Air) filtration. This oven is ideal for processes where minimization of contamination is essential.

Forced convected airflow provides rapid uniform distribution of heat. A HEPA (High Efficiency Particulate Air) filter is mounted in a stainless steel frame in the supply plenum. These filters are 99.97% effective in filtering 0.3 micron particles prior to filter burn-off.

The cooling/exhaust fan is controlled on/off by an event relay in the Protocol Plus Control. The cooling fan is used for rapid cool-down at the end of the process cycle, or to maintain low temperature setpoints during process cycle. It may also be turned on at the start of a process cycle to assure that starting temperature is less than 70°C.

The oven has a type 304-2B stainless steel interior. All interior seams are continuously welded on the insulation side. This protects the work chamber from contaminated air and permits chamber washing without damaging the insulation. Interior ductwork may be easily removed for cleaning. Heater frame, fan wheel and motor shaft are constructed of stainless steel.

Non-sterile side controls are mounted on the front of the oven for easy operation and readability. The EMO (emergency off) switch and indicator lights are mounted on the control panel on the sterile side. Two electropolished stainless steel wire shelves are provided. The shelves are removable and adjustable on three inch centers.

System Control

A Despatch Protocol Plus controller/high-limit device is used to control the unit. This is located on the control panel of the oven. See the section on the Protocol Plus controller for detailed operation.

- The Protocol Plus controller provides temperature control for the process.
- The Protocol Plus controller provides outputs for the cooling/exhaust fan, and door lock switch/door release pushbuttons.
- As many as eight (8) profiles for oven heating cycles are stored in the Protocol Plus controller. These are accessed by the operator using the Protocol Plus keypad.
- Indicator lights on the sterile side provides visual indication of the cycle status, as follows:

Red (pilot light) – Non-Sterile Door Open

Yellow (pilot light) – Cycle On

Green (illuminated push button) – Cycle Complete (depress push button after unloading and sterile door closed)



Indicator Lights

- Optional MODBUS RS422/485 serial communications hardware may be installed on the Protocol Plus controller, with two 9-pin communications ports located on the front of the oven. This provides the ability to network the oven(s) with a host PC.

- The optional three-color beacon light on the non-sterile side provides visual indication of the cycle status, as follows:
 - Green** – Cycle in process
 - Yellow** – Standby. Operator has unloaded product. Oven waiting for next cycle.
 - Red** – Error or fault condition.
- The optional High-Limit Alarm indicates when the high-limit setpoint has been exceeded. An illuminated Alarm Silence push-button lets the operator turn off the alarm while providing a red warning light until the high-limit condition is corrected.

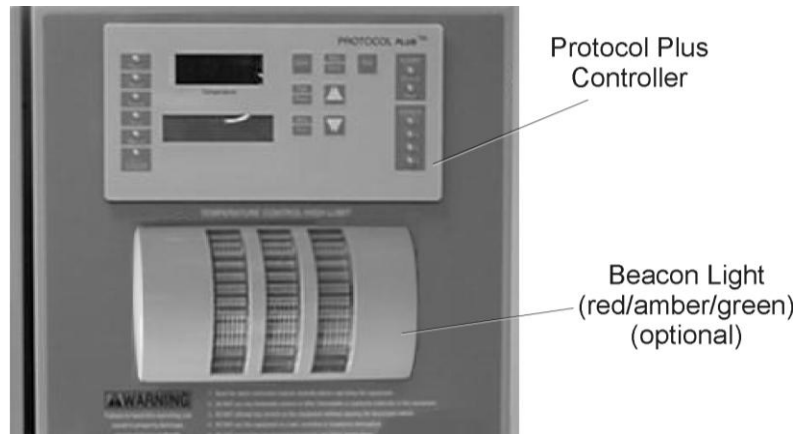

Upper Portion of Control Panel (optional beacon light installed)

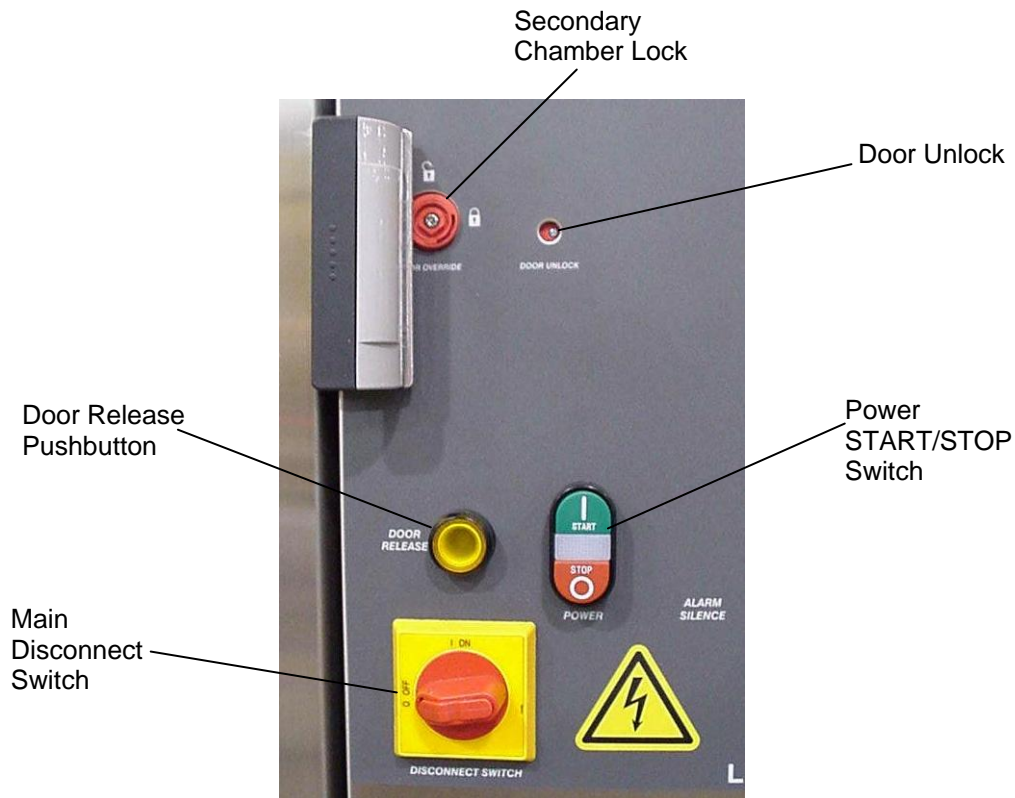

Lower Portion of Control Panel (Need New)

Manual Unlock: In the event of power failure, a hollow-point torx tip tool (provided) may be inserted and rotated 90 degrees counterclockwise to allow the chamber door to open. It must be turned back to the locked position to allow electrical operation again.

Main Disconnect Switch: This disconnect switch is connected to the load break switch behind the panel that disconnects or connects power from the main line.

HEPA Filters

HEPA (High Efficiency Particulate Air) filters are used to limit particulate size in the work chamber to 0.3 microns or less.

NOTE: Chamber temperature transitions must not exceed 1.25°C/minute in order to maintain class 100 chamber conditions. An optional filter is available for transition rates up to 5°C/minute. Consult factory.

Definitions

HEPA - High Efficiency Particulate Air

Burn-Off - A process for getting rid of the binder contained in the filter.

D.O.P. - Dioctyl Phthalate - Aerosol particles of submicron size used in the testing phase to spot defects or measure filter efficiency. Despatch Industries DOES NOT RECOMMEND use of this or other organic challenge agents.

Binder - An organic substance that is used in the construction of the filter that gives some structural strength to the media.

Filter Packaging and Shipping

Packaging practice varies among the filter unit manufacturers. Normally units are packaged in cardboard cartons with various approaches for internal strengthening and impact-resistance of the container. The shipping carton normally is marked with a vertical arrow and "This Side Up". A filter unit is placed in the carton so that the pleated folds are vertical (running from top to bottom - not side to side).

Filters should be shipped, handled and stored with the pleats in the vertical position. If shipped with the pleats in the horizontal position, the filter medium may break at the adhesive line. If handled or stored with the pleats in the horizontal position the pleats may sag.

Moreover, the filter unit should be installed with the pleats in the vertical position. When installed in the horizontal position the pleats form shelves for the collection of entrapped material. The accumulated weight of this material causes sagging and leads to an early failure of the unit.

Handling

The filter is shipped in the original carton or package that the filter manufacturer uses. This will give good storage and maximum protection from dirt and moisture.

HEPA filters should be stored and moved in the shipping carton with in the upright position. Handling should be kept to a minimum. During installation the filter should be removed from the shipping carton and installed directly into the oven.

If for any reason an unpackaged filter unit must be placed with its face on the floor or other surface, the surface must be cleared of every object or irregularity, which might damage the filter pack.

HEPA Filter Validation Testing

This section describes the Despatch position and recommendations for HEPA filter testing and oven validation procedures. Despatch guarantees that the filters will meet specified efficiency ratings when the filter is:

- properly installed
- run at or below 180°C, at a constant temperature
- burned off at 260°C for 48 hours before running

D.O.P. Testing

In D.O.P. testing, aerosol particles of submicron size are used to spot defects or measure filter efficiency. Degenerative by-products of this test are distributed throughout the oven chamber upon heat-up. These and other organic challenge agents also present a fire hazard for this non-Class A (NFPA 86) oven. Therefore Despatch does not recommend D.O.P. filter testing.

Class 100 Testing

Despatch guarantees the environment within the oven to be Class 100. This classification is based upon measurement of the particulate level within the oven work chamber.

Class 100 testing may be performed before or after a proper filter burn-off procedure has been performed. Despatch will guarantee Class 100 conditions measurements based on the direct method of test employing an extraction-type particulate analyzer. An indirect method of testing involves particle settling over a specified period of time onto a clean disk. Please consult the factory for expected levels.

Validation Testing

Based on the issues discussed in this section, Despatch recommends the following test sequence for pharmaceutical Class 100 ovens.

1. Proper installation of the HEPA filters.
2. Ambient air challenge to determine integrity of oven chamber and filter gaskets.
3. Proper filter burn-off procedure.
4. Class 100 testing inside the work chamber.

The Necessity of the Burn-off Process

HEPA filters contain a binder material, which protects the filter media during production and shipping. This smoke is typically not desirable during normal operation of the oven. Burning off the binder will ensure a clean process at elevated temperatures.

When the binder is burned off of the filter media, the filter becomes very fragile, too fragile to withstand normal shipping and handling. For this reason, Despatch does not perform the burn-off procedure. The burn-off process is not necessary at process temperatures consistently under 180°C.

Filter Unit Replacement

Replacement of the filter unit is necessary for these reasons:

- Resistance, or pressure drop, across the filter unit. Maximum level of resistance in inches (water gauge) will vary depending upon the operation of the filter and the available fan capacity. Adequate fan capacity must be available.
- Loss of efficiency (leakage), determined from air-sampling measurements made downstream of the filter unit.
- Visible damage or rupture of the filter media in a unit.
- Change in process application.
- Excessive build-up of lint or combustible particulate matter on the filter unit.
- Water droplets in airstream through filter, free water (RH = 100%), will saturate filter very quickly and may cause burnout or holes in burned off filter media.

HEPA Filter / Magnehelic Pressure Gauge

The LCC Series oven is equipped with a Magnehelic pressure gauge which measures the pressure in front of the HEPA filter. As the filter becomes dirty, the pressure will increase. Despatch recommends changing the filter when the pressure is 1" w.c. greater than when the filter was first installed.

Since the pressure can be affected by many factors involved in the installation, it is important to record the pressure of a new filter, so that the pressure readings can be periodically checked against this baseline. The table below is provided for recording this information.

HEPA Filter Preventative Maintenance Table

A	B	C	D
Date	Comments	Pressure (inches of water)	Oven Temperature
	Typical Values	2-3 inches	60°C
	Filter first installed.		

OPERATING

Users and operators of this oven must comply with operating procedures and training of operating personnel as required by the Occupational Safety and Health Act (OSHA) of 1970, Section 5 and relevant safety standards, and other safety rules and regulations of state and local governments. Refer to the relevant OSHA and National Fire Protection Association (NFPA) safety standards.

Loading the Oven

Despatch Industries cannot be responsible for either the process or process temperature used, or for the quality of the product being processed. It is the responsibility of the purchaser and operator to see that the product undergoing processing in a Despatch oven is adequately protected from damage.

Carefully following the instructions in this manual will help the purchaser and operator in fulfilling that responsibility.

When loading the oven avoid spills of anything onto the heater elements or onto the floor of the oven. Do not place the load on the oven floor plate. This may cause the load to heat unevenly and the weight may cause shorting out of the heater elements. Use the shelves provided.

WARNING: Do not use any flammable solvent or other flammable material in this oven. Do not process closed containers of any substance or liquid in this oven because they may explode under heat.

The two shelves are designed to be pulled out about halfway without tipping. Do not overload the shelves.

Distribute the workload evenly so that airflow is not restricted. Do not overfill your oven. The workload should not take up more than two-thirds of any dimension of the inside cavity.

Pre-Startup Checklist

- Know the system. Read this manual carefully. Make use of its instructions and explanations. The know how of safe, continuous, satisfactory, trouble-free operation depends primarily on the degree of your understanding of the system and of your willingness to keep all parts in proper operating condition.
- Check line voltage. This must correspond to nameplate requirements of motors and controls. A wrong voltage can result in serious damage. Refer to the section on power connections in the INTRODUCTION of this manual.
- Check fresh air and exhaust dampers. Do not be careless about restrictions in and around the fresh air and exhaust openings and stacks. Under no condition, permit them to become so filled with dirt that they reduce airflow.

WARNING: Do not use any flammable solvent or other flammable material in this oven. Do not process closed containers of any substance or liquid in this oven because they may explode under heat.

Operating Procedure

Starting the Oven

1. Turn the yellow/red DISCONNECT SWITCH to ON.
2. Press the POWER pushbutton ON switch.
 - The green CYCLE COMPLETE illuminated push button will be lit (sterile side). If required, the sterile door may be opened (non-sterile door will be locked); otherwise, depress the CYCLE COMPLETE illuminated push button. This will reset the oven, indicating oven is ready for new process.
 - To open the oven door, press the STERILE DOOR UNLOCK pushbutton and at the same time, press on the door. The oven door will unlatch and open.
 - (optional beacon light-equipped units) The amber (center) beacon light will illuminate, indicating that the oven is waiting for new process to start.
3. The non-sterile DOOR RELEASE pushbutton will illuminate. This means the door can be opened (sterile door will be locked).
 - (optional beacon light-equipped units) The amber (center) beacon light will illuminate, indicating that the oven is ready to receive work to be processed.
4. To open the oven door, press the DOOR RELEASE pushbutton and at the same time, press on the door. The LED on the door lock switch will illuminate, indicating the solenoid has been energized. The oven door will unlatch and open.
5. **NOTE:** During the process cycle, both doors will remain locked. The door lock switches has manual override for authorized maintenance personnel to release door in case of power failure.
6. If the oven needs to be shut down in an emergency:
 - From the non-sterile side, turn the disconnect switch to OFF. Reset by turning the disconnect switch back to ON. Go to step two (2) for restarting oven.
 - From the sterile side, push the EMO switch in. Reset by pulling switch out. Go to step two (2) for restarting oven.

Sequence of Operation (system using Beacon Light)

This section describes operation of the oven with the optional beacon light feature.

1. After the system is powered up (see above procedure), the Protocol Plus controller is initialized.
 2. At this point the oven is idle, empty, door closed, and waiting for the next lot to be processed. The Protocol Plus is not running a profile. The amber beacon light is on steady for steps 2 through 5, until profile is started. Refer to the Protocol Plus instructions in this manual.
 3. Open the oven door. The red pilot light on the sterile side (STERILE DOOR OPEN) is on.
 4. Place the product on the shelf in the oven. Close the oven door. Red pilot light on sterile side is off.
 5. Run the desired profile from the Protocol Plus controller.
 - Press the Select key until Profile is displayed (you can press the Run key at any time to activate Profile Mode).
 - Press the ▲▼ key to display the desired profile to run.
 - To start Profile Mode, press the Run key.
- NOTE: The display will change from Stop to Run and the segment time remaining, along with the current segment number, will be displayed.
6. The oven profile cycle is in process and both doors are LOCKED. The yellow pilot light on the sterile side (CYCLE ON) is on. The green beacon light is on steady, the amber beacon light is off.
 7. When the process is complete, the green illuminated push button on the sterile side (CYCLE COMPLETE) is on, and the amber beacon is on.
 8. Press the STERILE DOOR UNLOCK pushbutton on the sterile side, and open the oven door to remove the product workload.
 9. The operator closes oven door and presses the green illuminated push button (CYCLE COMPLETE) to complete the process cycle.
 10. The yellow pilot light on the non-sterile side (DOOR RELEASE) is on, and the amber beacon is on. The oven is ready for the next lot.

High Limit Alarm with Alarm Silence

This option provides an audible and visual alarm when the temperature exceeds the high limit setpoint on the control. The alarm horn is located on the right side of the control panel door. On the front of the control panel door, there is an illuminated (red) momentary push button switch to silence the alarm horn.

When the chamber temperature exceeds the high limit setting on the control, the heater will shut down the Alarm Horn will sound and the red push button will illuminate. To silence the alarm:

1. Depress the Alarm Silence push button.
 - The Alarm Horn will be silenced, but the red pilot light on the push button will remain illuminated.
 - (optional beacon light-equipped units) The red (top) beacon light will illuminate, indicating a fault has occurred.
2. When the high limit condition clears, press reset on the control. See the section on the Protocol Plus controller for detailed operation.
3. The heater should be back on and the control should be functioning correctly. The red pilot light will not be illuminated.
4. If the high limit trips repeatedly, identify the cause and correct the problem.

Maintenance

Do not attempt any service on this oven before opening the main power disconnect switch.

WARNING:
Disconnect the main power switch or power cord before attempting any repair or adjustment.

Checklist

- Keep equipment clean. Gradual dirt accumulation retards airflow. A dirty oven can result in unsatisfactory operation such as unbalanced temperature in the work chamber, reduced heating capacity, reduced production, overheated components, etc. Keep the walls, floor and ceiling of the oven work chamber free of dirt and dust. Floating dust or accumulated dirt may produce unsatisfactory work results. Keep all equipment accessible. Do not permit other materials to be stored or piled against it.
- Protect controls against excessive heat. This is particularly true of controls, motors or other equipment containing electronic components. Temperatures greater than 50°C (122°F) should be avoided.
- Establish maintenance & checkup schedules. Do this promptly and follow the schedules faithfully. Careful operation and maintenance will be more than paid for in continuous, safe and economical operation.
- Maintain equipment in good repair. Make repairs immediately. Delays may be costly in added expense for labor and materials and in prolonged shut down.
- Practice safety. Make it a prime policy to know what you are doing before you do it. Make CAUTION, PATIENCE, and GOOD JUDGMENT the safety watchwords for the operation of your oven.

Lubrication

Fan motor bearings are permanently lubricated. All door latches, hinges, door operating mechanisms, bearing or wear surfaces should be lubricated to ensure easy operation.

PROTOCOL PLUS CONTROL

The special features of the Protocol Plus™ control include:

- PID tuning
- Ramp/Soak programming of up to 64 segments
- Segment looping and profile linking
- Built-in manual reset high limit control
- Built-in process timer
- Dedicated LED display for process temperature
- Multi-purpose two-line LCD display with backlight
- Auto-tuning
- Security access
- Process temperature retransmission signal
- Digital inputs for remote profile control
- Real time clock
- Optional relay outputs for events, alarms, or end-of-cycle signal
- Optional RS232/RS422/RS485 MODBUS communications

Theory of Control Operation

The Protocol Plus is a modular microprocessor based digital temperature controller. The Protocol Plus operates as a dual functioning controller/high limit instrument. The control portion utilizes a time-proportioning voltage signal to control heating devices with minimal temperature fluctuations.

The high limit portion protects the product and/or the oven from overheating. If the product being processed has a critical high temperature limit, the high limit setpoint should be set to a temperature somewhat below the temperature at which the product could be damaged. If the product does not have a critical high temperature limit, the high limit setpoint should be set 5 to 15 degrees higher than the maximum programmed setpoint at which the oven will operate.

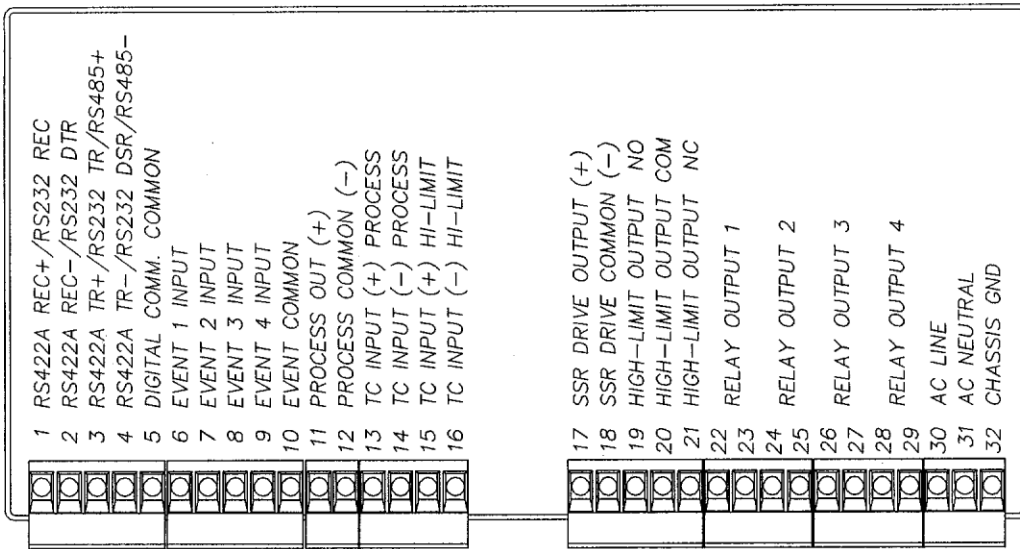
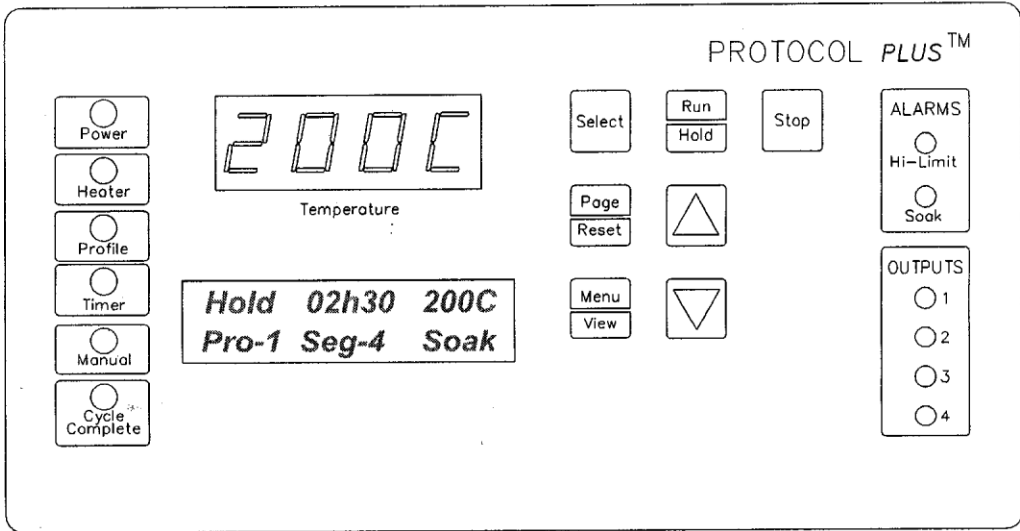

Protocol Plus Faceplate and Wiring Diagram

Operating Modes

The Protocol Plus control has five modes of operation available:

- Stopped Mode:** All control and relay outputs are off. Stopped Mode is integrated into each of the following four modes of operation.
- Manual Mode:** Control operates as a single setpoint control until Stopped mode is accessed
- Timer Mode:** Control operates as a single setpoint control until preset time period has expired.
- Profile Mode:** Control operates as a ramp/soak profiling control until the end of the profile. 8 profiles are available with up to 8 ramp/soak segments in each profile.
- Auto Start Mode:** Control may automatically start Manual, Timer, or Profile mode based on a preset time and day.

The optional event outputs can be utilized during Manual, Timer, or Profile modes.

Setup Mode

The control has a Setup Mode which provides access to control configuration and programming of profiles. The Setup Mode contains ten separate electronic Pages where the configuration and programming parameters (Menu items) are found. The Setup Mode Pages are described in detail elsewhere in this manual.

Fast Start Mode

The Protocol Plus control has the ability to automatically start an operating mode when power is applied. This feature may be useful if the same mode of operation is used everyday. The user can turn on the power and the oven will start the desired process automatically. The Fast Start Mode is controlled by the Power-Up Start parameters on the Control page (see Setup Mode).

High Limit

The control has an integrated high limit function which will disable the heater output when tripped. If the high limit does trip, the relay will need to be manually reset. When the high limit relay is tripped, the Hi-Limit indicator will be lit. Allow the oven to cool several degrees (or increase the high limit setpoint) and then press the Reset key. The indicator will turn off.

High-Limit temperature readout is provided on LCD Line #2 in all Modes (Stop, Run, Hold, and Standby) except Setup Mode. High-Limit temperature is displayed for 10 seconds, alternating with current Mode and Status display for 10 seconds.

The control will not allow the high limit setpoint to be set below the current setpoint value.

Indicators

The Protocol Plus control has 12 indicating LEDs that provide operational information to the user.

- **Power LED:** Indicates that power is supplied to the instrument.
- **Heater LED:** Indicates that the heater output is active.
- **Profile LED:** Indicates that the Profile Mode is in operation.
- **Timer LED:** Indicates that the Timer Mode is in operation.
- **Manual LED:** Indicates that the Manual Mode is in operation.
- **Cycle Complete LED:** Indicates that the control is in Stopped mode.
- **Hi-Limit Alarm LED:** Indicates that the high limit relay has tripped (de-energized).
- **Soak Alarm LED:** Indicates that the guaranteed soak deviation is in alarm condition.
- **Outputs 1 through 4:** Indicate that the optional relay outputs are in the ON state. These outputs may be configured as timed event outputs, process temperature trip point outputs, alarm outputs, or as an end of cycle relay output. The ON state can be configured as energized or de-energized.

Displays

The Protocol Plus control has two displays. A dedicated LED upper display shows the oven temperature. A two-line LCD lower display provides information on control status, high limit temperature, and allows changes to be made to the control settings.

Key Functions

The Protocol Plus control has seven keys that provide operation.

- **Select key:** Press to select mode of operation. In Setup Mode, to select profile number or relay. In Profile/Run Mode, press simultaneously with the UP key to advance a segment.
- **Run/Hold key:** Press to activate a mode of operation. If a Profile (or Timer) Mode is running, pressing the Run/Hold key will place the Profile (or Timer) in Hold status. A subsequent press will resume the Profile (Timer).
- **Stop key:** Press to stop any mode of operation.
- **Page/Reset key:** While in Setup Mode, press to access different Pages of configuration, Press this key to silence an alarm if the instrument alarm sounds during operation. In an operating mode, if an alarm or error condition occurs, press this key to return the instrument to normal operation once the condition is cleared.
- **Menu/View key:** While running any operating mode, pressing this key will display the high limit setpoint. While in Setup Mode, pressing this key will provide access to each Menu parameter.
- **▲▼ keys:** Press these keys to adjust parameter settings. In Profile/Stopped Mode, press to select profile to run. In Profile/Run Mode, press ▲ key simultaneously with the Select key to force the program to advance one segment.

Outputs

The Protocol Plus control has seven different outputs available.

- Heating output:** The control output is a DC voltage open-collector output which is time-proportioned and designed to control a heat control device such as a solid state relay.
- High limit:** The high limit output is a form C relay which is energized under normal operating conditions. If the control senses a temperature higher than the high limit setpoint, or if there is a sensor error, the high limit relay will de-energize until the condition is cleared and the Reset key is pressed. When the high limit relay is de-energized, the heater is disabled.
- Retransmission:** The retransmission output is a DC 1 to 5 volt or 4 to 20 ma (DC) signal that is proportional to the process temperature. The signal can be an input to other devices such as a chart recorder.
- Relay (four optional outputs):** The four form A dry contact relay outputs can be configured to function as alarms, events, or end of cycle. These outputs can be utilized in Manual, Timer, or Profile Mode.

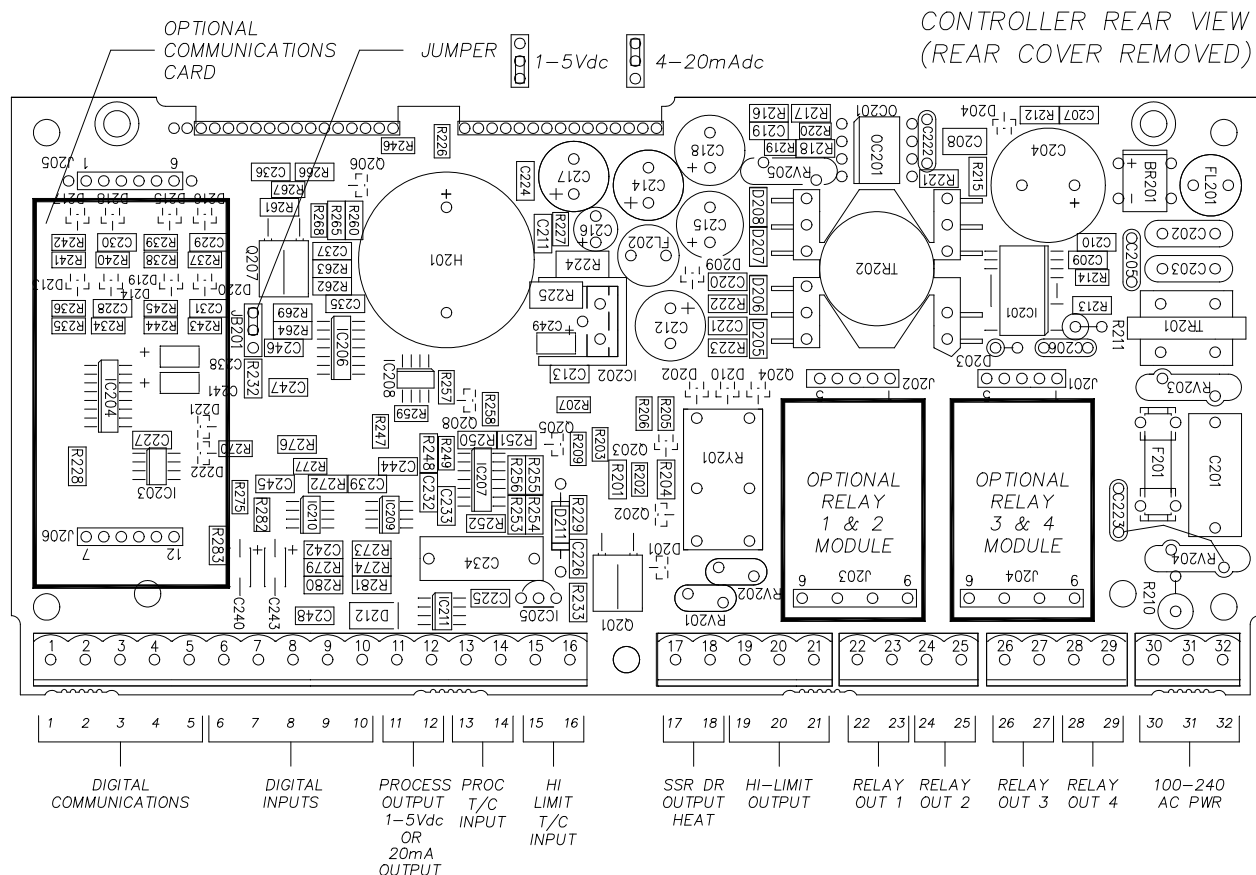

Layout for Optional Components

Relay (Continued)

Use the Relay Card Optional Ay p/n 144562 to add relays to the standard controller. Each relay card contains two relays (maximum of two cards Ay's allowed).

Communication

The Protocol Plus control has optional MODBUS communication available which can communicate via RS232, RS422, or RS485 to a computer. See communications option assembly p/n 161957 for board and cable assembly. Please refer to the MODBUS communications manual which comes with this option.

Optional Software

The Protocol Manager program allows the operator to start/stop multiple ovens (32 maximum) from a personal computer. A data log can also be used to record process information (p.n. 140008).

INSTRUCTIONS

Start-Up

These instructions are provided as a quick reference for operating the Protocol Plus control. If the Profile Mode is to be used, or the configuration of the control needs to be changed, please refer to the Setup Mode instructions before operating the control. For more detailed operating instructions refer to the Operation instructions for the mode you wish to use.

Upon initial power-up the control is in Manual/Stopped Mode (unless the Autostart or Fast Start Modes are active). To activate any operating mode from Stopped Mode, press the Select key until the desired mode is displayed, then press the Run key. If the proper Profile number is not displayed when the Profile Mode is accessed, press the ▲ or ▼ keys until the desired Profile number is displayed, then press the Run key. If no profile numbers can be displayed (display only reads NONE) then no profiles are currently programmed (see Setup Mode).

The Hi-limit thermocouple actual temperature reading is displayed, when the lower LCD display reads **HL Temp**. Note: This is not a error message.

The temperature setpoint can be adjusted while Manual or Timer Mode is running by pressing the UP or DOWN key.

To momentarily hold the Timer or Profile Mode, press the Hold key. To continue the Timer or Profile Mode, press the Run key.

To return to Stopped Mode at any time, press the Stop key and the cycle complete LED will illuminate.

Note that the control can be configured to automatically activate Manual, Timer or Profile Mode when power is applied (power switch turned on). See Control Page in the Setup Mode to utilize the Fast Start mode.

Operation

Manual Mode

Press the Select key until Manual is displayed (note you can press the Run key at any time to activate Manual Mode).

1. Press the Menu key to display the Process Temperature Setpoint (setpt). You can change the Setpoint with the ▲▼ keys.

Note: If the SPChange parameter on the Enable page in Setup Mode has been set to DISABLED, it must be changed to ENABLED before any changes to the process temperature and high limit setpoints can be made.

2. Press the Menu key a second time to display current high limit setpoint (Hi-Lim SP). The value can be adjusted by pressing the ▲▼ keys. If **Band** is displayed, the high limit band feature is activated (see Control page) and the high limit can not be adjusted.
3. (optional feature) Press the Menu key a third time to display Event1. Press the ▲ key to turn on the event or ▼ to turn off the event. Repeat for all events which are enabled (up to 4).
4. To start Manual Mode, press the Run key.

The display will change from Stop to Run. To return to Stopped Mode, press the Stop key. While in operation, the process setpoint can be adjusted by using the ▲▼ keys to change the value while the mode is running. Pressing the Menu key will display the High Limit Setpoint (HLSP) setting.

If changes to the high limit setpoint or event output configuration are needed, they must be done from the stopped mode.

Timer Mode

1. Press the Select key until Timer is displayed (note you can press the Run key at any time to activate Timer Mode).
2. Press the Menu key to display the Process Temperature Setpoint (Setpt). You can change the Setpoint with the ▲▼ keys.

Note that if the SPChange parameter on the Enable page in Setup Mode has been set to DISABLED, it must be changed to ENABLED before any changes to the process temperature and high limit setpoints can be made.

3. Press the Menu key a second time to display current high limit setpoint (Hi-lim SP). The value can be adjusted by pressing the ▲▼ keys. If **Band** is displayed, the high limit band feature is activated (see Control page) and the high limit can not be adjusted.
4. Press the Menu key a third time to display Time Set. You can change the time setting with the ▲▼ keys.
5. (optional feature) Press the Menu key a fourth time to display Event1. Press the ▲ key to turn on the event or ▼ to turn off the event. Repeat for all events which are enabled (up to 4).
6. Press the Menu key a fifth time to display the current guaranteed soak band (TmrGuarSoak) value. If the process temperature deviates from the setpoint by more than this value, the timer is placed in a hold condition. The timer continues when the process temperature falls within range. Reference the Quick Reference and Default Values section for available settings.
7. To start Timer Mode, press the Run key.

The display will change from Stop to Run and the time remaining will be displayed. To return to Stopped Mode, press the Stop key. While in operation, the process setpoint can be adjusted by using the ▲▼ keys to change the value while the mode is running. Pressing the Menu key will display the High Limit Setpoint.

Pressing the Run/Hold key while the Timer Mode is in operation will put the control in Hold status. The Timer LED will flash to indicate the held status. Press the Run/Hold key again to continue timing. The Timer LED will return to lit status.

Profile Mode

1. Press the Select key until Profile is displayed. "None" may be displayed if a profile has not been selected or no profiles entered.
2. Press the ▲▼ key to display the desired profile to run.
3. To start Profile Mode, press the Run key.

The display will change from Stop to Run and the segment time remaining, Temperature Setpoint, Profile #, along with the current segment number, will be displayed. To return to Stopped Mode, press the Stop key.

Pressing the Run/Hold key while the Profile Mode is in operation will put the control in Hold status. Press the Run/Hold key again to continue the mode. The Profile LED will flash to indicate the hold status.

To advance to the next segment while running a profile, press the Select and UP arrow keys at the same time.

If **Link To** is set to **Standby** in the Program Page, at the End of Program/Profile,

1. Cycle Complete LED indication goes ON.
2. Controller beeps if **End of Cycle** beep is enabled.
3. Heater/control output keeps controlling oven temperature at last Soak setpoint.
4. All events programmed (if relay cards installed and programmed as an event) for the last Soak Segment stays active.

Note that ramping down too fast may cause the high limit relay to trip unexpectedly if the high limit band feature is used. This can be avoided by using a separate cooling profile that does not utilize the high limit band and then jumping to that profile to perform rapid cooling.

Auto Start Mode

The Auto Start Mode allows the control to start Manual, Timer, or Profile mode automatically at a preset time and day. See the Auto Start Page in Setup Mode for the time, day, and operating mode settings.

To activate the Auto Start Mode,

1. On Auto Start page, **Enable** is set to **Yes**.
2. LCD reads **Active** on line 1 in Auto Start Mode.
3. On Auto Start page **Enable** set to **No**, will deactivate Auto Start Mode.

Note that once you activate Auto Start, you can continue to use all operating modes as normal. If an operating mode is running at the time of a preset Auto Start function, and Auto Start is activated, the existing operating mode will override the auto Start function and the Auto Start will not turn on.

Note: All process Set to Run in Auto Start Mode must be at least one minute long for all Run Modes (Manual, Timer, and Profile).

Setup Mode

Configuration of the control and programming of the ramp/soak profiles must be done in the Setup Mode. To access Setup Mode, the control must first be in Stopped Mode.

1. Press the Select key until Setup is displayed.
2. Press the Page key and Security will be displayed.
3. Press the Menu key and Password will also be displayed. Use the ▲▼ keys to enter the proper password.
4. Once the proper password is displayed, press the Page key twice to enter the Setup Mode.

To exit Setup Mode, press and hold the Page key for three seconds.

The control has two levels of password-protected security. Level one provides access only to those menu pages that are enabled on the Enable page. Level two provides access to all menu pages, including the Enable page. The default security password values are 1 for level one and 2 for level two.

If an improper password has been entered, the control will remain at the Security display. To enter the proper password, press the Menu key. To exit Setup Mode, press and hold the Page key for three seconds.

Mapping of the Setup Mode is provided in the following sections. To access each parameter Page, which are described in detail in the following sections, press the Page key until the desired page heading is displayed. Press the Menu key to access each Menu parameter. Press the ▲▼ keys to change Menu parameter settings.

Refer to the Quick Reference and Default Values section for available settings for each Menu parameter.

Press the Page key to continue with each Page, or press and hold the Page key for three seconds to exit Setup Mode.

Instructions for Setup Mode Pages

Program Page

Programming of the profiles is provided on the Program Page. Eight profiles are available with up to eight ramp and soak segments per profile.

If the optional relay outputs are installed, they must be configured as alarms or events on the Relay Outputs Page before they can be utilized. If configured as event outputs, these relays can be used as time or temperature events.

When entering the Program Page, press the Select key to select the profile you wish to enter/edit, then press the Menu key. The first parameter (Profile #, Segment 1, Ramp Time) will display. Adjust the time value with the ▲▼ keys. Once the proper value is displayed, press the Menu key to continue. Continue with the Menu key to adjust/view each parameter.

If the ramp time value of the current segment is left at 0:00, the next press of the Menu key will advance the control to the High Limit Setpoint parameter for that profile. Continue entering / verifying all parameters until you get to the last parameter (Guaranteed Soak Band). Once all parameters have been properly entered, press the Page key to return to the top of the Profile Page. You can press the Select key to enter/edit another profile, press the Page key to access another page, or press and hold the Page key to exit Setup mode.

While editing any profile, pressing the Select key will advance the control to the time value for the next segment, until the last segment has been reached. This allows faster editing of the profile rather than pressing the Menu key to advance past each parameter.

If **Link To** is set to **Standby** in the Program Page, at the End of Program/Profile,

1. Cycle Complete LED indication goes ON.
2. Controller beeps if **End of Cycle** beep is enabled.
3. Heater/control output keeps controlling oven temperature at last Soak setpoint.
4. All events programmed (if relay cards installed and programmed as an event) for the last Soak Segment stays active.

To run a profile indefinitely, link the profile to itself.

Menu Item	Display	Description
Ramp Time Seg 1	Pro-1 Seg-1 Ramp Time	Ramp time for segment 1 of profile
Event 1 Set Value*	Pro-1 Seg-1 Ramp Event 1	Event 1 setting for segment 1 ramp of profile
Event 2 Set Value*	Pro-1 Seg-1 Ramp Event 2	Event 2 setting for segment 1 ramp of profile
Event 3 Set Value*	Pro-1 Seg-1 Ramp Event 3	Event 3 setting for segment 1 ramp of profile
Event 4 Set Value*	Pro-1 Seg-1 Ramp Event 4	Event 4 setting for segment 1 ramp of profile
Soak Temp Seg 1	Pro-1 Seg 1 Soak Temp	Soak temperature for segment 1 of profile
Soak Time Seg 1	Pro-1 Seg 1 Soak Time	Soak time for segment 1 of profile
Event 1 Set Value*	Pro-1 Seg-1 Soak Event 1	Event 1 setting for segment 1 soak of profile
Event 2 Set Value*	Pro-1 Seg-1 Soak Event 2	Event 2 setting for segment 1 soak of profile
Event 3 Set Value*	Pro-1 Seg-1 Soak Event 3	Event 3 setting for segment 1 soak of profile
Event 4 Set Value*	Pro-1 Seg-1 Soak Event 4	Event 4 setting for segment 1 soak of profile
(repeat for segments 2-8, until ramp or soak time = 00:00)		
High Limit Setpoint	Pro-1 Hi-Lim SP	High limit setpoint for profile**
Loop From	Pro-1 Loop From Seg	To start a loop action in a profile
Loop To	Pro-1 Loop To Seg	To end a loop action in a profile
Loop Count	Pro-1 Loop Number	Number of times to execute loop
Profile Link	Pro-1 Link To Pro	To jump from this profile to another
Guaranteed Soak	Pro-1 Guar Band	Guaranteed soak band for profile

See the definitions on the following pages for parameter ranges.

* only available if optional relay outputs are installed (repeat all for profiles 2-8)

** Set to **Band** to use the high limit band feature

Profile #	There are eight profiles available.
Segment#	Recipe segments 1 through 8 may be programmed, each with its own set of events, ramp and soak times, and soak temperature.
Ramp Time	The time required to ramp from one setpoint up to another setpoint. Values between 0 and 99:59 are allowable. In the Protocol Plus controller, the profile ramp and soak times are stored without units. Units are set as either hours and minutes (HH:MM) or minutes and seconds (MM:SS). The setpoint will automatically increment from the actual temperature to the soak temperature.
EV1 through 4	From 1 to 4 events may be programmed into the ramp time portion of each segment here. These typically involve actuating/disabling relays to close/open valves or perform other relay-controlled functions. NOTE: These will only actuate when the controller has the relay cards installed and programmed for an event.
Soak Temp.	The temperature setpoint of a particular segment is entered here; it can range from -18 to 540 degrees C (0 to 1000 degrees F).
Soak Time	The duration of soak is entered here; the value can range from 0 to 99:59.
EV1 through 4	From 1 to 4 events may be programmed into the soak portion of each segment here. These typically involve actuating/disabling relays to close/open valves or perform other relay-controlled functions. NOTE: These will only actuate when the controller has the relay cards installed and programmed for an event.
Hi Limit SP	The high limit setpoint may be entered here; if the temperature exceeds this value, the hi-limit will alarm and shut off the heater.
Loop From	Values are No, Seg-1 to Seg-8.
Loop To	Values are No, Seg-1 to Seg-8.
Loop Number	Values are 0 - 99. These values enable the operator to jump from a certain step to another step of the recipe a preset number of times.
Profile Link	Values are STANDBY/STOP/HOLD/1 - 8. When the profile ends, the profile can hold the temperature setpoint while keeping the events active, turn the heater off, hold the temperature setpoint at the end of the profile, or jump to another specified profile.
Guaranteed Soak Band	If the process temperature deviates from the setpoint by more than this value, the soak timer is placed in a hold condition. The timer continues when the process temperature falls within range.

Sample Profile

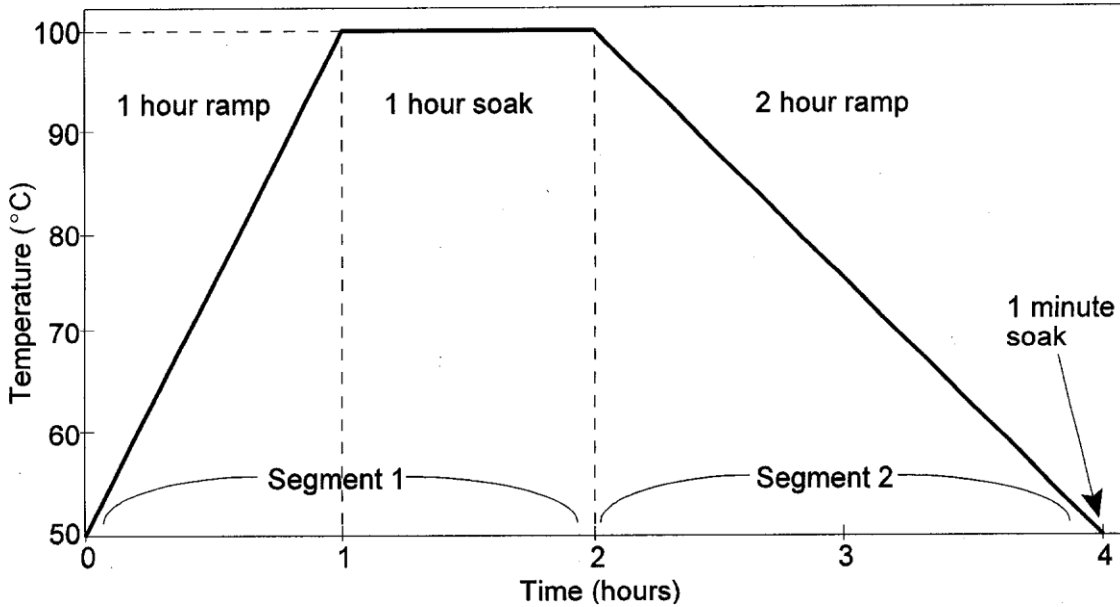

Programming Table

Profile Number 1

Profile Name _____

Segment	Time	Ramp				Temperature	Time	Soak			
		Events						Events			
		1	2	3	4			1	2	3	4
1	01h00					100	01h00				
2	02h00					50	00h01				
3	00h00										
4											
5											
6											
7											
8											
High Limit Setpoint				115							
Loop From Seg				No							
Loop To Seg				No							
Loop Number				0							
Link To Pro				No							
Guar Soak Band				10							

Auto Start Page

The Auto Start Page can be configured to automatically start Manual, Timer or Profile Mode at a specified time and day. Note that if Auto Start Enable is set to Yes in the Setup Mode, the Auto Start feature is not turned on - it is available to the operator to be activated in Stopped Mode.

To configure the Auto Start feature:

1. Access the Setup Mode.
2. Press the Page key until Auto Start is displayed.
3. Press the Menu key. If there is no change in the display, the controller may not have the realtime clock option.
4. Set Auto Start Enable to Yes.
5. Using the Menu key, scroll through the options available and use the ▲▼ keys to set the mode desired for each day of the week. You may select from Manual, Timer, or Profile 1 through 8.
6. When the mode is set press the Menu key.
7. Enter the time of day you wish the mode to activate.
8. Continue through the rest of the week by pressing the Menu key, or press the Page key when done.

One Auto Start mode can be set for each day of the week. Exit the Setup mode by pressing and holding the Page key for three seconds. Press the Select key until Auto Start is displayed. Make sure the correct time and day is displayed. If not proper, set it to the correct time on the Real Time Clock Page in the Setup mode.

To activate the Auto Start Mode,

1. On Auto Start page, **Enable** is set to **Yes**.
2. LCD reads **Active** on Line 1 in Auto Start Mode.
3. On Auto Start page **Enable** set to **No**, will deactivate Auto Start Mode.

Note that once you activate Auto Start, you can continue to use all operating modes as normal. If an operating mode is running at the time of a preset Auto Start function, and Auto Start is activated, the existing operating mode will override the Auto Start function and the Auto Start will not turn on.

Note: All process Set to Run in Auto Start Mode must be at least one minute long for all Run Modes (Manual, Timer, and Profile).

Menu Item	Display	Description	Range
Enable Autostart	Auto Start Enable	Enable (yes) or disable (no) the Autostart function	No, Yes
Sunday mode	Auto Start Sun Mode	Set mode on Sunday to activate	Off, Manual, Timer, Pro-1 to Pro-8
Sunday time	Auto Start Sun Time	Set time on Sunday for mode to activate	00:00 to 23:59
Monday mode	Auto Start Mon Mode	Set mode on Monday to activate	Off, Manual, Timer, Pro-1 to Pro-8
Monday time	Auto Start Mon Time	Set time on Monday for mode to activate	00:00 to 23:59
Tuesday mode	Auto Start Tue Mode	Set mode on Tuesday to activate	Off, Manual, Timer, Pro-1 to Pro-8
Tuesday time	Auto Start Tue Time	Set time on Tuesday for mode to activate	00:00 to 23:59
Wednesday mode	Auto Start Wed Mode	Set mode on Wednesday to activate	Off, Manual, Timer, Pro-1 to Pro-8
Wednesday time	Auto Start Wed Time	Set time on Wednesday for mode to activate	00:00 to 23:59
Thursday mode	Auto Start Thu Mode	Set mode on Thursday to activate	Off, Manual, Timer, Pro-1 to Pro-8
Thursday time	Auto Start Thu Time	Set time on Thursday for mode to activate	00:00 to 23:59
Friday mode	Auto Start Fri Mode	Set mode on Friday to activate	Off, Manual, Timer, Pro-1 to Pro-8
Friday time	Auto Start Fri Time	Set time on Friday for mode to activate	00:00 to 23:59
Saturday mode	Auto Start Sat Mode	Set mode on Saturday to activate	Off, Manual, Timer, Pro-1 to Pro-8
Saturday time	Auto Start Sat Time	Set time on Saturday for mode to activate	00:00 to 23:59

PID Page

The PID Page contains parameters which control the response to the setpoint and process variable input. To access the PID Page, enter the Setup Mode. Press the Page key until PID is displayed. Press the Menu key. Each parameter can be changed by pressing the Menu key until the desired parameter is displayed, and then pressing the ▲▼ keys to change the value.

Menu Item	Display	Description	Range
Display units	PID Temp Unit	Set display units to °C or °F	°C or °F
Proportional band	PID Prop Band	Set proportional band for tuning	1 to 56°C (1 to 100°F)
Integral reset	PID Reset/Rep/Min	Set integral reset for tuning	0.0 to 100 seconds/repeat
Derivative Rate	PID Rate In Sec	Set derivative rate for tuning	0.0 to 500 seconds
AutoTune	PID AutoTune	Enable auto tuning function	Disable, Enable

The AutoTune parameter disables or enables the AutoTune function. To utilize AutoTuning:

1. Access the Setup Mode.
2. Press the Page key until the display reads AutoTune. Press the ▲ key to enable the AutoTune.
3. Press the Page key for three seconds to exit Setup Mode.
4. Cycle power to the instrument.
5. Set Manual Mode to run. The display will alternately display AutoTune and Manual.

If the Manual Mode setpoint is less than 50 degrees higher than the actual process temperature, the AutoTune function will create an error condition. This can be cleared by either cooling off the process temperature or increasing the setpoint until there is more than 50 degrees between them. Once the AutoTune function is allowed to complete tuning, the AutoTune parameter will disable by itself.

If you wish to cancel the AutoTune function, press the STOP key, access the PID page in Setup Mode, and set the AutoTune parameter to Disable.

Control Page

The Control Page contains various parameters which control miscellaneous functions. To access the Control Page, enter the Setup Mode. Press the Page key until Control is displayed. Press the Menu key. Each parameter can be changed by pressing the Menu key until the desired parameter is displayed, and then pressing the ▲▼ keys to change the value.

Menu Item	Display	Description	Range
Cycle Time	Control Cycle Time Sec	Set cycle time in seconds for control output	1 to 60 seconds
High limit setpoint	Control Hi-Lim SP***	Maximum value for all high limit setpoints	MinHiLimSP - MaxHiLimSP*
High limit band	Control Hi-Lim Band	If=0, high limit setpoint= Control Hi-Lim SP If>0, high limit setpoint= Control SP* + Band	Off, 3°C to 11°C (5°F to 20°F)
Power fail recovery	Control PwrFRec	Controls response to loss of power	Stop, Restart, Hold, Resume
Recovery time limit	Control PFRTIME	Control aborts to Stopped mode if power is lost for time period longer then set value	00m00s to 99m59s
Powerup start enable	ControlPwrUpStrt	Allows mode to automatically start when power is first applied	Disable, Enable
Powerup Start Mode	Control StrtMode	Operating mode for powerup start	Off, Manual, Timer, Pro-1 to Pro-8
Hysteresis	Control Hysteresis	Hysteresis for all alarms and temperature events	1°C to 56°C (1°F to 100°F)
Process out low	Control RetOutLo	Process value for retransmit output = 1VDC	-73°C to 760°C (-100°F to 1400°F)
Process out high	Control RetOutHi	Process value for retransmit output = 5VDC	-73°C to 760°C (-100°F to 1400°F)
Time scale	Control TimeScale	Time scale setting for program and timer mode**	hh:mm or mm:ss
Key press beep	Control KeyBeep	Internal beeper sounds when key is pressed	On or Off
End of cycle beep	Control EOBeep	Internal beeper sounds at end of cycle	On or Off
Alarm beep	Control AlarmBeep	Internal beeper sounds for alarms	On or Off

* includes ramping setpoints during profiles and controlled ramps

** power fail recovery time limit is always MM:SS regardless of time scale setting

*** high limit setpoint is a read-only item which is calculated on Enable page

Communication Page (optional)

The Communication Page contains parameters for the communications feature. To access the Communications Page, enter the Setup Mode (see description earlier in this manual). Press the Page key until Communication is displayed. Press the Menu key. (NOTE: If there is no change in the display, the controller does not have the communications board installed.) Each parameter can be changed by pressing the Menu key until the desired parameter is displayed, and then pressing the ▲▼ keys to change the value.

Menu Item	Display	Description	Range
Address	Communication CommAddr	Sets address node for control	1 to 247
Mode	Communication Mode	Turns on/off communications	OFF, Modbus
Baud Rate	Communication BaudRate	Sets interface speed	2400, 4800, 9600, 19.2K, 38.4K
Parity	Communication Parity	Sets parity for interface	None, Odd, Even

Real Time Clock Page

The Real Time Clock Page allows the control to be configured to have an operating mode begin automatically at a specific time on a specific day of the week. The real time clock feature is also used for using the Power Failure Recovery mode Time Limit feature (see Control Page). The real time clock is a seven day, 24 hour clock with battery backup.

To access the Real Time Clock Page, enter the Setup Mode. Press the Page key until Clock is displayed. Press the Menu key. Each parameter can be changed by pressing the Menu key until the desired parameter is displayed, and then pressing the ▲▼ keys to change the value.

Menu Item	Display	Description	Range
Day of the week	Clock Day	Setting for current day of the week	Sun, Mon, Tue, Wed, Thu, Fri, Sat
Time of day	Clock HH:MM	Setting for current time of the day	00:00 to 23:59
Reset clock	Clock UP to Reset CLK*	Press the ▲ key to set the clock to entered values	Ready, Done

* If the ▲ key is not pressed, the clock values will retain their original values. The display will change to Done if the clock is reset

Relay Outputs Page (optional)

The Relay Outputs Page configures the four alarm/event outputs. Each output has a dedicated indicator light and can be configured as a temperature alarm, profile event, or end of cycle output. Temperature alarms can be of type process high, process low, deviation high, deviation low, or deviation band.

To access the Relay Page, enter the Setup Mode (see description earlier in this manual). Press the Page key until Relay is displayed. Press the Select key until the desired relay output is selected. Press the Menu key. Each parameter can be changed by pressing the Menu key until the desired parameter is displayed, and then pressing the ▲▼ keys to change the value. To configure a specific relay, press the Select key until the desired relay appears.

NOTE: If Relay 0 appears, then no relays are installed (see relay kit assembly p.n. 144562).

Menu Item	Display	Description	Range
Type of relay	Relay 1 RelayType	Set function of relay	Off, Alarm, Cycl, Ev1 to Ev4
Action of relay	Relay 1 RelayAction	Set coil and contact state of relay	NDE, NE, NDEL, NEL*****
Type of alarm*	Relay 1 AlarmType	Set alarm type for relay	High, Low, Plus, Minus, Band
Alarm setpoint*	Relay 1 AlmHi/Lo SP	Setpoint for alarm	-73°C to 760°C (-100°F to 1400°F)
Alarm deviation*	Relay 1 AlmDevBand	Deviation band for alarm	1 to 56°C (1 to 100°F)
Inhibit alarm*	Relay 1 ALMInhibit	Inhibits alarm until "safe" condition is reached	En or Dis
Type of event**	Relay 1 EventType	Set event type for relay	Time or Temp
Event setpoint***	Relay 1 Event SP	Setpoint for temperature event	SPLoLim to SPUplim*****

(repeat for relay outputs 2-4, if available)

* appears only for alarm types

** appears only for time or temperature event types

*** appears only for temperature event types

Turning on the Alarm Inhibit function disables the alarm output on power up until the process temperature has reached a non-alarming condition ("safe").

If the relay output has been configured as latching, the RESET key must be pressed to return the output to the non-alarm state once the alarm condition has cleared.

Test Page

The Test Page contains parameters which allow manual control of the heat control and optional relay outputs and should be used only for testing the functionality of the control instrument. Do not operate the oven for processes using the Test Page.

To access the Test Page, enter the Setup Mode (see description earlier in this manual). Press the Page key until Test is displayed. Press the Menu key. Each parameter can be changed by pressing the Menu key until the desired parameter is displayed, and then pressing the ▲▼ keys to change the value.

Menu Item	Display	Description	Range
Heater output	Test HeatOut	Activate SSR output 100%	On
High limit relay	Test HiLimOut	Activate high limit alarm (de-energize relay)	On
Relay 1 output	Test Rly1 Out	Energize relay output 1	On
Relay 2 output	Test Rly2 Out	Energize relay output 2	On
Relay 3 output	Test Rly3 Out	Energize relay output 3	On
Relay 4 output	Test Rly4 Out	Energize relay output 4	On
HiLim Sensor	Test HL Temp (push and hold up)	Displays sensor reading*	

*Push ▲ key to refresh display

When the Test Page is entered, all outputs are automatically set to off. When exiting the Test Page, all outputs will return to their previous condition regardless of the Test Page settings.

Zone Calibration Page

The Zone Calibration Page allows adjustment of the displayed temperature versus the actual temperature measured by the control thermocouple. This may be desirable in certain conditions where the center of the oven chamber is not the same temperature as the control thermocouple. This may occur when the oven is not allowed to soak at a constant temperature for long periods of time, or the oven is being used at high temperature.

There is also a Factory Calibration Recovery which will restore the factory calibration values when the control was first shipped by the manufacturer. This may be helpful if the calibration has been lost and a calibration instrument is not readily available. To use the Factory Calibration Recovery feature only, bypass the Zone 1 and Zone 2 calibration parameters by pressing the Menu key.

To access the Zone Calibration Page, enter the Setup Mode (see description earlier in this manual). Press the Page key until Zone Cal is displayed. Press the Menu key. Each parameter can be changed by pressing the Menu key until the desired parameter is displayed, and then pressing the ▲▼ keys to change the value.

Menu Item	Display	Description	Range
Zone 1 actual	Zone Cal Zone1Act	Point at which Zone 1 is set (center of chamber)	-73°C to 760°C (-100°F to 1400°F)
Zone1 displayed	Zone Cal Zone1Dis	Desired displayed value for Zone 1 setting	-73°C to 760°C (-100°F to 1400°F)
Zone 2 actual	Zone Cal Zone2Act	Point at which Zone 2 is set (center of chamber)	-73°C to 760°C (-100°F to 1400°F)
Zone2 displayed	Zone Cal Zone2Dis	Desired displayed value for Zone 2 setting	-73°C to 760°C (-100°F to 1400°F)
Factory calibration*	Zone Cal FactCal	Restores the factory calibration values	Ready or Done (push- key)

*Only use when no calibration instrument is available, push ▲ key to restore factory values.

Press the Page key to exit the Zone Calibration Page.

Two points of display calibration (temperature offset) are available. The Zone 1 Actual and Zone 2 Actual parameters are the two temperature points where the offset is to take effect. These values are adjustable. The Zone 1 and Zone 2 Displayed parameters are the values the user wishes to have displayed at the Actual temperatures, and are also adjustable.

As an example, the control is displaying 400°F with the setpoint being 400°F, but the center of the oven chamber is actually 395°F. This can occur due to oven wall losses and product loading variations. The operator may change the zone calibration so that the center of the oven is 400°F when the display reads 400°F. In this case operate the oven in manual mode with a setpoint of 400°F. Record the center of the chamber (as measured with an independent sensor). Access the Zone Calibration Page and enter this measured value as the Zone 2 Actual value, with 400° as the Zone 2 Displayed value.

Zone 1 can be adjusted using the same method at a lower temperature. The instrument will then create a linear offset based on the Zone1 and Zone 2 Actual temperature values. Note that the oven does not have to be heated to adjust the zone parameters if the zone values are known based on prior experience.

Sensor Calibration Page

The Sensor Calibration Page has parameters which can change the internal calibration of the temperature sensor input signal. There is a low and high calibration point for both the control sensor and the high limit sensor. To calibrate the instrument, allow the control to warm up for at least 30 minutes.

To access the Sensor Calibration Page, enter the Setup Mode (see description earlier in this manual). Press the Page key until Control Sensor is displayed. Press the Menu key.

The control may have the optional process value retransmission output feature. The output is a 1 to 5VDC signal. To calibrate the retransmit signal, the RetOutLo and RetOutHi values from the Control Page must be known. You may bypass calibrating the control and high limit sensor input to access only the retransmit calibration by pressing the Menu key until RetCalLo is displayed (skip steps 4-17).

To re-calibrate the instrument:

1. Disconnect the control and high limit sensor thermocouples.
2. Connect a calibration instrument with a type J thermocouple output to the control sensor input. Allow the control to warm up at least 30 minutes.
3. Access Setup Mode.
4. Press Page key until **-100F** is displayed.
5. Press Menu key until **Ctrl Sens -100F** is displayed.
6. With **Ctrl Sens -100F** displayed, adjust the calibration instrument to Type J thermocouple, -100 degrees Fahrenheit output.
7. Wait 30 seconds. Press the ▲ key.
8. With **Ctrl Sens 1400F** displayed, adjust the calibration instrument to 1400 degrees Fahrenheit output (Type J thermocouple).
9. Wait 30 seconds. Press the ▲ key.
10. When the control displays **Ctrl Sens Done**, disconnect the calibration instrument from the control sensor input and connect it to the high limit sensor input. Reconnect the control sensor thermocouple.
11. Press the Menu key until **HL Sens -100F** is displayed.
12. With the control displaying **HL Sens -100F**, adjust the calibration instrument to -100 degrees Fahrenheit output (Type J thermocouple).
13. Wait 30 seconds. Press the ▲ key.
14. With the control displaying **HL Sens 1400F**, adjust the calibration instrument to 1400 degrees Fahrenheit output (Type J thermocouple).
15. Wait 30 seconds. Press the ▲ key.
16. When the control displays **HL Sens Done**, disconnect the calibration instrument from the high limit sensor input. Re-connect the high limit sensor thermocouple.
17. To skip calibration of the retransmit signal, press the Page key twice to exit the Sensor Calibration Page.
18. To calibrate the retransmit signal, press the Menu key until **RetCalLo** is displayed.
19. Connect a calibration instrument with a type J thermocouple output to the control sensor input.
20. Connect a voltage measurement device to the retransmit output terminals.
21. Set the calibration instrument output to the temperature value of the **RetOutLo** parameter from the Control Page.
22. Adjust the **RetCalLo** * value using the ▲▼ keys until the voltage measurement device reads 1VDC.
23. Press the Menu key.
24. Set the calibration instrument output to the temperature value of the **RetOutHi** parameter from the Control Page.
25. Adjust the **RetCalHi** * value using the ▲▼ keys until the voltage measurement device reads 5VDC.
26. Press the Menu key.
27. Press the Page key to exit the Sensor Calibration Page.
28. Calibration is now complete. Disconnect the calibration instrument and voltage measurement device (if used).
29. Verify that the control and high limit sensor thermocouples are connected.

Menu Item	Display	Description	Range
Control Sensor Cal	Ctrl Sens -100F	Calibrate Sensor Low End	-100 to 1400°F
	Ctrl Sens 1400F	Calibrate Sensor High End	-100 to 1400°F
	Ctrl Sens Done	Control Sensor Cal Complete	(read only)
HiLim Sensor Cal	HL Sens -100F	Calibrate HiLim Sensor Low End	-100 to 1400°F
	HL Sens 1400F	Calibrate HiLim Sensor High End	-100 to 1400°F
	HL Sens Done	HiLim Sensor Cal Complete	(read only)
Retransmit Cal	RetCalLo XXXX *	Calibrate Retransmit Output Low	0 to 4096**
	RetCalHi XXXX *	Calibrate Retransmit Output High	0 to 4096***

*Note that the actual RetCalLo and RetCalHi values displayed are of no importance.

Enable Page

The Enable Page controls access to the other Setup Pages. The setpoint minimum and maximum values, and the security passwords are also set on the Enable Page.

To access the Enable Page, enter the Setup Mode using a level 2 access code (see description earlier in this manual). Press the Page key until Enable is displayed. Press the Menu key. Each parameter can be changed by pressing the Menu key until the desired parameter is displayed, and then pressing the ▲▼ keys to change the value.

NOTE: Changing the enable to “yes” for each page will allow access to the page in Level 1 security.

Menu Item	Display	Description	Range
Profiles	Enable Profile 1-8	Controls access to Program Page	Yes or No
Autostart	Enable Auto Start	Controls access to AutoStart Page	Yes or No **
PID	Enable PID	Controls access to PID Page	Yes or No
Control	Enable Control	Controls access to Control Page	Yes or No
Communication	Enable Communication	Controls access to Communication Page	Yes or No **
Real Time Clock	Enable Clock	Controls access to Real Time Clock Page	Yes or No **
Relay outputs	Enable Relay 1-4	Controls access to Relay Page	Yes or No **
Test	Enable Test	Controls access to Test Page	Yes or No
Zone Calibration	Enable Zone Cal	Controls access to Zone Calibration Page	Yes or No
Sensor Calibration	Enable Sensor Cal	Controls access to Sensor Calibration Page	Yes or No
Setpoint lower limit	Enable SPLowerLim	Sets minimum setpoint allowed	-73°C to 759°C (-100°F to 1399°F)
Setpoint upper limit	Enable SPUpperLim	Sets maximum setpoint allowed	-73°C to 760°C (-100°F to 1400°F)
High limit overhead	Enable HiLimOH	Sets maximum high limit setpoint allowed*	3 to 11°C (5 to 20°F)*
Password level 1	Enable Password 1	Sets password for access level 1	0 to 999
Password level 2	Enable Password 2	Sets password for access level 2	0 to 999
Setpoint Change	Enable SPChange	Set to DISABLE to lock out setpoint and high limit setpoint changes in Manual and Timer Modes	Yes or No
Analog Output Type	Enable Analog Type	Sets Analog Output type	Ctrl or Proc

* Maximum high limit setpoint = SPUpperLim + HiLimOH

** If the controller does not have this feature, “No” is the only option.

Digital Inputs (optional)

The Protocol Plus control can be run by external inputs wired to the control from an external source such as a PLC or control panel switches. The external run operation can Run, Hold or Stop profiles 1 through 7 (profile 8 can not be operated externally). Refer to the table below for the inputs required for the desired operation. NOTE: A profile must be created in the program page before trying to run a profile number.

Input 1	Input 2	Input 3	Profile Selected
ON	OFF	OFF	1
OFF	ON	OFF	2
ON	ON	OFF	3
OFF	OFF	ON	4
ON	OFF	ON	5
OFF	ON	ON	6
ON	ON	ON	7
OFF	OFF	OFF	none

To start the selected profile, set Input 1, 2, 3 or 4 to ON.

To hold a profile, set Input 4 to OFF.

To stop a profile, set all inputs to OFF.

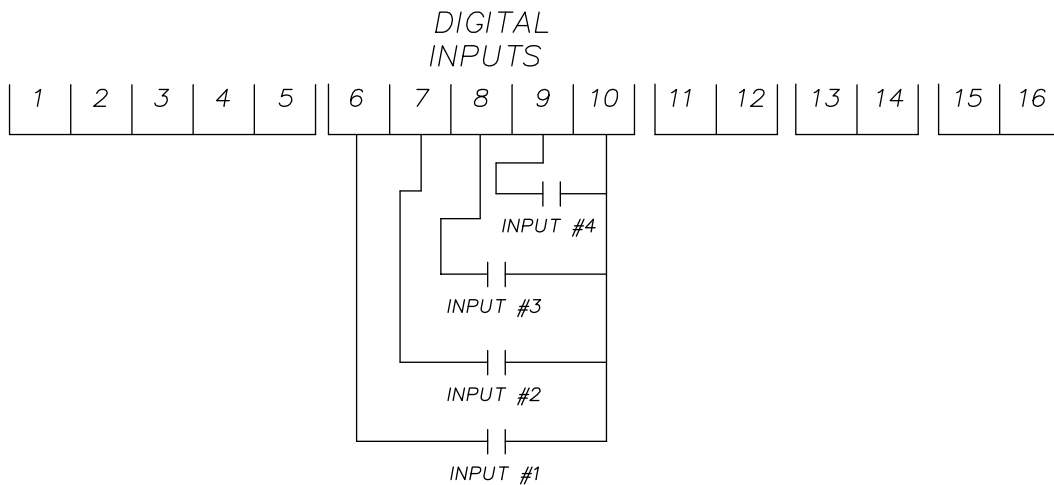

Digital Inputs

Error Messages and Alarms

The Alarm Status **Hi-limit** LED is flashing. This indicates a problem with the thermocouple, or the Hi-limit setpoint has been exceeded. Once the problem has corrected, press the Reset pushbutton.

The Alarm Status **Soak** LED is flashing. This indicates that the oven temperature has not entered or dropped out of the soak band and the soak timer has stopped.

The top LED Display reads **OPEN** and the lower LCD display reads **CONTROL SENS ERR**. This indicates that the Control thermocouple is disconnected or broken. Repair or replace the thermocouple.

The lower LCD display reads **HI-LIM SENS ERR**. This indicates that the Hi-limit thermocouple is disconnected or broken. Repair or replace the thermocouple.

The lower LCD display reads **HIGH LIMIT ALARM**. This indicates that the Hi-limit temperature setpoint has been exceeded. Determine if the setting is set too close to the setpoint, the SSR is defective, or the calibration is incorrect.

Note: The lower LCD display intermittently reads **HL Temp**. This is not an error message, but the Hi-limit thermocouple temperature reading.

Quick Reference and Default Values

Program Page

Menu Item	Display	Default	Range	Setting
Ramp Time Seg 1	Pro-1 Seg-1 Ramp Time	00:00	00m00s to 99h59s	
Event 1 Set Value	Pro-1 Seg-1 Ramp Event 1	Off	Off, On	
Event 2 Set Value	Pro-1 Seg-1 Ramp Event 2	Off	Off, On	
Event 3 Set Value	Pro-1 Seg-1 Ramp Event 3	Off	Off, On	
Event 4 Set Value	Pro-1 Seg-1 Ramp Event 4	Off	Off, On	
Soak Temp Seg 1	Pro-1 Seg 1 Soak Temp	68°F	SPLowerLim to SPUpperLim *	
Soak Time Seg 1	Pro-1 Seg 1 Soak Time	00:00	00m00s to 99h59s	
Event 1 Set Value	Pro-1 Seg-1 Soak Event 1	Off	Off, On	
Event 2 Set Value	Pro-1 Seg-1 Soak Event 2	Off	Off, On	
Event 3 Set Value	Pro-1 Seg-1 Soak Event 3	Off	Off, On	
Event 4 Set Value	Pro-1 Seg-1 Soak Event 4	Off	Off, On	
(repeat for segments 2-8)				
High Limit Setpoint	Pro-1 Hi-Lim SP	Max HiLimSP	MinHiLimSP to MaxHiLimSP *, Band **	
Loop From	Pro-1 Loop From XX	No	No, Seg-1 to Seg-8	
Loop To	Pro-1 Loop To XX	No	No, Seg-1 to Seg-8	
Loop Count	Pro-1 Loop Number	0	0 to 99	
Profile Link	Pro-1 Link To XX	Stop	Standby***, Stop, Hold, Pro-1 to Pro-8	
Guaranteed Soak	Pro-1 Guar Band	Off	Off, 1 to 778°C (1400°F)	
(repeat for profiles 2-8)				

* See Enable Page

** Band value is set on Control Page

*** If Standby

1. Cycle Complete LED indication goes ON.
2. Controller beeps if **End Of Cycle** beep is enabled.
3. Heater/control output keeps controlling oven temperature at last Soak setpoint.
4. All events programmed (if relay cards installed and programmed as an event) for the last Soak Segment stays active.

Programming Table

Profile Number _____

Profile Name _____

Segment	Ramp					Soak						
	Time	Events				Temperature	Time	Events				
		1	2	3	4			1	2	3	4	
1												
2												
3												
4												
5												
6												
7												
8												
High Limit Setpoint												
Loop From Seg												
Loop To Seg												
Loop Number												
Link To Pro												
Guar Soak Band												

Autostart

Menu Item	Display	Default	Range	Setting
Enable Autostart	Auto Start Enable	No	No, Yes	
Sunday mode	Auto Start Sun Mode	Off	Off, Manual, Timer, Pro-1 to Pro-8	
Sunday time	Auto Start Sun Time	00:00	00:00 to 23:59	
Monday mode	Auto Start Mon Mode	Off	Off, Manual, Timer, Pro-1 to Pro-8	
Monday time	Auto Start Mon Time	00:00	00:00 to 23:59	
Tuesday mode	Auto Start Tue Mode	Off	Off, Manual, Timer, Pro-1 to Pro-8	
Tuesday time	Auto Start Tue Time	00:00	00:00 to 23:59	
Wednesday mode	Auto Start Wed Mode	Off	Off, Manual, Timer, Pro-1 to Pro-8	
Wednesday time	Auto Start Wed Time	00:00	00:00 to 23:59	
Thursday mode	Auto Start Thu Mode	Off	Off, Manual, Timer, Pro-1 to Pro-8	
Thursday time	Auto Start Thu Time	00:00	00:00 to 23:59	
Friday mode	Auto Start Fri Mode	Off	Off, Manual, Timer, Pro-1 to Pro-8	
Friday time	Auto Start Fri Time	00:00	00:00 to 23:59	
Saturday mode	Auto Start Sat Mode	Off	Off, Manual, Timer, Pro-1 to Pro-8	
Saturday time	Auto Start Sat Time	00:00	00:00 to 23:59	

PID

Menu Item	Display	Default	Range	Setting
Display units	PID Temp Unit	°C	°C or °F	
Proportional band	PID Prop Band	6°C	1 to 56°C (1 to 100°F)	
Integral reset	PID Reset	2	0 to 100 seconds/repeat	
Derivative Rate	PID Rate	0	0 to 500 seconds	
AutoTune	PID AutoTune	Disable	Disable, Enable	

Control

Menu Item	Display	Default	Range	Setting
Cycle Time	Control Cycle Time	1	1 to 60 seconds	
High limit setpoint	Control Hi-Lim SP	Max HiLimSP	MinHiLimSP - MaxHiLimSP*	
High limit band	Control Hi-Lim Band	Off	Off, 3°C to 11°C (5°F to 20°F)	
Power fail recovery	Control PwrFRec	Stop	Stop, Restart, Hold, Resume	
Recovery time limit	Control PwrFTime	00m00s	00m00s to 99m59s	
Powerup start enable	Control EPwrStrt	Dis	Dis, En	
Powerup Start Mode	Control StrtMode	Off	Off, Manual, Timer, Pro-1 to Pro-8	
Hysteresis	Control Hyst	3°C	1°C to 56°C (1°F to 100°F)	
Process out low	Control RetOutLo	80°C	-73°C to 760°C (-100°F to 1400°F)	
Process out high	Control RetOutHi	400°C	-73°C to 760°C (-100°F to 1400°F)	
Time scale	Control TimeScale	hh:mm	hh:mm or mm:ss	
Key press beep	Control KeyBeep	On	On or Off	
End of cycle beep	Control EOCBeep	Off	On or Off	
Alarm beep	Control AlarmBeep	Off	On or Off	

*see Enable Page

Communication (optional)

Menu Item	Display	Default	Range	Setting
Address	Communication CommAddr	1	1 to 247	
Mode	Communication CommMode	OFF	OFF, Modbus	
Baud rate	Communication Baud Rate	19.2K	2400, 4800, 9600, 19.2K, 38.4K	
Parity	Communication Parity	None	None, Odd, Even	

Real Time Clock

Menu Item	Display	Default	Range	Setting
Day of the week	Clock Day	Mon	Sun, Mon, Tue, Wed, Thu, Fri, Sat	
Time of day	Clock HH:MM	00:00	00:00 to 23:59	
Reset clock	Clock UP to Reset CLK*	Ready	Ready, Done	

* if the ▲ key is not pressed, the clock values will retain their original values, the display will change to Done if the clock is reset

Relay Outputs (optional)

Push Select key to select relay. If Relay 0 appears, no relays are installed

Menu Item	Display	Default	Range
Type of relay	Relay 1 RelayType	Off	Off, Alarm, Cycl, Ev1 to Ev4
Action of relay	Relay 1 RelayAction	NDE	NDE, NE, NDEL, NEL*****
Type of alarm*	Relay 1 AlarmType	High	High, Low, Plus, Minus, Band
Alarm setpoint*	Relay 1 AlmHi/Lo SP	538°C	-73°C to 760°C (-100°F to 1400°F)
Alarm deviation*	Relay 1 AlmDevBand	3°C	1 to 56°C (1 to 100°F)
Inhibit alarm*	Relay 1 ALMinhibit	On	En or Dis
Type of event**	Relay 1 EventType	Time	Time or Temp
Event setpoint ***	Relay 1 Event SP	SPUpLim	SPLoLim to SPUpLim****

(repeat for relay outputs 2-4, if available)

* appears only for alarm types

** appears only for time or temperature event types

*** appears only for temperature event types

**** see enable page

***** Normally de-energized and non-latching, normally energized and non-latching, normally de-energized and latching, normally energized and latching

Table of Settings

Relay	Type	Action	Alarm/ Event Type	Setpoint	Alarm Deviation	Alarm Inhibit

Test

Menu Item	Display	Default	Range	Setting
Heater output	Test HeatOut	Off	On	
High limit relay	Test HiLimOut	Off	On	
Relay 1 output	Test Rly1 Out	Off	On	
Relay 2 output	Test Rly2 Out	Off	On	
Relay 3 output	Test Rly3 Out	Off	On	
Relay 4 output	Test Rly4 Out	Off	On	
High Limit Sensor	Test HL Temp	(sensor reading)		

Zone Cal

Menu Item	Display	Default	Range	Setting
Zone 1 actual	Zone Cal Zone1Act	38°C	-73°C to 760°C (-100°F to 1400°F)	
Zone1 displayed	Zone Cal Zone1Dis	38°C	-73°C to 760°C (-100°F to 1400°F)	
Zone 2 actual	Zone Cal Zone2Act	260°C	-73°C to 760°C (-100°F to 1400°F)	
Zone2 displayed	Zone Cal Zone2Dis	260°C	-73°C to 760°C (-100°F to 1400°F)	
Factory calibration*	Zone Cal FactCal	Ready	Ready or Done (push- key)	

*only use when no calibration instrument is available

Sensor Cal

Menu Item	Display	Default	Range	Setting
Control Sensor Cal	Ctrl Sens 0F	-100°F	-100 to 1400°F	
	Ctrl Sens 1000F	1400°F	-100 to 1400°F	
	Ctrl Sens Done	Done	(read only)	
HiLim Sensor Cal	HL Sens 0F	-100°F	-100 to 1400°F	
	HL Sens 1000F	1400°F	-100 to 1400°F	
	HL Sens Done	Done	(read only)	
Retransmit Cal	RetCalLo XXXX *	0	0 to 4096**	
	RetCalHi XXXX *	4096	0 to 4096***	

* note that the actual RetCalLo and RetCalHi values displayed are of no importance.

** press ▲▼ keys until retransmission output = 1VDC

*** press ▲▼ keys until retransmission output = 5VDC

Enable Page

Menu Item	Display	Default	Range	Setting
Profiles	Enable Profile 1-8	Yes	Yes or No	
Autostart	Enable Auto Start	No	Yes or No **	
PID	Enable PID	Yes	Yes or No	
Control	Enable Control	No	Yes or No	
Communication	Enable Communication	No	Yes or No **	
Real Time Clock	Enable Clock	No	Yes or No **	
Relay outputs	Enable Relay 1-4	No	Yes or No **	
Test	Enable Test	No	Yes or No	
Zone Calibration	Enable Zone Cal	No	Yes or No	
Sensor Calibration	Enable Sensor Cal	No	Yes or No	
Setpoint lower limit	Enable SPLowerLim	20°C	-73°C to 759°C (-100°F to 1399°F)	
Setpoint upper limit	Enable SPUpperLim	260°C	-73°C to 760°C (-100°F to 1400°F)	
High limit overhead	Enable HiLimOH	5°C	3 to 11°C (5 to 20°F)*	
Password level 1	Enable Password 1	1	0 to 999	
Password level 2	Enable Password 2	2	0 to 999	
Manual/Timer mode setpoint change	Enable SPChange	Yes	Yes or No	
Analog Output Type	Enable Analog Type	Proc	Ctrl or Proc	

* Maximum high limit setpoint (MaxHiLimSP) = SPUpperLim + HiLimOH
 Minimum high limit setpoint (MinHiLimSP) = SPLowerLim + HiLimOH

** If the controller does not have this feature, "No" is the only option.

Technical Specifications

UL, cUL listed:	UL file E136675
CE compliance to:	<ul style="list-style-type: none">• EMC Directive 89-366/EEC• European Standard EN55011/1991• European Standard EN50082-2/1995
Power supply:	<ul style="list-style-type: none">• 100 to 240 VAC +10% -15%, 50-60Hz, 30VA Maximum• 12 to 24 VAC/VDC +/-10%, DC to 60Hz, 30VA Maximum
Temperature:	<ul style="list-style-type: none">• Storage -20 to 60°C• Operating 0 to 50°C
Humidity:	90% or less, non-condensing
Sensor inputs:	<ul style="list-style-type: none">• Type J thermocouple -73°C to 760°C (-100°F to 1400°F)• Input impedance 1M ohm or greater• Common mode noise rejection of 140db@60Hz• Common mode input voltage of +/-12.0VDC• Sample rate of at least 1 sample per second• Stability of +/- 0.5°C per 5°C change in ambient temperature• Repeatability of +/- 0.5°C, or +/-0.1% of sensed temperature (whichever is greater)• Accuracy (@ 77°F +/-0.2 percent of span (+/-3°F)• Supply Voltage Influence of +/-0.5°C per 10% change in nominal line voltage
Temperature display:	<ul style="list-style-type: none">• 1 degree resolution (C or F)• Accuracy after calibration of +/- 1°C, or +/-0.2% of sensed temperature (whichever is greater) @25°C• Four-digit seven-segment LCD, 0.43 inches high (11mm)• Readout Stability (+/-1°F/10°F Change in ambient temperature)
Message display:	<ul style="list-style-type: none">• Two-line, 16 alpha-numeric 5x7 dot matrix characters per line• 0.2 inches high (5mm)
Time base:	+/- 4 seconds accuracy in 24 hours
Heat control output:	SSR Drive 24VDC nominal @ 70mA
Relay output: (plug-in module)	Form A dry contact, rated 3 amps @ 24-264VAC
Retransmit output:	1 to 5 VDC into > 100K ohm load
Communications: (plug-in module)	<ul style="list-style-type: none">• RS232 Single drop, isolated• RS422 Multi-drop, isolated• RS485 Multi-drop, isolated
Remote inputs: (plug-in module)	Dry-contact closure type with less than 250 ohm ON resistance
Front panel:	NEMA 4X (with gasket)
Dimensions:	3.57H x 7.24W x 2.84D inches (91H x 184W x 72D mm)
Panel opening:	3.63H x 7.30W inches (92H x 185W mm)

APPENDIX: DRAWINGS

The following pages contain electrical drawings for the LCC/LCD2-14-3.

