

THRIVING ON INNOVATION

Despatch
INDUSTRIES

**RAD 1-42-2E
WITH PROTOCOL *PLUS*™
INSTRUCTION MANUAL**

C-192
PN 146297
REVISION N
3/2009

SERVICE AND TECHNICAL SUPPORT

service parts: 1-800-473-7373

international service/main: 1-952-469-8230

service fax: 1-952-469-8193

service@despatch.com

GLOBAL HEADQUARTERS

phone: 1-888-DESPATCH (1-888-337-7282)

international/main: 1-952-469-5424

fax: 1-952-469-4513

sales@despatch.com

www.despatch.com

8860 207th Street West
Minneapolis, MN 55044 USA

Despatch
INDUSTRIES

MINNEAPOLIS • SHANGHAI • BERLIN • SINGAPORE • TAIPEI

Notice

Users of this equipment must comply with operating procedures and training of operation personnel as required by the Occupational Safety and Health Act (OSHA) of 1970, Section 6 and relevant safety standards, as well as other safety rules and regulations of state and local governments. Refer to the relevant safety standards in OSHA and National Fire Protection Association (NFPA), section 86 of 1990.

Caution

Setup and maintenance of the equipment should be performed by qualified personnel who are experienced in handling all facets of this type of system. Improper setup and operation of this equipment could cause an explosion that may result in equipment damage, personal injury or possible death.

Thank you for choosing Despatch Industries. We appreciate the opportunity to work with you and to meet your heat processing needs. We believe that you have selected the finest equipment available in the heat processing industry.

At Despatch, our service does not end after the purchase and delivery of our equipment. For this reason we have created the Service Products Division within Despatch. The Service Products Division features our Response Center for customer service. The Response Center will direct and track your service call to ensure satisfaction.

Whenever you need service or replacement parts, contact the Response Center at 1-800-473-7373: FAX 612-781-5353.

Thank you for choosing Despatch.

Sincerely,

Despatch Industries



Standard Products Product Warranty

Products Covered by this Warranty

This warranty (the "warranty") applies to the following Despatch products: LEB, LBB, LAC, LCC, LCD, LLD, RAD, RFD, LND, RTFO, TAD, TFD, PR, PN, PW, PTC and the following Ransco products: RTH, RTS, 900 Series.

Parts and Materials

Despatch warrants all parts and materials to be free from defects in material and workmanship for a period of:

1. Five (5) years from date of shipment for laboratory oven electric heaters.
2. Three (3) years from the date of shipment for Protocol Plus and DES 2000 temperature controllers; and
3. One (1) year from the date of shipment, or 2,000 hours of operation, whichever occurs first, for all other components of products covered by this Warranty.

During the applicable Warranty period, Despatch will repair or replace, at Despatch's option, parts and materials covered by this Warranty.

Labor

During the first 90 days of the Warranty period, Despatch will pay labor costs incurred to remove defective parts and materials, and to reinstall repaired or replacement parts or materials; provided, however, that Despatch's obligation to pay such labor costs shall be subject to the limitation that the removal and/or reinstallation service must be performed by a Despatch-authorized technician from Despatch's worldwide network of factory-trained professionals at a location within the contiguous United States.

Transportation Costs

All transportation costs to transport defective parts or materials to Despatch and to transport repaired or replacement parts or materials to Customer shall be the responsibility of Despatch.

Terms and Conditions

This Warranty shall be deemed valid and binding upon Despatch if and only if the Customer:

1. Installs, loads, operates, and maintains the covered product supplied hereunder in accordance with the instruction manual provided upon delivery and product labeling affixed to the subject equipment;
2. If applicable, follows the Emergency Procedure set forth in this Warranty; and
3. Contacts Despatch's Helpline at 1-800-473-7373 for assistance in diagnosing and troubleshooting the problem immediately upon discovering any damage or malfunction.

Despatch's reasonable determination as to whether a repair, replacement, or service is covered by this Warranty shall be final and binding.

Exclusions

This Warranty DOES NOT cover,

1. Damage or malfunctions, or expenses incurred in the process of diagnosing and/or repairing damage or malfunctions, resulting from any of the following: operator

THE REPRESENTATION AND WARRANTIES SET FORTH HEREIN ARE EXCLUSIVE AND IN LIEU OF, AND CUSTOMER HEREBY WAIVES AND DISCLAIMS RELIANCE UPON, ALL OTHER REPRESENTATIONS AND WARRANTIES OF EVERY KIND WHATSOEVER WHETHER EXPRESS OR IMPLIED, OR ARISING BY OPERATION OF LAW OR IN EQUITY, OR BY COURSE OF PERFORMANCE OR DEALING OR USAGE OF TRADE, INCLUDING, WITHOUT LIMITATION, ANY IMPLIED WARRANTIES OF MERCHANTABILITY OR OF FITNESS FOR A PARTICULAR PURPOSE.

THIS WARRANTY IS PERSONAL TO THE CUSTOMER AND MAY NOT BE TRANSFERRED OR ASSIGNED. ALL LIMITATIONS HEREUNDER, HOWEVER SHALL BE BINDING ON ALL SUCCESSORS AND ASSIGNS OF CUSTOMER.

error, misuse, abuse, inadequate preventative maintenance, normal wear and tear, service or modifications by other than Despatch authorized technicians, use of the covered product that is inconsistent with the operation manual or labeling, acts of nature (including, without limitation, floods, fire, earthquake, or acts of war or civil emergency), internal or external corrosion, or non-conforming utilities (including, without limitation, electrical, fuel supply, environmental and intake/exhaust installations);

2. Repair or replacement of parts or materials designed and intended to be expendable or consumable; refrigerants, filters, lamps;
3. Routine maintenance; or
4. Labor costs incurred for troubleshooting, diagnostics, or testing (except for testing required to verify that a covered defective part or material has been repaired).

Limitations of Liability

Despatch shall not, in any event, be liable for indirect, special, consequential, incidental, or punitive damages or penalties of any kind, including without limitation loss of revenue, profits or business opportunities resulting from interruption of process or production. In no event shall Despatch be liable for damages in excess of the amounts paid by Customer to Despatch with respect to the applicable product(s). This Warranty does not cover, and Despatch shall not be liable for any losses, costs, damages or expenses resulting from delays in diagnosing or repairing the products, supplying or obtaining replacement parts of materials, strikes, labor stoppages or shortages, fires, accidents, government acts or regulations, or any other causes beyond the control of Despatch.

Non-Compliance By Customer

Despatch reserves the right to suspend and withhold service under this Warranty in the event of non-compliance by the Customer to any terms and conditions of this Warranty or the applicable purchase order or invoice. Further, Despatch shall not be liable for any loss of production, expenses, and inconveniences incurred due to such suspension.

Customer Furnished Equipment Warranty Limitation

This Warranty does not cover diagnosis or repairs of defects in or caused by, lack of performance of, or fitness for purpose of customer-supplied parts or equipment unless specifically noted in the Despatch written order acceptance confirmation.

Performance Commitment

Despatch provides no guarantee of process performance or fitness for purpose, unless specifically noted otherwise in Despatch written order acceptance confirmation. Despatch is providing equipment with design parameters specific only to its equipment.

Procedure Upon Discovery of Defects and Emergencies

In the event Customer becomes aware of any defect in the application products, Customer must immediately: (a) shut off fuel or energy supply (gas and electricity); (b) call for emergency assistance, if needed, and (c) notify Despatch Service.

Service

Worldwide Phone 952-469-8230; Worldwide Fax 952-469-8193; North American Phone 800-473-4373
e-mail service@despatch.com; www.despatch.com

Please see reverse side for other service offerings

Despatch Industries

Advantage Service Assurance Program (ASAP)

CONTACT: DESPATCH SERVICE AGREEMENTS SPECIALIST at 800-473-7373 or 952-469-8230
or e-mail: service@despatch.com

Despatch continues to deliver exceptional products backed by a strong sense of responsibility and drive for long term customer satisfaction. Your partnership with Despatch can offer even higher value through your subscription to one of Despatch's Advantage Service Assurance Program(ASAP).

Warranty

Despatch's exclusive, comprehensive service programs start with the 1 year parts only warranty which is described on the other side of this document. This warranty can be expanded immediately to meet your most stringent service needs. Despatch Service Products Group will be able to answer your service questions and provide a quotation for the immediate expansion of your product warranty. Call 800-473-7373 or 952-469-8230; or e-mail service@despatch.com.

Immediate Service Response

The key to an effective service program is response. Wherever your location, Despatch is only a phone call away. Our U.S. and Canadian customers can reach Despatch at 1-800-473-7373. Worldwide customers can call 1-952-469-8230 or FAX 1-952-469-8193. Our Customer Service Technicians have over 150 years combined experience and access to detailed design and manufacturing documentation specific to your Despatch unit(s). This exacting level of service is a benefit only Despatch can provide and means that you can expect speedy, accurate and the most cost effective response.

Field Service Network

A worldwide network of factory trained Service Professionals is available to support your Despatch equipment. From routine repair to certified instrument calibration, the Despatch service network is positioned to respond to your needs. As a manufacturer of custom equipment, our service programs are customized to meet your specific needs regarding:

1. Service scope
2. Response time
3. Preventive maintenance frequency and content
4. Payment method

Sustained Service Support

At Despatch, long term customer satisfaction means more than just responding quickly and effectively to our customers' service needs. It means offering comprehensive customer support well beyond the scope and duration of our initial warranty. Despatch offers two basic service packages which are customized to each individual customer's need. These service packages are titled Full Service and Preventive Maintenance Plus+ service agreement products. Each is unique in the industry and offer the following benefits:

1. Priority response for minimum production interruption
2. Preventive maintenance for longer product life
3. Discounts on parts and services
4. Various payment plans to ease budgeting and recording expenses
5. Reduce purchase ordering costs

PREFACE

This manual is your guide to the Despatch oven. It is organized to give you the information you need quickly and easily.

The INTRODUCTION section provides an overview of the Despatch oven.

The THEORY OF OPERATION section describes oven function and damper operation.

The OVEN INSTRUCTIONS and CONTROL INSTRUCTIONS sections provide directions on unpacking, installing, operating and maintaining the Despatch oven and its Protocol Plus™ control.

The APPENDIX section contains a temperature scale conversion table and instructions on setting up an optional MRC5000 data recorder.

An efficient way to learn about the oven would be to read the manual while working with the corresponding oven control system. This will give you practical hands-on experience with information in the manual and the oven.

Before operating the equipment, be sure you understand all of the technical information contained in this manual. Information skipped, not understood or misunderstood could create the possibility of operating the equipment in an unsafe manner. This can cause damage to the oven or personnel or reduce the efficiency of the equipment.

NOTE:
Read the entire INTRODUCTION and THEORY OF OPERATION before installing the oven.

WARNING:
Failure to heed warnings in this instruction manual and on the oven could result in personal injury, property damage or death.

- Revision B: Drawings added
- Revision C: Drawings updated
- Revision D: Preface modified
"Operating Environment" note added to Operating section
- Revision E: Modified per Rev C Protocol Plus software
- Revision F: Corrections to Protocol Plus software description, correction to list of included materials
- Revision G: Update Despatch Warranty
- Revision H: Update to Protocol Plus Version 4.0.
- Revision I: Drawings updated
- Revision J: Drawings updated
- Revision L: Revised Protocol Plus numbers. Updated Despatch address.
- Revision M: Revised warranty
- Revision N: Updated Control Section

TABLE OF CONTENTS

PREFACE	I
INTRODUCTION	1
Special Features	1
Specifications	2
Dimensions.....	2
Capacities.....	2
Temperature.....	3
Power	4
THEORY OF OPERATION.....	5
Damper Control.....	6
Determining Damper Settings	6
Full Closed Position	6
Full Open Position	7
Other Damper Settings	7
OVEN INSTRUCTIONS.....	8
Unpacking and Inspection	8
Set-up.....	9
Operating	10
Operating Environment	10
Loading the Oven	11
Pre-Startup Checklist	12
Startup.....	12
CONTROL	13
Theory of Control Operation.....	13
Operating Modes	15
Setup Mode	15
Fast Start Mode	15
High Limit	16
Indicators.....	16
Displays.....	17
Key Functions.....	17
Outputs.....	18
Relay (Continued)	19
Communication	19
Optional Software.....	19
INSTRUCTIONS	20
Start-Up.....	20
Operation	21
Manual Mode.....	21
Timer Mode	22
Profile Mode	23
Auto Start Mode	23
Setup Mode	24
Instructions for Setup Mode Pages	25
Program Page	25
Profile #	27
Sample Profile	28

Auto Start Page	29
PID Page	31
Control Page	32
Communication Page (optional)	33
Real Time Clock Page.....	33
Relay Outputs Page (optional)	34
Test Page	35
Zone Calibration Page.....	36
Sensor Calibration Page	38
Enable Page.....	40
Digital Inputs (optional).....	41
Error Messages and Alarms.....	42
Quick Reference and Default Values	43
Technical Specifications.....	50
MAINTENANCE	51
Checklist.....	51
Tests	52
Replacement	53
Parts	53
Protocol Plus™ Instrument	54
Heater Unit	54
Fan Motor	55
TROUBLESHOOTING	56
DRAWINGS	58
APPENDIX.....	65
Temperature Scale Conversion (C/F)	65
Optional MRC5000 Recorder Setup	66

INTRODUCTION

This section provides an overview of the Despatch RAD Series forced air oven. The RAD Series Ovens have the most effective heat distribution and the fastest processing time of any lab oven their size. Air is discharged from the right side wall of the oven and circulates through the chamber.

Special Features

The sturdy construction and three inch insulation of the Despatch RAD Series ovens contribute to excellent temperature uniformity.

Other special features include the following:

- Unique Despatch design to combine higher fan volume of forced recirculated air with a system of perforated stainless steel walls for the ultimate in temperature uniformity.
- Welded double wall construction and fiberglass insulation to reduce heat loss. Silicone rubber gaskets further minimize heat leakage.
- Rapid response heater.
- Scratch-resistant baked enamel exterior and stainless steel interior for easy cleaning.

Specifications

Dimensions

Model	Chamber Size in (cm)			Capacity feet ³ (liters)	Overall Size in (cm)			Maximum Number of Shelf Positions
	W	D	H		W	D	H	
RAD 1-42	20 (50)	18 (46)	20 (51)	4.2 (120)	46 (117)	31.75 (80.6)	37.25 (94.6)	9

Capacities

Model	RAD 1-42
Maximum Load	200 Lbs
Maximum Shelf Load	50 Lbs
Exhaust at 177°C (350°F)	Adjustable to 12 CFM
Recirculating Fan	400 CFM .5 HP
Approximate Weight Net	350 Lbs. 159 KG
Approximate Shipping Weight	480 Lbs. 218 KG

Temperature

Model		RAD 1-42-2E
Time to Temperature (approximate minutes with no load)	25°C - 100°C	6
	25°C - 200°C	21
	25°C - 343°C	56
Recovery Time Door Open 1 Min. (approximate minutes with no load)	100°C	<1
	200°C	3
	343°C	10
Temperature Uniformity at	100°C*	±1°C
	300°C*	±2°C
	343°C*	±3°C
Minimum Operating Temperature (Approximate w/20°C ambient)		40°C
Control Stability		±0.3°C
Repeatability		±0.5°C
Cooldown Time (approximate minutes with no load)	343 - 50°C damper open	108
	343 - 75°C damper closed	130

* Figures are based on actual tests in an empty oven. Uniformity can vary slightly depending on unit and operating conditions.

Power

Line voltages may vary in some geographical locations. If your line voltage is much lower than the oven voltage rating, warm up time will be longer and motors may overload or run hot. If your line voltage is higher than name plate rating, the motor may run hot and draw excessive amps.

If the line voltage varies more than 10% from the oven voltage rating, some electrical components such as relays, temperature controls, etc. may operate erratically.

Power Requirements

Model	Volts	Amps	Hertz	Phase	Heater KW
RAD 1-42	240/208*	29.7/26.4	50/60	1	6/4.5 *

* Oven designed for 240 volts (see name plate on oven) will operate satisfactorily on a minimum of 208 volts, but with a 25% reduction in heater power.

THEORY OF OPERATION

This section details the function and operation of assemblies and subassemblies on the Despatch RAD1-42-2E Ovens. These ovens have the most effective heat distribution system and the fastest processing time of any lab ovens their size. They are especially useful for testing, preheating, sterilizing, drying, aging and curing as well as other production applications. Horizontal airflow with precision digital control delivers uniform, fast processing. The overall result is efficient productivity under strenuous conditions.

The unique Despatch computerized design moves forced convected heat through perforated stainless steel walls. The air is recirculated with a high volume fan. The Despatch RAD1-42-2E oven employs a higher volume fan than any competitive model. The chamber can be densely loaded without interfering with the process. The RAD1-42-2E air delivery temperature is within 1/2°C of the number appearing on the digital display. Also, fresh air intake is regulated by a damper slide located on the left side of the oven. The exhaust opening is fixed on the RAD1-42-2E. The exhaust port, located on the back of the oven, is covered by a hat bracket. For safety reasons, do not remove the hat bracket.

Damper Control

The oven is equipped with a manually adjustable damper mechanism. The damper control arm is located on the left side of the oven. The damper adjustment controls the flow of fresh air into the chamber. If the damper is in the full open position, the maximum amount of fresh air is distributed into the chamber.

Determining Damper Settings

The optimum setting for the amount of fresh air that should be distributed into the chamber depends on several factors. These factors include ambient environment temperature, load conditions, load distribution, heat up rates, cool down rates, desired temperature uniformity and most importantly the desired operating temperature. To consider all of these variables at any one point in time is not practical and there are engineering tradeoffs that should be considered. Therefore guidelines should be used to determine the fresh air damper setting.

In general, the damper should be set so that the amount of fresh air flowing into the chamber agrees with the desired operating temperature conditions. The following outline shows the considerations involved with various damper position settings.

Full Closed Position

When the fresh air damper is in the full closed position, the chamber will be able to achieve the maximum attainable heat up rates for the chamber. In addition, the chamber will use the minimum amount of power to operate at the desired temperature. In almost all cases, the fresh air damper should be in the full closed position in order to efficiently operate at the maximum operating temperature for the chamber.

WARNING:

This oven is not designed for use with flammable material. If your process involves flammable material see the RFD series.

Full Open Position

When the fresh air damper is in the full open position, the chamber will operate at its minimum operating temperature.

Friction heat from the air recirculation system builds up in the chamber. This causes chamber temperature to rise slightly even though the heating system is not turned on. After the recirculation motor has been on for an extended period of time, the chamber will reach a thermal equilibrium temperature.

When the damper is not set to the full open position, the chamber has no way to readily dissipate the heat generated by the friction. With the fresh air damper fully open, the thermal equilibrium temperature is the minimum operating temperature of the chamber.

Other Damper Settings

The damper can be set to several other distinct operating positions. In most cases the damper setting is influenced by two specific performance factors. The two performance factors are uniformity and cool down rates.

The uniformity of the chamber is influenced by the inside chamber pressure of the system. The pressure inside the chamber is dependant on the amount of fresh air flowing into the chamber. When a large volume of fresh air is flowing into the chamber, the chamber becomes slightly pressurized and the overall temperature uniformity improves. The slightly pressurized chamber produces the effect of "pushing" the air to the corners of the chamber. Typically the corners of the chamber will improve with respect to temperature distribution while the core of the chamber will maintain excellent uniformity characteristics regardless of the damper position. Therefore, the pressurization of the chamber typically is a factor when the chamber is loaded heavily. The best uniformity results, with respect to the product, are achieved when no more than two-thirds of any inside chamber dimension are used. The best overall results are achieved when the product(s) are located in the center of the chamber.

NOTE: Overpressurizing the chamber can cause hot air to blow out around the door seal and cause the area around the door to be hot to the touch. To stop this hot air from entering the room, close the damper slightly until the air stops blowing.

OVEN INSTRUCTIONS

The INSTRUCTIONS section provides directions for unpacking, installation, operation and maintenance of the RAD1-42-2E oven.

Unpacking and Inspection

Remove all packing materials and thoroughly inspect the oven for damage of any kind that could have occurred during shipment.

- See whether the carton and plastic cover sheet inside carton are still in good condition.
- Look at all outside surfaces and corners of the oven for scratches and dents.
- Check the oven controls and indicators for normal movement, bent shafts, cracks, chips or missing parts such as knobs and lenses.
- Check the door and latch for smooth operation.

If there is damage that may have occurred during shipment, follow these instructions.

1. Contact the shipper immediately and file a written damage claim.
2. Contact Despatch Industries to report your findings and to order replacement parts for those that were damaged or missing.
3. Send a copy of your filed damage claims to Despatch.
4. Next, check to make sure you have received all the required materials. Your shipment should include:
 - One (1) Despatch oven
 - One (1) Instruction manual
 - One (1) Warranty card
 - Two (2) Shelves
5. If any of these items are missing from the packaged contents, contact Despatch Industries to have the appropriate materials forwarded to you.
6. Finally, to protect the warranty on your new RAD1-42-2E oven, complete the warranty card and mail it to Despatch within 15 days after receipt of the equipment.

Set-up

1. Select the location for installing your oven.
2. If required, an exhaust stack should be installed with the exhaust discharge stack to the outside of the building.

WARNING:

Do not use the oven in wet, corrosive or explosive atmospheres unless this oven is specifically designed for a special atmosphere.

- The exhaust opening is 2-1/2" diameter in the back of the oven.
- If an exhaust stack is used, a minimum area greater than the area of the exhaust stack is required.
- The flashing through the roof or wall must be capable of handling an exhaust stack temperature up to 343°C (650°F).
- All stacks must comply with state and local building codes to insure that surrounding combustible surfaces are below 71°C (160°F).
- Design the exhaust stack to limit the amount of restrictions to insure proper airflow. If more than two (2) elbows are used in the stack, over all airflow will be reduced.

3. Place oven on a bench top or an optional cabinet base, or directly on the floor.

The oven must have a minimum 2 inch clearance in the rear to provide proper ventilation. When placed next to another cabinet, or next to another oven, a 3 inch clearance is required. The doors will still open.

4. Make sure oven is level and plumb; this will assure proper heat distribution and operation of all mechanical components.
5. Identify correct power source indicated on the specification plate.

6. Hardwire the oven directly to the electric supply. The oven line connection is located on the equipment mounting panel.

WARNING:

All grounding and safety equipment must be in compliance with applicable codes, ordinances and accepted safe practices.

Operating

Users and operators of this oven must comply with operating procedures and training of operating personnel as required by the Occupational Safety and Health Act (OSHA) of 1970, Section 5 and relevant safety standards, and other safety rules and regulations of state and local governments. Refer to the relevant OSHA and National Fire Protection Association (NFPA) safety standards.

WARNING:

Do not use the oven in wet, corrosive or explosive atmospheres unless this oven is specifically designed for a special atmosphere.

Operating Environment

The Despatch oven is designed to operate in an industrial setting. Despatch does recommend the following environmental operating guidelines:

1. The oven is placed on a solid foundation.
2. The oven is not exposed to excessive external vibration.
3. All electrical cabinet covers must remain affixed.
4. Reasonable particulate matter in the atmosphere. Where excessive particulate matter is present, such as on a construction site or coal processing, Despatch recommends periodic (usually monthly) cleaning of all electrical compartments.
5. The power supply is within the specifications provided by Despatch. If the facility power supply is not stable, Despatch recommends a line conditioner.

Loading the Oven

Despatch Industries cannot be responsible for either the process or process temperature used, or for the quality of the product being processed. It is the responsibility of the purchaser and operator to see that the product undergoing processing in a Despatch oven is adequately protected from damage.

Carefully following the instructions in this manual will help the purchaser and operator in fulfilling that responsibility.

When loading the oven avoid spills of anything onto the heater elements or onto the floor of the oven. Do not place the load on the oven floor plate. This may cause the load to heat unevenly and the weight may cause shorting out of the heater elements. Use the shelves provided.

WARNING:

Do not use flammable solvent or other flammable material in this oven. Do not process closed containers of any substance in this oven because they may explode under heat.

The two shelves are designed to be pulled out about half way without tipping. The support capacity of the shelves is listed in the Capacities Table in the Specifications section in this manual. Do not overload the shelves.

Distribute the workload evenly so that airflow is not restricted. Do not overfill your oven. The workload should not take up more than two-thirds of any dimension of the inside cavity.

Pre-Startup Checklist

- Know the system. Read this manual carefully. Make use of its instructions and explanations. Safe, continuous, satisfactory, trouble-free operation depends primarily on the degree of your understanding of the system and your willingness to keep all parts in proper operating condition.
- Check line voltage. Voltage must correspond to nameplate requirements of motors and controls. Refer to the section on power connections in the INTRODUCTION of this manual.
- Fresh air and exhaust. Do not be careless about restrictions in and around the fresh air and exhaust openings and stacks. Under no condition permit them to become so filled with dirt that they appreciably reduce the air quantity. The proper ventilation clearances should be fulfilled at all times. Refer to the Set-up instructions in this manual.
- Helpful hints

For drying ovens, open vent to prevent buildup of moisture.

For sample heating, close the vent when no ventilation is required.

Startup

For fastest oven heat-up time, close the fresh-air vent. After the desired temperature is reached, the vent may be adjusted as needed.

1. Start Fan.
 - a. Open oven door.
 - b. Press Power switch to the On position. You will hear the recirculating fan start.
 - c. Shut oven door.
 - d. Check that the control display turns on.
2. Operate the temperature control as desired by following the control operation instructions that follow.

CONTROL

The special features of the Protocol Plus™ control include:

- PID tuning
- Ramp/Soak programming of up to 64 segments
- Segment looping and profile linking
- Built-in manual reset high limit control
- Built-in process timer
- Dedicated LED display for process temperature
- Multi-purpose two-line LCD display with backlight
- Auto-tuning
- Security access
- Process temperature retransmission signal
- Digital inputs for remote profile control
- Real time clock
- Optional relay outputs for events, alarms, or end-of-cycle signal
- Optional RS232/RS422/RS485 MODBUS communications

Theory of Control Operation

The Protocol Plus is a modular microprocessor based digital temperature controller. The Protocol Plus operates as a dual functioning controller/high limit instrument. The control portion utilizes a time-proportioning voltage signal to control heating devices with minimal temperature fluctuations.

The high limit portion protects the product and/or the oven from overheating. If the product being processed has a critical high temperature limit, the high limit setpoint should be set to a temperature somewhat below the temperature at which the product could be damaged. If the product does not have a critical high temperature limit, the high limit setpoint should be set 5 to 15 degrees higher than the maximum programmed setpoint at which the oven will operate.

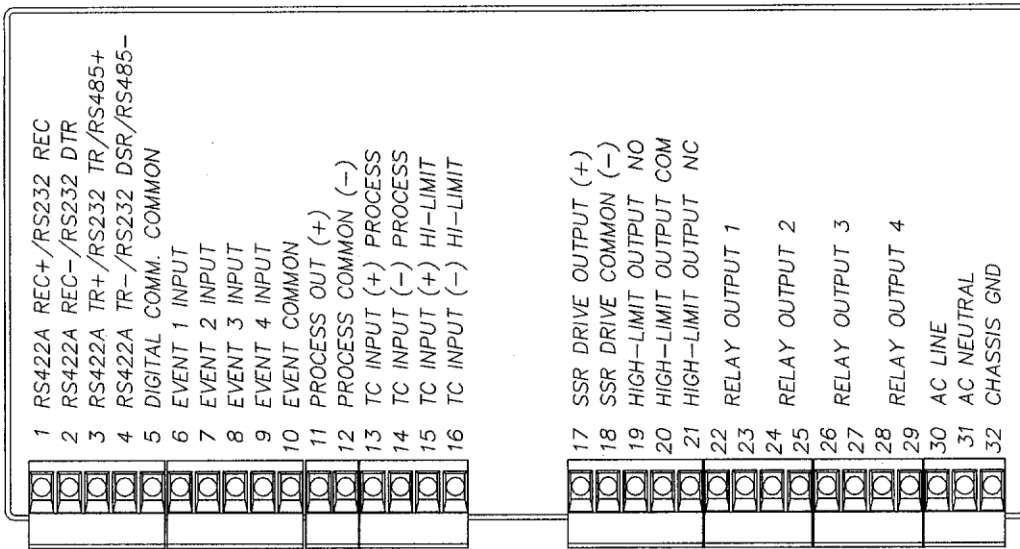
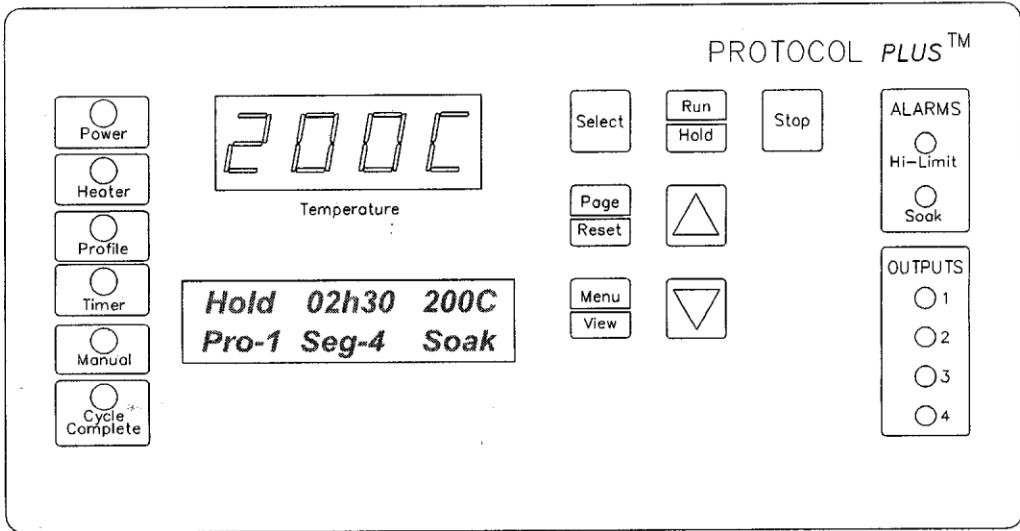

Protocol Plus Faceplate and Wiring Diagram

Operating Modes

The Protocol Plus control has five modes of operation available:

- Stopped Mode:** All control and relay outputs are off. Stopped Mode is integrated into each of the following four modes of operation.
- Manual Mode:** Control operates as a single setpoint control until Stopped mode is accessed
- Timer Mode:** Control operates as a single setpoint control until preset time period has expired.
- Profile Mode:** Control operates as a ramp/soak profiling control until the end of the profile. 8 profiles are available with up to 8 ramp/soak segments in each profile.
- Auto Start Mode:** Control may automatically start Manual, Timer, or Profile mode based on a preset time and day.

The optional event outputs can be utilized during Manual, Timer, or Profile modes.

Setup Mode

The control has a Setup Mode which provides access to control configuration and programming of profiles. The Setup Mode contains ten separate electronic Pages where the configuration and programming parameters (Menu items) are found. The Setup Mode Pages are described in detail elsewhere in this manual.

Fast Start Mode

The Protocol Plus control has the ability to automatically start an operating mode when power is applied. This feature may be useful if the same mode of operation is used everyday. The user can turn on the power and the oven will start the desired process automatically. The Fast Start Mode is controlled by the Power-Up Start parameters on the Control page (see Setup Mode).

High Limit

The control has an integrated high limit function which will disable the heater output when tripped. If the high limit does trip, the relay will need to be manually reset. When the high limit relay is tripped, the Hi-Limit indicator will be lit. Allow the oven to cool several degrees (or increase the high limit setpoint) and then press the Reset key. The indicator will turn off.

High-Limit temperature readout is provided on LCD Line #2 in all Modes (Stop, Run, Hold, and Standby) except Setup Mode. High-Limit temperature is displayed for 10 seconds, alternating with current Mode and Status display for 10 seconds.

The control will not allow the high limit setpoint to be set below the current setpoint value.

Indicators

The Protocol Plus control has 12 indicating LEDs that provide operational information to the user.

- **Power LED:** Indicates that power is supplied to the instrument.
- **Heater LED:** Indicates that the heater output is active.
- **Profile LED:** Indicates that the Profile Mode is in operation.
- **Timer LED:** Indicates that the Timer Mode is in operation.
- **Manual LED:** Indicates that the Manual Mode is in operation.
- **Cycle Complete LED:** Indicates that the control is in Stopped mode.
- **Hi-Limit Alarm LED:** Indicates that the high limit relay has tripped (de-energized).
- **Soak Alarm LED:** Indicates that the guaranteed soak deviation is in alarm condition.
- **Outputs 1 through 4:** Indicate that the optional relay outputs are in the ON state. These outputs may be configured as timed event outputs, process temperature trip point outputs, alarm outputs, or as an end of cycle relay output. The ON state can be configured as energized or de-energized.

Displays

The Protocol Plus control has two displays. A dedicated LED upper display shows the oven temperature. A two-line LCD lower display provides information on control status, high limit temperature, and allows changes to be made to the control settings.

Key Functions

The Protocol Plus control has seven keys that provide operation.

- **Select key:** Press to select mode of operation. In Setup Mode, to select profile number or relay. In Profile/Run Mode, press simultaneously with the UP key to advance a segment.
- **Run/Hold key:** Press to activate a mode of operation. If a Profile (or Timer) Mode is running, pressing the Run/Hold key will place the Profile (or Timer) in Hold status. A subsequent press will resume the Profile (Timer).
- **Stop key:** Press to stop any mode of operation.
- **Page/Reset key:** While in Setup Mode, press to access different Pages of configuration, Press this key to silence an alarm if the instrument alarm sounds during operation. In an operating mode, if an alarm or error condition occurs, press this key to return the instrument to normal operation once the condition is cleared.
- **Menu/View key:** While running any operating mode, pressing this key will display the high limit setpoint. While in Setup Mode, pressing this key will provide access to each Menu parameter.
- **▲▼ keys:** Press these keys to adjust parameter settings. In Profile/Stopped Mode, press to select profile to run. In Profile/Run Mode, press ▲ key simultaneously with the Select key to force the program to advance one segment.

Outputs

The Protocol Plus control has seven different outputs available.

- Heating output:** The control output is a DC voltage open-collector output which is time-proportioned and designed to control a heat control device such as a solid state relay.
- High limit:** The high limit output is a form C relay which is energized under normal operating conditions. If the control senses a temperature higher than the high limit setpoint, or if there is a sensor error, the high limit relay will de-energize until the condition is cleared and the Reset key is pressed. When the high limit relay is de-energized, the heater is disabled.
- Retransmission:** The retransmission output is a DC 1 to 5 volt or 4 to 20 ma (DC) signal that is proportional to the process temperature. The signal can be an input to other devices such as a chart recorder.
- Relay (four optional outputs):** The four form A dry contact relay outputs can be configured to function as alarms, events, or end of cycle. These outputs can be utilized in Manual, Timer, or Profile Mode.

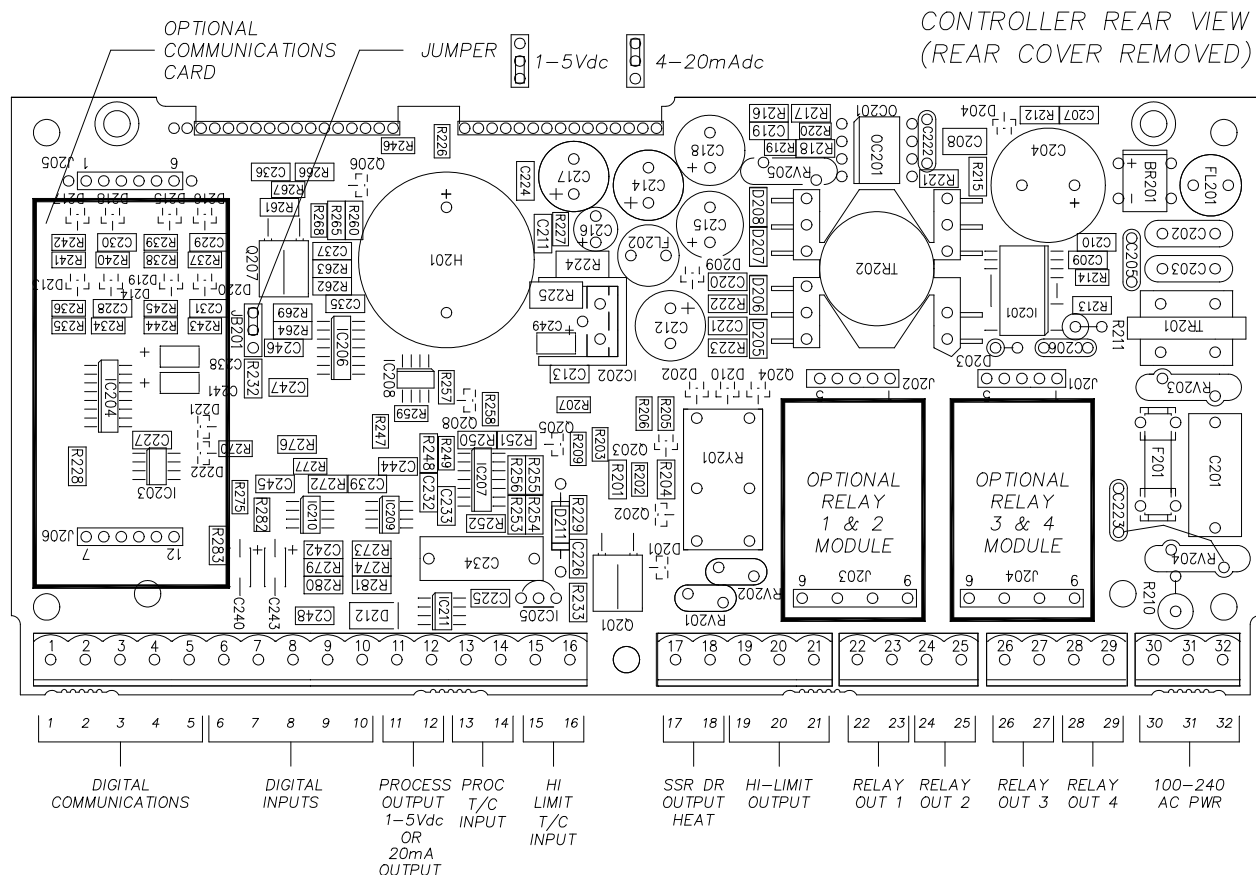

Layout for Optional Components

Relay (Continued)

Use the Relay Card Optional Ay p/n 144562 to add relays to the standard controller. Each relay card contains two relays (maximum of two cards Ay's allowed).

Communication

The Protocol Plus control has optional MODBUS communication available which can communicate via RS232, RS422, or RS485 to a computer. See communications option assembly p/n 161957 for board and cable assembly. Please refer to the MODBUS communications manual which comes with this option.

Optional Software

The Protocol Manager program allows the operator to start/stop multiple ovens (32 maximum) from a personal computer. A data log can also be used to record process information (p.n. 140008).

INSTRUCTIONS

Start-Up

These instructions are provided as a quick reference for operating the Protocol Plus control. If the Profile Mode is to be used, or the configuration of the control needs to be changed, please refer to the Setup Mode instructions before operating the control. For more detailed operating instructions refer to the Operation instructions for the mode you wish to use.

Upon initial power-up the control is in Manual/Stopped Mode (unless the Autostart or Fast Start Modes are active). To activate any operating mode from Stopped Mode, press the Select key until the desired mode is displayed, then press the Run key. If the proper Profile number is not displayed when the Profile Mode is accessed, press the ▲ or ▼ keys until the desired Profile number is displayed, then press the Run key. If no profile numbers can be displayed (display only reads NONE) then no profiles are currently programmed (see Setup Mode).

The Hi-limit thermocouple actual temperature reading is displayed, when the lower LCD display reads **HL Temp**. Note: This is not a error message.

The temperature setpoint can be adjusted while Manual or Timer Mode is running by pressing the UP or DOWN key.

To momentarily hold the Timer or Profile Mode, press the Hold key. To continue the Timer or Profile Mode, press the Run key.

To return to Stopped Mode at any time, press the Stop key and the cycle complete LED will illuminate.

Note that the control can be configured to automatically activate Manual, Timer or Profile Mode when power is applied (power switch turned on). See Control Page in the Setup Mode to utilize the Fast Start mode.

Operation

Manual Mode

Press the Select key until Manual is displayed (note you can press the Run key at any time to activate Manual Mode).

1. Press the Menu key to display the Process Temperature Setpoint (setpt). You can change the Setpoint with the ▲▼ keys.

Note: If the SPChange parameter on the Enable page in Setup Mode has been set to DISABLED, it must be changed to ENABLED before any changes to the process temperature and high limit setpoints can be made.

2. Press the Menu key a second time to display current high limit setpoint (Hi-Lim SP). The value can be adjusted by pressing the ▲▼ keys. If **Band** is displayed, the high limit band feature is activated (see Control page) and the high limit can not be adjusted.
3. (optional feature) Press the Menu key a third time to display Event1. Press the ▲ key to turn on the event or ▼ to turn off the event. Repeat for all events which are enabled (up to 4).
4. To start Manual Mode, press the Run key.

The display will change from Stop to Run. To return to Stopped Mode, press the Stop key. While in operation, the process setpoint can be adjusted by using the ▲▼ keys to change the value while the mode is running. Pressing the Menu key will display the High Limit Setpoint (HLSP) setting.

If changes to the high limit setpoint or event output configuration are needed, they must be done from the stopped mode.

Timer Mode

1. Press the Select key until Timer is displayed (note you can press the Run key at any time to activate Timer Mode).
2. Press the Menu key to display the Process Temperature Setpoint (Setpt). You can change the Setpoint with the ▲▼ keys.

Note that if the SPChange parameter on the Enable page in Setup Mode has been set to DISABLED, it must be changed to ENABLED before any changes to the process temperature and high limit setpoints can be made.

3. Press the Menu key a second time to display current high limit setpoint (Hi-lim SP). The value can be adjusted by pressing the ▲▼ keys. If **Band** is displayed, the high limit band feature is activated (see Control page) and the high limit can not be adjusted.
4. Press the Menu key a third time to display Time Set. You can change the time setting with the ▲▼ keys.
5. (optional feature) Press the Menu key a fourth time to display Event1. Press the ▲ key to turn on the event or ▼ to turn off the event. Repeat for all events which are enabled (up to 4).
6. Press the Menu key a fifth time to display the current guaranteed soak band (TmrGuarSoak) value. If the process temperature deviates from the setpoint by more than this value, the timer is placed in a hold condition. The timer continues when the process temperature falls within range. Reference the Quick Reference and Default Values section for available settings.
7. To start Timer Mode, press the Run key.

The display will change from Stop to Run and the time remaining will be displayed. To return to Stopped Mode, press the Stop key. While in operation, the process setpoint can be adjusted by using the ▲▼ keys to change the value while the mode is running. Pressing the Menu key will display the High Limit Setpoint.

Pressing the Run/Hold key while the Timer Mode is in operation will put the control in Hold status. The Timer LED will flash to indicate the held status. Press the Run/Hold key again to continue timing. The Timer LED will return to lit status.

Profile Mode

1. Press the Select key until Profile is displayed. "None" may be displayed if a profile has not been selected or no profiles entered.
2. Press the ▲▼ key to display the desired profile to run.
3. To start Profile Mode, press the Run key.

The display will change from Stop to Run and the segment time remaining, Temperature Setpoint, Profile #, along with the current segment number, will be displayed. To return to Stopped Mode, press the Stop key.

Pressing the Run/Hold key while the Profile Mode is in operation will put the control in Hold status. Press the Run/Hold key again to continue the mode. The Profile LED will flash to indicate the hold status.

To advance to the next segment while running a profile, press the Select and UP arrow keys at the same time.

If **Link To** is set to **Standby** in the Program Page, at the End of Program/Profile,

1. Cycle Complete LED indication goes ON.
2. Controller beeps if **End of Cycle** beep is enabled.
3. Heater/control output keeps controlling oven temperature at last Soak setpoint.
4. All events programmed (if relay cards installed and programmed as an event) for the last Soak Segment stays active.

Note that ramping down too fast may cause the high limit relay to trip unexpectedly if the high limit band feature is used. This can be avoided by using a separate cooling profile that does not utilize the high limit band and then jumping to that profile to perform rapid cooling.

Auto Start Mode

The Auto Start Mode allows the control to start Manual, Timer, or Profile mode automatically at a preset time and day. See the Auto Start Page in Setup Mode for the time, day, and operating mode settings.

To activate the Auto Start Mode,

1. On Auto Start page, **Enable** is set to **Yes**.
2. LCD reads **Active** on line 1 in Auto Start Mode.
3. On Auto Start page **Enable** set to **No**, will deactivate Auto Start Mode.

Note that once you activate Auto Start, you can continue to use all operating modes as normal. If an operating mode is running at the time of a preset Auto Start function, and Auto Start is activated, the existing operating mode will override the auto Start function and the Auto Start will not turn on.

Note: All process Set to Run in Auto Start Mode must be at least one minute long for all Run Modes (Manual, Timer, and Profile).

Setup Mode

Configuration of the control and programming of the ramp/soak profiles must be done in the Setup Mode. To access Setup Mode, the control must first be in Stopped Mode.

1. Press the Select key until Setup is displayed.
2. Press the Page key and Security will be displayed.
3. Press the Menu key and Password will also be displayed. Use the ▲▼ keys to enter the proper password.
4. Once the proper password is displayed, press the Page key twice to enter the Setup Mode.

To exit Setup Mode, press and hold the Page key for three seconds.

The control has two levels of password-protected security. Level one provides access only to those menu pages that are enabled on the Enable page. Level two provides access to all menu pages, including the Enable page. The default security password values are 1 for level one and 2 for level two.

If an improper password has been entered, the control will remain at the Security display. To enter the proper password, press the Menu key. To exit Setup Mode, press and hold the Page key for three seconds.

Mapping of the Setup Mode is provided in the following sections. To access each parameter Page, which are described in detail in the following sections, press the Page key until the desired page heading is displayed. Press the Menu key to access each Menu parameter. Press the ▲▼ keys to change Menu parameter settings.

Refer to the Quick Reference and Default Values section for available settings for each Menu parameter.

Press the Page key to continue with each Page, or press and hold the Page key for three seconds to exit Setup Mode.

Instructions for Setup Mode Pages

Program Page

Programming of the profiles is provided on the Program Page. Eight profiles are available with up to eight ramp and soak segments per profile.

If the optional relay outputs are installed, they must be configured as alarms or events on the Relay Outputs Page before they can be utilized. If configured as event outputs, these relays can be used as time or temperature events.

When entering the Program Page, press the Select key to select the profile you wish to enter/edit, then press the Menu key. The first parameter (Profile #, Segment 1, Ramp Time) will display. Adjust the time value with the ▲▼ keys. Once the proper value is displayed, press the Menu key to continue. Continue with the Menu key to adjust/view each parameter.

If the ramp time value of the current segment is left at 0:00, the next press of the Menu key will advance the control to the High Limit Setpoint parameter for that profile. Continue entering / verifying all parameters until you get to the last parameter (Guaranteed Soak Band). Once all parameters have been properly entered, press the Page key to return to the top of the Profile Page. You can press the Select key to enter/edit another profile, press the Page key to access another page, or press and hold the Page key to exit Setup mode.

While editing any profile, pressing the Select key will advance the control to the time value for the next segment, until the last segment has been reached. This allows faster editing of the profile rather than pressing the Menu key to advance past each parameter.

If **Link To** is set to **Standby** in the Program Page, at the End of Program/Profile,

1. Cycle Complete LED indication goes ON.
2. Controller beeps if **End of Cycle** beep is enabled.
3. Heater/control output keeps controlling oven temperature at last Soak setpoint.
4. All events programmed (if relay cards installed and programmed as an event) for the last Soak Segment stays active.

To run a profile indefinitely, link the profile to itself.

Menu Item	Display	Description
Ramp Time Seg 1	Pro-1 Seg-1 Ramp Time	Ramp time for segment 1 of profile
Event 1 Set Value*	Pro-1 Seg-1 Ramp Event 1	Event 1 setting for segment 1 ramp of profile
Event 2 Set Value*	Pro-1 Seg-1 Ramp Event 2	Event 2 setting for segment 1 ramp of profile
Event 3 Set Value*	Pro-1 Seg-1 Ramp Event 3	Event 3 setting for segment 1 ramp of profile
Event 4 Set Value*	Pro-1 Seg-1 Ramp Event 4	Event 4 setting for segment 1 ramp of profile
Soak Temp Seg 1	Pro-1 Seg 1 Soak Temp	Soak temperature for segment 1 of profile
Soak Time Seg 1	Pro-1 Seg 1 Soak Time	Soak time for segment 1 of profile
Event 1 Set Value*	Pro-1 Seg-1 Soak Event 1	Event 1 setting for segment 1 soak of profile
Event 2 Set Value*	Pro-1 Seg-1 Soak Event 2	Event 2 setting for segment 1 soak of profile
Event 3 Set Value*	Pro-1 Seg-1 Soak Event 3	Event 3 setting for segment 1 soak of profile
Event 4 Set Value*	Pro-1 Seg-1 Soak Event 4	Event 4 setting for segment 1 soak of profile
(repeat for segments 2-8, until ramp or soak time = 00:00)		
High Limit Setpoint	Pro-1 Hi-Lim SP	High limit setpoint for profile**
Loop From	Pro-1 Loop From Seg	To start a loop action in a profile
Loop To	Pro-1 Loop To Seg	To end a loop action in a profile
Loop Count	Pro-1 Loop Number	Number of times to execute loop
Profile Link	Pro-1 Link To Pro	To jump from this profile to another
Guaranteed Soak	Pro-1 Guar Band	Guaranteed soak band for profile

See the definitions on the following pages for parameter ranges.

* only available if optional relay outputs are installed (repeat all for profiles 2-8)

** Set to **Band** to use the high limit band feature

Profile #	There are eight profiles available.
Segment#	Recipe segments 1 through 8 may be programmed, each with its own set of events, ramp and soak times, and soak temperature.
Ramp Time	The time required to ramp from one setpoint up to another setpoint. Values between 0 and 99:59 are allowable. In the Protocol Plus controller, the profile ramp and soak times are stored without units. Units are set as either hours and minutes (HH:MM) or minutes and seconds (MM:SS). The setpoint will automatically increment from the actual temperature to the soak temperature.
EV1 through 4	From 1 to 4 events may be programmed into the ramp time portion of each segment here. These typically involve actuating/disabling relays to close/open valves or perform other relay-controlled functions. NOTE: These will only actuate when the controller has the relay cards installed and programmed for an event.
Soak Temp.	The temperature setpoint of a particular segment is entered here; it can range from -18 to 540 degrees C (0 to 1000 degrees F).
Soak Time	The duration of soak is entered here; the value can range from 0 to 99:59.
EV1 through 4	From 1 to 4 events may be programmed into the soak portion of each segment here. These typically involve actuating/disabling relays to close/open valves or perform other relay-controlled functions. NOTE: These will only actuate when the controller has the relay cards installed and programmed for an event.
Hi Limit SP	The high limit setpoint may be entered here; if the temperature exceeds this value, the hi-limit will alarm and shut off the heater.
Loop From	Values are No, Seg-1 to Seg-8.
Loop To	Values are No, Seg-1 to Seg-8.
Loop Number	Values are 0 - 99. These values enable the operator to jump from a certain step to another step of the recipe a preset number of times.
Profile Link	Values are STANDBY/STOP/HOLD/1 - 8. When the profile ends, the profile can hold the temperature setpoint while keeping the events active, turn the heater off, hold the temperature setpoint at the end of the profile, or jump to another specified profile.
Guaranteed Soak Band	If the process temperature deviates from the setpoint by more than this value, the soak timer is placed in a hold condition. The timer continues when the process temperature falls within range.

Sample Profile

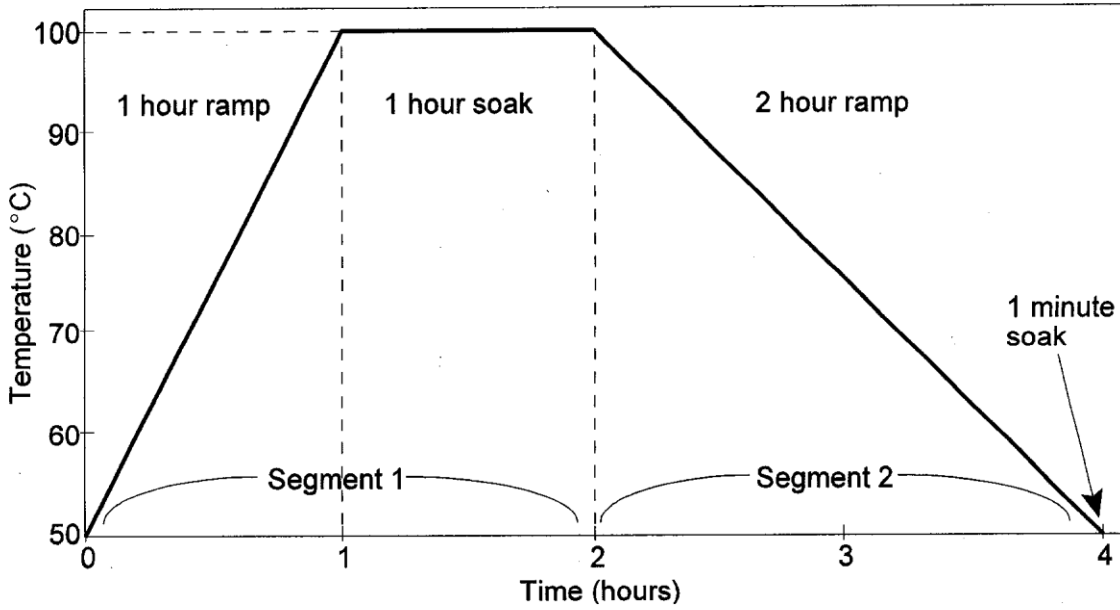

Programming Table

Profile Number 1

Profile Name _____

Segment	Time	Ramp				Temperature	Time	Soak			
		Events						Events			
		1	2	3	4			1	2	3	4
1	01h00					100	01h00				
2	02h00					50	00h01				
3	00h00										
4											
5											
6											
7											
8											

High Limit Setpoint	115
Loop From Seg	No
Loop To Seg	No
Loop Number	0
Link To Pro	No
Guar Soak Band	10

Auto Start Page

The Auto Start Page can be configured to automatically start Manual, Timer or Profile Mode at a specified time and day. Note that if Auto Start Enable is set to Yes in the Setup Mode, the Auto Start feature is not turned on - it is available to the operator to be activated in Stopped Mode.

To configure the Auto Start feature:

1. Access the Setup Mode.
2. Press the Page key until Auto Start is displayed.
3. Press the Menu key. If there is no change in the display, the controller may not have the realtime clock option.
4. Set Auto Start Enable to Yes.
5. Using the Menu key, scroll through the options available and use the ▲▼ keys to set the mode desired for each day of the week. You may select from Manual, Timer, or Profile 1 through 8.
6. When the mode is set press the Menu key.
7. Enter the time of day you wish the mode to activate.
8. Continue through the rest of the week by pressing the Menu key, or press the Page key when done.

One Auto Start mode can be set for each day of the week. Exit the Setup mode by pressing and holding the Page key for three seconds. Press the Select key until Auto Start is displayed. Make sure the correct time and day is displayed. If not proper, set it to the correct time on the Real Time Clock Page in the Setup mode.

To activate the Auto Start Mode,

1. On Auto Start page, **Enable** is set to **Yes**.
2. LCD reads **Active** on Line 1 in Auto Start Mode.
3. On Auto Start page **Enable** set to **No**, will deactivate Auto Start Mode.

Note that once you activate Auto Start, you can continue to use all operating modes as normal. If an operating mode is running at the time of a preset Auto Start function, and Auto Start is activated, the existing operating mode will override the Auto Start function and the Auto Start will not turn on.

Note: All process Set to Run in Auto Start Mode must be at least one minute long for all Run Modes (Manual, Timer, and Profile).

Menu Item	Display	Description	Range
Enable Autostart	Auto Start Enable	Enable (yes) or disable (no) the Autostart function	No, Yes
Sunday mode	Auto Start Sun Mode	Set mode on Sunday to activate	Off, Manual, Timer, Pro-1 to Pro-8
Sunday time	Auto Start Sun Time	Set time on Sunday for mode to activate	00:00 to 23:59
Monday mode	Auto Start Mon Mode	Set mode on Monday to activate	Off, Manual, Timer, Pro-1 to Pro-8
Monday time	Auto Start Mon Time	Set time on Monday for mode to activate	00:00 to 23:59
Tuesday mode	Auto Start Tue Mode	Set mode on Tuesday to activate	Off, Manual, Timer, Pro-1 to Pro-8
Tuesday time	Auto Start Tue Time	Set time on Tuesday for mode to activate	00:00 to 23:59
Wednesday mode	Auto Start Wed Mode	Set mode on Wednesday to activate	Off, Manual, Timer, Pro-1 to Pro-8
Wednesday time	Auto Start Wed Time	Set time on Wednesday for mode to activate	00:00 to 23:59
Thursday mode	Auto Start Thu Mode	Set mode on Thursday to activate	Off, Manual, Timer, Pro-1 to Pro-8
Thursday time	Auto Start Thu Time	Set time on Thursday for mode to activate	00:00 to 23:59
Friday mode	Auto Start Fri Mode	Set mode on Friday to activate	Off, Manual, Timer, Pro-1 to Pro-8
Friday time	Auto Start Fri Time	Set time on Friday for mode to activate	00:00 to 23:59
Saturday mode	Auto Start Sat Mode	Set mode on Saturday to activate	Off, Manual, Timer, Pro-1 to Pro-8
Saturday time	Auto Start Sat Time	Set time on Saturday for mode to activate	00:00 to 23:59

PID Page

The PID Page contains parameters which control the response to the setpoint and process variable input. To access the PID Page, enter the Setup Mode. Press the Page key until PID is displayed. Press the Menu key. Each parameter can be changed by pressing the Menu key until the desired parameter is displayed, and then pressing the ▲▼ keys to change the value.

Menu Item	Display	Description	Range
Display units	PID Temp Unit	Set display units to °C or °F	°C or °F
Proportional band	PID Prop Band	Set proportional band for tuning	1 to 56°C (1 to 100°F)
Integral reset	PID Reset/Rep/Min	Set integral reset for tuning	0.0 to 100 seconds/repeat
Derivative Rate	PID Rate In Sec	Set derivative rate for tuning	0.0 to 500 seconds
AutoTune	PID AutoTune	Enable auto tuning function	Disable, Enable

The AutoTune parameter disables or enables the AutoTune function. To utilize AutoTuning:

1. Access the Setup Mode.
2. Press the Page key until the display reads AutoTune. Press the ▲ key to enable the AutoTune.
3. Press the Page key for three seconds to exit Setup Mode.
4. Cycle power to the instrument.
5. Set Manual Mode to run. The display will alternately display AutoTune and Manual.

If the Manual Mode setpoint is less than 50 degrees higher than the actual process temperature, the AutoTune function will create an error condition. This can be cleared by either cooling off the process temperature or increasing the setpoint until there is more than 50 degrees between them. Once the AutoTune function is allowed to complete tuning, the AutoTune parameter will disable by itself.

If you wish to cancel the AutoTune function, press the STOP key, access the PID page in Setup Mode, and set the AutoTune parameter to Disable.

Control Page

The Control Page contains various parameters which control miscellaneous functions. To access the Control Page, enter the Setup Mode. Press the Page key until Control is displayed. Press the Menu key. Each parameter can be changed by pressing the Menu key until the desired parameter is displayed, and then pressing the ▲▼ keys to change the value.

Menu Item	Display	Description	Range
Cycle Time	Control Cycle Time Sec	Set cycle time in seconds for control output	1 to 60 seconds
High limit setpoint	Control Hi-Lim SP***	Maximum value for all high limit setpoints	MinHiLimSP - MaxHiLimSP*
High limit band	Control Hi-Lim Band	If=0, high limit setpoint= Control Hi-Lim SP If>0, high limit setpoint= Control SP* + Band	Off, 3°C to 11°C (5°F to 20°F)
Power fail recovery	Control PwrFRec	Controls response to loss of power	Stop, Restart, Hold, Resume
Recovery time limit	Control PFRTIME	Control aborts to Stopped mode if power is lost for time period longer then set value	00m00s to 99m59s
Powerup start enable	ControlPwrUpStrt	Allows mode to automatically start when power is first applied	Disable, Enable
Powerup Start Mode	Control StrtMode	Operating mode for powerup start	Off, Manual, Timer, Pro-1 to Pro-8
Hysteresis	Control Hysteresis	Hysteresis for all alarms and temperature events	1°C to 56°C (1°F to 100°F)
Process out low	Control RetOutLo	Process value for retransmit output = 1VDC	-73°C to 760°C (-100°F to 1400°F)
Process out high	Control RetOutHi	Process value for retransmit output = 5VDC	-73°C to 760°C (-100°F to 1400°F)
Time scale	Control TimeScale	Time scale setting for program and timer mode**	hh:mm or mm:ss
Key press beep	Control KeyBeep	Internal beeper sounds when key is pressed	On or Off
End of cycle beep	Control EOCSBeep	Internal beeper sounds at end of cycle	On or Off
Alarm beep	Control AlarmBeep	Internal beeper sounds for alarms	On or Off

* includes ramping setpoints during profiles and controlled ramps

** power fail recovery time limit is always MM:SS regardless of time scale setting

*** high limit setpoint is a read-only item which is calculated on Enable page

Communication Page (optional)

The Communication Page contains parameters for the communications feature. To access the Communications Page, enter the Setup Mode (see description earlier in this manual). Press the Page key until Communication is displayed. Press the Menu key. (NOTE: If there is no change in the display, the controller does not have the communications board installed.) Each parameter can be changed by pressing the Menu key until the desired parameter is displayed, and then pressing the ▲▼ keys to change the value.

Menu Item	Display	Description	Range
Address	Communication CommAddr	Sets address node for control	1 to 247
Mode	Communication Mode	Turns on/off communications	OFF, Modbus
Baud Rate	Communication BaudRate	Sets interface speed	2400, 4800, 9600, 19.2K, 38.4K
Parity	Communication Parity	Sets parity for interface	None, Odd, Even

Real Time Clock Page

The Real Time Clock Page allows the control to be configured to have an operating mode begin automatically at a specific time on a specific day of the week. The real time clock feature is also used for using the Power Failure Recovery mode Time Limit feature (see Control Page). The real time clock is a seven day, 24 hour clock with battery backup.

To access the Real Time Clock Page, enter the Setup Mode. Press the Page key until Clock is displayed. Press the Menu key. Each parameter can be changed by pressing the Menu key until the desired parameter is displayed, and then pressing the ▲▼ keys to change the value.

Menu Item	Display	Description	Range
Day of the week	Clock Day	Setting for current day of the week	Sun, Mon, Tue, Wed, Thu, Fri, Sat
Time of day	Clock HH:MM	Setting for current time of the day	00:00 to 23:59
Reset clock	Clock UP to Reset CLK*	Press the ▲ key to set the clock to entered values	Ready, Done

* If the ▲ key is not pressed, the clock values will retain their original values. The display will change to Done if the clock is reset

Relay Outputs Page (optional)

The Relay Outputs Page configures the four alarm/event outputs. Each output has a dedicated indicator light and can be configured as a temperature alarm, profile event, or end of cycle output. Temperature alarms can be of type process high, process low, deviation high, deviation low, or deviation band.

To access the Relay Page, enter the Setup Mode (see description earlier in this manual). Press the Page key until Relay is displayed. Press the Select key until the desired relay output is selected. Press the Menu key. Each parameter can be changed by pressing the Menu key until the desired parameter is displayed, and then pressing the ▲▼ keys to change the value. To configure a specific relay, press the Select key until the desired relay appears.

NOTE: If Relay 0 appears, then no relays are installed (see relay kit assembly p.n. 144562).

Menu Item	Display	Description	Range
Type of relay	Relay 1 RelayType	Set function of relay	Off, Alarm, Cycl, Ev1 to Ev4
Action of relay	Relay 1 RelayAction	Set coil and contact state of relay	NDE, NE, NDEL, NEL****
Type of alarm*	Relay 1 AlarmType	Set alarm type for relay	High, Low, Plus, Minus, Band
Alarm setpoint*	Relay 1 AlmHi/Lo SP	Setpoint for alarm	-73°C to 760°C (-100°F to 1400°F)
Alarm deviation*	Relay 1 AlmDevBand	Deviation band for alarm	1 to 56°C (1 to 100°F)
Inhibit alarm*	Relay 1 ALMInhibit	Inhibits alarm until "safe" condition is reached	En or Dis
Type of event**	Relay 1 EventType	Set event type for relay	Time or Temp
Event setpoint***	Relay 1 Event SP	Setpoint for temperature event	SPLoLim to SPUpLim****

(repeat for relay outputs 2-4, if available)

* appears only for alarm types

** appears only for time or temperature event types

*** appears only for temperature event types

Turning on the Alarm Inhibit function disables the alarm output on power up until the process temperature has reached a non-alarming condition ("safe").

If the relay output has been configured as latching, the RESET key must be pressed to return the output to the non-alarm state once the alarm condition has cleared.

Test Page

The Test Page contains parameters which allow manual control of the heat control and optional relay outputs and should be used only for testing the functionality of the control instrument. Do not operate the oven for processes using the Test Page.

To access the Test Page, enter the Setup Mode (see description earlier in this manual). Press the Page key until Test is displayed. Press the Menu key. Each parameter can be changed by pressing the Menu key until the desired parameter is displayed, and then pressing the ▲▼ keys to change the value.

Menu Item	Display	Description	Range
Heater output	Test HeatOut	Activate SSR output 100%	On
High limit relay	Test HiLimOut	Activate high limit alarm (de-energize relay)	On
Relay 1 output	Test Rly1 Out	Energize relay output 1	On
Relay 2 output	Test Rly2 Out	Energize relay output 2	On
Relay 3 output	Test Rly3 Out	Energize relay output 3	On
Relay 4 output	Test Rly4 Out	Energize relay output 4	On
HiLim Sensor	Test HL Temp (push and hold up)	Displays sensor reading*	

*Push ▲ key to refresh display

When the Test Page is entered, all outputs are automatically set to off. When exiting the Test Page, all outputs will return to their previous condition regardless of the Test Page settings.

Zone Calibration Page

The Zone Calibration Page allows adjustment of the displayed temperature versus the actual temperature measured by the control thermocouple. This may be desirable in certain conditions where the center of the oven chamber is not the same temperature as the control thermocouple. This may occur when the oven is not allowed to soak at a constant temperature for long periods of time, or the oven is being used at high temperature.

There is also a Factory Calibration Recovery which will restore the factory calibration values when the control was first shipped by the manufacturer. This may be helpful if the calibration has been lost and a calibration instrument is not readily available. To use the Factory Calibration Recovery feature only, bypass the Zone 1 and Zone 2 calibration parameters by pressing the Menu key.

To access the Zone Calibration Page, enter the Setup Mode (see description earlier in this manual). Press the Page key until Zone Cal is displayed. Press the Menu key. Each parameter can be changed by pressing the Menu key until the desired parameter is displayed, and then pressing the ▲▼ keys to change the value.

Menu Item	Display	Description	Range
Zone 1 actual	Zone Cal Zone1Act	Point at which Zone 1 is set (center of chamber)	-73°C to 760°C (-100°F to 1400°F)
Zone1 displayed	Zone Cal Zone1Dis	Desired displayed value for Zone 1 setting	-73°C to 760°C (-100°F to 1400°F)
Zone 2 actual	Zone Cal Zone2Act	Point at which Zone 2 is set (center of chamber)	-73°C to 760°C (-100°F to 1400°F)
Zone2 displayed	Zone Cal Zone2Dis	Desired displayed value for Zone 2 setting	-73°C to 760°C (-100°F to 1400°F)
Factory calibration*	Zone Cal FactCal	Restores the factory calibration values	Ready or Done (push- key)

*Only use when no calibration instrument is available, push ▲ key to restore factory values.

Press the Page key to exit the Zone Calibration Page.

Two points of display calibration (temperature offset) are available. The Zone 1 Actual and Zone 2 Actual parameters are the two temperature points where the offset is to take effect. These values are adjustable. The Zone 1 and Zone 2 Displayed parameters are the values the user wishes to have displayed at the Actual temperatures, and are also adjustable.

As an example, the control is displaying 400°F with the setpoint being 400°F, but the center of the oven chamber is actually 395°F. This can occur due to oven wall losses and product loading variations. The operator may change the zone calibration so that the center of the oven is 400°F when the display reads 400°F. In this case operate the oven in manual mode with a setpoint of 400°F. Record the center of the chamber (as measured with an independent sensor). Access the Zone Calibration Page and enter this measured value as the Zone 2 Actual value, with 400° as the Zone 2 Displayed value.

Zone 1 can be adjusted using the same method at a lower temperature. The instrument will then create a linear offset based on the Zone1 and Zone 2 Actual temperature values. Note that the oven does not have to be heated to adjust the zone parameters if the zone values are known based on prior experience.

Sensor Calibration Page

The Sensor Calibration Page has parameters which can change the internal calibration of the temperature sensor input signal. There is a low and high calibration point for both the control sensor and the high limit sensor. To calibrate the instrument, allow the control to warm up for at least 30 minutes.

To access the Sensor Calibration Page, enter the Setup Mode (see description earlier in this manual). Press the Page key until Control Sensor is displayed. Press the Menu key.

The control may have the optional process value retransmission output feature. The output is a 1 to 5VDC signal. To calibrate the retransmit signal, the RetOutLo and RetOutHi values from the Control Page must be known. You may bypass calibrating the control and high limit sensor input to access only the retransmit calibration by pressing the Menu key until RetCalLo is displayed (skip steps 4-17).

To re-calibrate the instrument:

1. Disconnect the control and high limit sensor thermocouples.
2. Connect a calibration instrument with a type J thermocouple output to the control sensor input. Allow the control to warm up at least 30 minutes.
3. Access Setup Mode.
4. Press Page key until **-100F** is displayed.
5. Press Menu key until **Ctrl Sens -100F** is displayed.
6. With **Ctrl Sens -100F** displayed, adjust the calibration instrument to Type J thermocouple, -100 degrees Fahrenheit output.
7. Wait 30 seconds. Press the ▲ key.
8. With **Ctrl Sens 1400F** displayed, adjust the calibration instrument to 1400 degrees Fahrenheit output (Type J thermocouple).
9. Wait 30 seconds. Press the ▲ key.
10. When the control displays **Ctrl Sens Done**, disconnect the calibration instrument from the control sensor input and connect it to the high limit sensor input. Reconnect the control sensor thermocouple.
11. Press the Menu key until **HL Sens -100F** is displayed.
12. With the control displaying **HL Sens -100F**, adjust the calibration instrument to -100 degrees Fahrenheit output (Type J thermocouple).
13. Wait 30 seconds. Press the ▲ key.
14. With the control displaying **HL Sens 1400F**, adjust the calibration instrument to 1400 degrees Fahrenheit output (Type J thermocouple).
15. Wait 30 seconds. Press the ▲ key.
16. When the control displays **HL Sens Done**, disconnect the calibration instrument from the high limit sensor input. Re-connect the high limit sensor thermocouple.
17. To skip calibration of the retransmit signal, press the Page key twice to exit the Sensor Calibration Page.
18. To calibrate the retransmit signal, press the Menu key until **RetCalLo** is displayed.
19. Connect a calibration instrument with a type J thermocouple output to the control sensor input.

20. Connect a voltage measurement device to the retransmit output terminals.
21. Set the calibration instrument output to the temperature value of the **RetOutLo** parameter from the Control Page.
22. Adjust the **RetCalLo** * value using the ▲▼ keys until the voltage measurement device reads 1VDC.
23. Press the Menu key.
24. Set the calibration instrument output to the temperature value of the **RetOutHi** parameter from the Control Page.
25. Adjust the **RetCalHi** * value using the ▲▼ keys until the voltage measurement device reads 5VDC.
26. Press the Menu key.
27. Press the Page key to exit the Sensor Calibration Page.
28. Calibration is now complete. Disconnect the calibration instrument and voltage measurement device (if used).
29. Verify that the control and high limit sensor thermocouples are connected.

Menu Item	Display	Description	Range
Control Sensor Cal	Ctrl Sens -100F	Calibrate Sensor Low End	-100 to 1400°F
	Ctrl Sens 1400F	Calibrate Sensor High End	-100 to 1400°F
	Ctrl Sens Done	Control Sensor Cal Complete	(read only)
HiLim Sensor Cal	HL Sens -100F	Calibrate HiLim Sensor Low End	-100 to 1400°F
	HL Sens 1400F	Calibrate HiLim Sensor High End	-100 to 1400°F
	HL Sens Done	HiLim Sensor Cal Complete	(read only)
Retransmit Cal	RetCalLo XXXX *	Calibrate Retransmit Output Low	0 to 4096**
	RetCalHi XXXX *	Calibrate Retransmit Output High	0 to 4096***

*Note that the actual RetCalLo and RetCalHi values displayed are of no importance.

Enable Page

The Enable Page controls access to the other Setup Pages. The setpoint minimum and maximum values, and the security passwords are also set on the Enable Page.

To access the Enable Page, enter the Setup Mode using a level 2 access code (see description earlier in this manual). Press the Page key until Enable is displayed. Press the Menu key. Each parameter can be changed by pressing the Menu key until the desired parameter is displayed, and then pressing the ▲▼ keys to change the value.

NOTE: Changing the enable to “yes” for each page will allow access to the page in Level 1 security.

Menu Item	Display	Description	Range
Profiles	Enable Profile 1-8	Controls access to Program Page	Yes or No
Autostart	Enable Auto Start	Controls access to AutoStart Page	Yes or No **
PID	Enable PID	Controls access to PID Page	Yes or No
Control	Enable Control	Controls access to Control Page	Yes or No
Communication	Enable Communication	Controls access to Communication Page	Yes or No **
Real Time Clock	Enable Clock	Controls access to Real Time Clock Page	Yes or No **
Relay outputs	Enable Relay 1-4	Controls access to Relay Page	Yes or No **
Test	Enable Test	Controls access to Test Page	Yes or No
Zone Calibration	Enable Zone Cal	Controls access to Zone Calibration Page	Yes or No
Sensor Calibration	Enable Sensor Cal	Controls access to Sensor Calibration Page	Yes or No
Setpoint lower limit	Enable SPLowerLim	Sets minimum setpoint allowed	-73°C to 759°C (-100°F to 1399°F)
Setpoint upper limit	Enable SPUpperLim	Sets maximum setpoint allowed	-73°C to 760°C (-100°F to 1400°F)
High limit overhead	Enable HiLimOH	Sets maximum high limit setpoint allowed*	3 to 11°C (5 to 20°F)*
Password level 1	Enable Password 1	Sets password for access level 1	0 to 999
Password level 2	Enable Password 2	Sets password for access level 2	0 to 999
Setpoint Change	Enable SPChange	Set to DISABLE to lock out setpoint and high limit setpoint changes in Manual and Timer Modes	Yes or No
Analog Output Type	Enable Analog Type	Sets Analog Output type	Ctrl or Proc

* Maximum high limit setpoint = SPUpperLim + HiLimOH

** If the controller does not have this feature, “No” is the only option.

Digital Inputs (optional)

The Protocol Plus control can be run by external inputs wired to the control from an external source such as a PLC or control panel switches. The external run operation can Run, Hold or Stop profiles 1 through 7 (profile 8 can not be operated externally). Refer to the table below for the inputs required for the desired operation. NOTE: A profile must be created in the program page before trying to run a profile number.

Input 1	Input 2	Input 3	Profile Selected
ON	OFF	OFF	1
OFF	ON	OFF	2
ON	ON	OFF	3
OFF	OFF	ON	4
ON	OFF	ON	5
OFF	ON	ON	6
ON	ON	ON	7
OFF	OFF	OFF	none

To start the selected profile, set Input 1, 2, 3 or 4 to ON.

To hold a profile, set Input 4 to OFF.

To stop a profile, set all inputs to OFF.

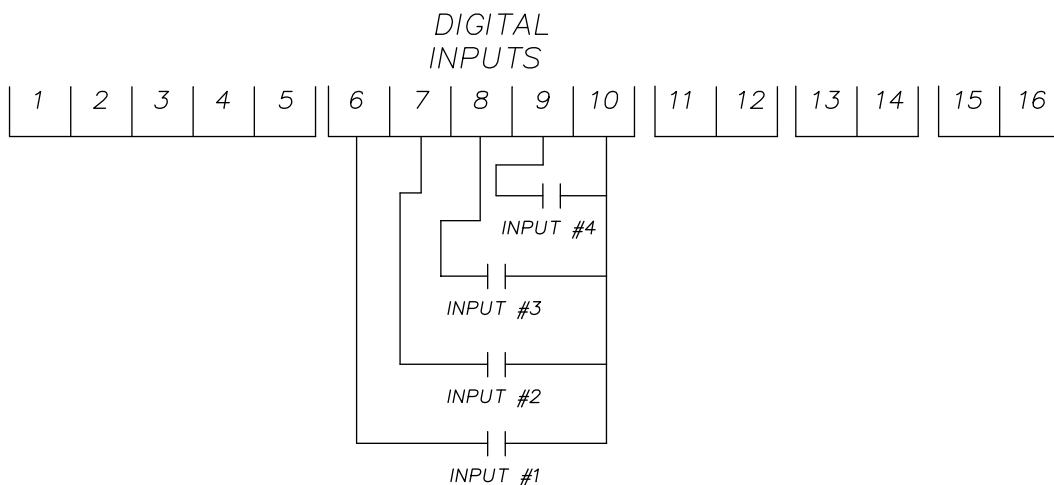

Digital Inputs

Error Messages and Alarms

The Alarm Status **Hi-limit** LED is flashing. This indicates a problem with the thermocouple, or the Hi-limit setpoint has been exceeded. Once the problem has corrected, press the Reset pushbutton.

The Alarm Status **Soak** LED is flashing. This indicates that the oven temperature has not entered or dropped out of the soak band and the soak timer has stopped.

The top LED Display reads **OPEN** and the lower LCD display reads **CONTROL SENS ERR**. This indicates that the Control thermocouple is disconnected or broken. Repair or replace the thermocouple.

The lower LCD display reads **HI-LIM SENS ERR**. This indicates that the Hi-limit thermocouple is disconnected or broken. Repair or replace the thermocouple.

The lower LCD display reads **HIGH LIMIT ALARM**. This indicates that the Hi-limit temperature setpoint has been exceeded. Determine if the setting is set too close to the setpoint, the SSR is defective, or the calibration is incorrect.

Note: The lower LCD display intermittently reads **HL Temp**. This is not an error message, but the Hi-limit thermocouple temperature reading.

Quick Reference and Default Values

Program Page

Menu Item	Display	Default	Range	Setting
Ramp Time Seg 1	Pro-1 Seg-1 Ramp Time	00:00	00m00s to 99h59s	
Event 1 Set Value	Pro-1 Seg-1 Ramp Event 1	Off	Off, On	
Event 2 Set Value	Pro-1 Seg-1 Ramp Event 2	Off	Off, On	
Event 3 Set Value	Pro-1 Seg-1 Ramp Event 3	Off	Off, On	
Event 4 Set Value	Pro-1 Seg-1 Ramp Event 4	Off	Off, On	
Soak Temp Seg 1	Pro-1 Seg 1 Soak Temp	68°F	SPLowerLim to SPUpperLim *	
Soak Time Seg 1	Pro-1 Seg 1 Soak Time	00:00	00m00s to 99h59s	
Event 1 Set Value	Pro-1 Seg-1 Soak Event 1	Off	Off, On	
Event 2 Set Value	Pro-1 Seg-1 Soak Event 2	Off	Off, On	
Event 3 Set Value	Pro-1 Seg-1 Soak Event 3	Off	Off, On	
Event 4 Set Value	Pro-1 Seg-1 Soak Event 4	Off	Off, On	
(repeat for segments 2-8)				
High Limit Setpoint	Pro-1 Hi-Lim SP	Max HiLimSP	MinHiLimSP to MaxHiLimSP *, Band **	
Loop From	Pro-1 Loop From XX	No	No, Seg-1 to Seg-8	
Loop To	Pro-1 Loop To XX	No	No, Seg-1 to Seg-8	
Loop Count	Pro-1 Loop Number	0	0 to 99	
Profile Link	Pro-1 Link To XX	Stop	Standby***, Stop, Hold, Pro-1 to Pro-8	
Guaranteed Soak	Pro-1 Guar Band	Off	Off, 1 to 778°C (1400°F)	
(repeat for profiles 2-8)				

* See Enable Page

** Band value is set on Control Page

*** If Standby

1. Cycle Complete LED indication goes ON.
2. Controller beeps if **End Of Cycle** beep is enabled.
3. Heater/control output keeps controlling oven temperature at last Soak setpoint.
4. All events programmed (if relay cards installed and programmed as an event) for the last Soak Segment stays active.

Programming Table

Profile Number _____

Profile Name _____

Segment	Ramp					Soak						
	Time	Events				Temperature	Time	Events				
		1	2	3	4			1	2	3	4	
1												
2												
3												
4												
5												
6												
7												
8												
High Limit Setpoint												
Loop From Seg												
Loop To Seg												
Loop Number												
Link To Pro												
Guar Soak Band												

Autostart

Menu Item	Display	Default	Range	Setting
Enable Autostart	Auto Start Enable	No	No, Yes	
Sunday mode	Auto Start Sun Mode	Off	Off, Manual, Timer, Pro-1 to Pro-8	
Sunday time	Auto Start Sun Time	00:00	00:00 to 23:59	
Monday mode	Auto Start Mon Mode	Off	Off, Manual, Timer, Pro-1 to Pro-8	
Monday time	Auto Start Mon Time	00:00	00:00 to 23:59	
Tuesday mode	Auto Start Tue Mode	Off	Off, Manual, Timer, Pro-1 to Pro-8	
Tuesday time	Auto Start Tue Time	00:00	00:00 to 23:59	
Wednesday mode	Auto Start Wed Mode	Off	Off, Manual, Timer, Pro-1 to Pro-8	
Wednesday time	Auto Start Wed Time	00:00	00:00 to 23:59	
Thursday mode	Auto Start Thu Mode	Off	Off, Manual, Timer, Pro-1 to Pro-8	
Thursday time	Auto Start Thu Time	00:00	00:00 to 23:59	
Friday mode	Auto Start Fri Mode	Off	Off, Manual, Timer, Pro-1 to Pro-8	
Friday time	Auto Start Fri Time	00:00	00:00 to 23:59	
Saturday mode	Auto Start Sat Mode	Off	Off, Manual, Timer, Pro-1 to Pro-8	
Saturday time	Auto Start Sat Time	00:00	00:00 to 23:59	

PID

Menu Item	Display	Default	Range	Setting
Display units	PID Temp Unit	°C	°C or °F	
Proportional band	PID Prop Band	6°C	1 to 56°C (1 to 100°F)	
Integral reset	PID Reset	2	0 to 100 seconds/repeat	
Derivative Rate	PID Rate	0	0 to 500 seconds	
AutoTune	PID AutoTune	Disable	Disable, Enable	

Control

Menu Item	Display	Default	Range	Setting
Cycle Time	Control Cycle Time	1	1 to 60 seconds	
High limit setpoint	Control Hi-Lim SP	Max HiLimSP	MinHiLimSP - MaxHiLimSP*	
High limit band	Control Hi-Lim Band	Off	Off, 3°C to 11°C (5°F to 20°F)	
Power fail recovery	Control PwrFRec	Stop	Stop, Restart, Hold, Resume	
Recovery time limit	Control PwrFTime	00m00s	00m00s to 99m59s	
Powerup start enable	Control EPwrStrt	Dis	Dis, En	
Powerup Start Mode	Control StrtMode	Off	Off, Manual, Timer, Pro-1 to Pro-8	
Hysteresis	Control Hyst	3°C	1°C to 56°C (1°F to 100°F)	
Process out low	Control RetOutLo	80°C	-73°C to 760°C (-100°F to 1400°F)	
Process out high	Control RetOutHi	400°C	-73°C to 760°C (-100°F to 1400°F)	
Time scale	Control TimeScale	hh:mm	hh:mm or mm:ss	
Key press beep	Control KeyBeep	On	On or Off	
End of cycle beep	Control EOCBeep	Off	On or Off	
Alarm beep	Control AlarmBeep	Off	On or Off	

*see Enable Page

Communication (optional)

Menu Item	Display	Default	Range	Setting
Address	Communication CommAddr	1	1 to 247	
Mode	Communication CommMode	OFF	OFF, Modbus	
Baud rate	Communication Baud Rate	19.2K	2400, 4800, 9600, 19.2K, 38.4K	
Parity	Communication Parity	None	None, Odd, Even	

Real Time Clock

Menu Item	Display	Default	Range	Setting
Day of the week	Clock Day	Mon	Sun, Mon, Tue, Wed, Thu, Fri, Sat	
Time of day	Clock HH:MM	00:00	00:00 to 23:59	
Reset clock	Clock UP to Reset CLK*	Ready	Ready, Done	

* if the ▲ key is not pressed, the clock values will retain their original values, the display will change to Done if the clock is reset

Relay Outputs (optional)

Push Select key to select relay. If Relay 0 appears, no relays are installed

Menu Item	Display	Default	Range
Type of relay	Relay 1 RelayType	Off	Off, Alarm, Cycl, Ev1 to Ev4
Action of relay	Relay 1 RelayAction	NDE	NDE, NE, NDEL, NEL*****
Type of alarm*	Relay 1 AlarmType	High	High, Low, Plus, Minus, Band
Alarm setpoint*	Relay 1 AlmHi/Lo SP	538°C	-73°C to 760°C (-100°F to 1400°F)
Alarm deviation*	Relay 1 AlmDevBand	3°C	1 to 56°C (1 to 100°F)
Inhibit alarm*	Relay 1 ALMinhibit	On	En or Dis
Type of event**	Relay 1 EventType	Time	Time or Temp
Event setpoint ***	Relay 1 Event SP	SPUpLim	SPLoLim to SPUpLim****

(repeat for relay outputs 2-4, if available)

* appears only for alarm types

** appears only for time or temperature event types

*** appears only for temperature event types

**** see enable page

***** Normally de-energized and non-latching, normally energized and non-latching, normally de-energized and latching, normally energized and latching

Table of Settings

Relay	Type	Action	Alarm/ Event Type	Setpoint	Alarm Deviation	Alarm Inhibit

Test

Menu Item	Display	Default	Range	Setting
Heater output	Test HeatOut	Off	On	
High limit relay	Test HiLimOut	Off	On	
Relay 1 output	Test Rly1 Out	Off	On	
Relay 2 output	Test Rly2 Out	Off	On	
Relay 3 output	Test Rly3 Out	Off	On	
Relay 4 output	Test Rly4 Out	Off	On	
High Limit Sensor	Test HL Temp	(sensor reading)		

Zone Cal

Menu Item	Display	Default	Range	Setting
Zone 1 actual	Zone Cal Zone1Act	38°C	-73°C to 760°C (-100°F to 1400°F)	
Zone1 displayed	Zone Cal Zone1Dis	38°C	-73°C to 760°C (-100°F to 1400°F)	
Zone 2 actual	Zone Cal Zone2Act	260°C	-73°C to 760°C (-100°F to 1400°F)	
Zone2 displayed	Zone Cal Zone2Dis	260°C	-73°C to 760°C (-100°F to 1400°F)	
Factory calibration*	Zone Cal FactCal	Ready	Ready or Done (push- key)	

*only use when no calibration instrument is available

Sensor Cal

Menu Item	Display	Default	Range	Setting
Control Sensor Cal	Ctrl Sens 0F	-100°F	-100 to 1400°F	
	Ctrl Sens 1000F	1400°F	-100 to 1400°F	
	Ctrl Sens Done	Done	(read only)	
HiLim Sensor Cal	HL Sens 0F	-100°F	-100 to 1400°F	
	HL Sens 1000F	1400°F	-100 to 1400°F	
	HL Sens Done	Done	(read only)	
Retransmit Cal	RetCalLo XXXX *	0	0 to 4096**	
	RetCalHi XXXX *	4096	0 to 4096***	

* note that the actual RetCalLo and RetCalHi values displayed are of no importance.

** press ▲▼ keys until retransmission output = 1VDC

*** press ▲▼ keys until retransmission output = 5VDC

Enable Page

Menu Item	Display	Default	Range	Setting
Profiles	Enable Profile 1-8	Yes	Yes or No	
Autostart	Enable Auto Start	No	Yes or No **	
PID	Enable PID	Yes	Yes or No	
Control	Enable Control	No	Yes or No	
Communication	Enable Communication	No	Yes or No **	
Real Time Clock	Enable Clock	No	Yes or No **	
Relay outputs	Enable Relay 1-4	No	Yes or No **	
Test	Enable Test	No	Yes or No	
Zone Calibration	Enable Zone Cal	No	Yes or No	
Sensor Calibration	Enable Sensor Cal	No	Yes or No	
Setpoint lower limit	Enable SPLowerLim	20°C	-73°C to 759°C (-100°F to 1399°F)	
Setpoint upper limit	Enable SPUpperLim	260°C	-73°C to 760°C (-100°F to 1400°F)	
High limit overhead	Enable HiLimOH	5°C	3 to 11°C (5 to 20°F)*	
Password level 1	Enable Password 1	1	0 to 999	
Password level 2	Enable Password 2	2	0 to 999	
Manual/Timer mode setpoint change	Enable SPChange	Yes	Yes or No	
Analog Output Type	Enable Analog Type	Proc	Ctrl or Proc	

* Maximum high limit setpoint (MaxHiLimSP) = SPUpperLim + HiLimOH
 Minimum high limit setpoint (MinHiLimSP) = SPLowerLim + HiLimOH

** If the controller does not have this feature, “No” is the only option.

Technical Specifications

UL, cUL listed:	UL file E136675
CE compliance to:	<ul style="list-style-type: none">• EMC Directive 89-366/EEC• European Standard EN55011/1991• European Standard EN50082-2/1995
Power supply:	<ul style="list-style-type: none">• 100 to 240 VAC +10% -15%, 50-60Hz, 30VA Maximum• 12 to 24 VAC/VDC +/-10%, DC to 60Hz, 30VA Maximum
Temperature:	<ul style="list-style-type: none">• Storage -20 to 60°C• Operating 0 to 50°C
Humidity:	90% or less, non-condensing
Sensor inputs:	<ul style="list-style-type: none">• Type J thermocouple -73°C to 760°C (-100°F to 1400°F)• Input impedance 1M ohm or greater• Common mode noise rejection of 140db@60Hz• Common mode input voltage of +/-12.0VDC• Sample rate of at least 1 sample per second• Stability of +/- 0.5°C per 5°C change in ambient temperature• Repeatability of +/- 0.5°C, or +/-0.1% of sensed temperature (whichever is greater)• Accuracy (@ 77°F +/-0.2 percent of span (+/-3°F)• Supply Voltage Influence of +/-0.5°C per 10% change in nominal line voltage
Temperature display:	<ul style="list-style-type: none">• 1 degree resolution (C or F)• Accuracy after calibration of +/- 1°C, or +/-0.2% of sensed temperature (whichever is greater) @25°C• Four-digit seven-segment LCD, 0.43 inches high (11mm)• Readout Stability (+/-1°F/10°F Change in ambient temperature)
Message display:	<ul style="list-style-type: none">• Two-line, 16 alpha-numeric 5x7 dot matrix characters per line• 0.2 inches high (5mm)
Time base:	+/- 4 seconds accuracy in 24 hours
Heat control output:	SSR Drive 24VDC nominal @ 70mA
Relay output: (plug-in module)	Form A dry contact, rated 3 amps @ 24-264VAC
Retransmit output:	1 to 5 VDC into > 100K ohm load
Communications: (plug-in module)	<ul style="list-style-type: none">• RS232 Single drop, isolated• RS422 Multi-drop, isolated• RS485 Multi-drop, isolated
Remote inputs: (plug-in module)	Dry-contact closure type with less than 250 ohm ON resistance
Front panel:	NEMA 4X (with gasket)
Dimensions:	3.57H x 7.24W x 2.84D inches (91H x 184W x 72D mm)
Panel opening:	3.63H x 7.30W inches (92H x 185W mm)

MAINTENANCE

WARNING: Do not attempt any service on this oven unless the main power disconnect switch is opened.

Checklist

- Keep equipment clean. Gradual dirt accumulation retards air flow. A dirty oven can result in unsatisfactory operation such as unbalanced temperature in the work chamber, reduced heating capacity, reduced production, overheated components, etc. Keep the walls, floor and ceiling of the oven work chamber free of dirt and dust. Floating dust or accumulated dirt may produce unsatisfactory work results. Keep all equipment accessible. Do not permit other materials to be stored or piled against it.
- Protect controls against excessive heat. This is particularly true of controls, motors or other equipment containing electronic components. Temperatures greater than 51.5°C (125°F) should be avoided.
- Establish maintenance & checkup schedules. Do this promptly and follow the schedules faithfully. Careful operation and maintenance will be more than paid for in continuous, safe and economical operation.
- Maintain equipment in good repair. Make repairs immediately. Delays may be costly in added expense for labor and materials and in prolonged shut down.
- Practice safety. Make it a prime policy to know what you are doing before you do it. Make CAUTION, PATIENCE, and GOOD JUDGEMENT the safety watchwords for the operation of your oven.
- Lubrication. Fan motor bearings are permanently lubricated. All door latches, hinges, door operating mechanisms, bearing or wear surfaces should be lubricated to ensure easy operation.

Tests

Tests should be performed carefully and regularly. The safety of personnel as well as the condition of equipment may depend upon the proper operation of any one of the functions of the temperature control. Test the control every 40 hours. Check that the heater LED is cycling on and off, indicating that the heater is working. Also check the high limit function to make sure it is working properly.

To test the high limit:

1. Go to Manual Mode and enter control setpoint value at least 20°F (11°C) lower than the current process temperature.
2. Press the Menu key and lower the high limit setpoint to a value just below the current process temperature.
3. The high limit alarm indicator should flash and a high limit alarm message should be displayed. Verify that the heater relay has been disabled by checking that 2LED on the control panel circuit board is not lit.
4. Return the control setpoint and high limit setpoint values to their original values.
5. Press the Reset key.

Replacement

Parts

To order or return parts, contact the Service Products Division at Despatch. The Service Products features our Response Center for customer service. When returning parts, a Despatch representative will provide you with an MRA (Material Return Authorization) number. The MRA number must be attached to the returned part for identification. When you are ordering parts, be sure to give the model number, serial number and the part number. This will expedite the process of obtaining a replacement part.

When you have a **service** need, contact the **Response Center** at **1-800-473-7373**: FAX 612-781-5353.

WARNING:

Disconnect the main power switch or power cord before attempting any repair or adjustment.

Protocol Plus™ Instrument

(Tools needed: 1/4" socket driver with #1 bit, #2 Phillips screwdriver)

1. Disconnect the power.
2. Unplug all terminals on the rear of the control, noting the proper connections.
3. Remove the screws from the control panel and slide it forward.
4. Remove the four retaining clips for the control.
5. Remove the control.
6. Insert the new control into the panel.
7. Fasten the four retaining clips.
8. Re-plug all terminals.
9. Fasten the control panel.

WARNING:

Make certain that main AC power is DISCONNECTED before replacing or maintaining any components on the oven.

Heater Unit

(Tools needed: 3/8" wrench, square recess driver with #1 bit)

1. Disconnect the power.
2. Remove the left and right inside walls.
3. Remove the chamber floor plate from the oven.
4. Disconnect the heater leads from heater element with wrench. Note which wires go on which terminals.
5. Unscrew the screws holding the heater frame to the oven body.
6. Remove the heater and discard.
7. Screw down the new heater frame.
8. Attach the heater leads to appropriate terminals.
9. Replace the interior floor.
10. Replace the inside walls.

Fan Motor

(Tools needed: Screwdriver, 5/32 inch Allen wrench, one quarter (¼) inch socket set)

1. Remove the left and right inside walls.
2. Remove the chamber floor plate from the oven.
3. Remove the fan inlet plate.
4. Loosen the set screws (2) on fan wheel.
5. Remove the side access panel. This will reveal the fan motor.
6. Remove the fan motor.
 - a. Disconnect the motor leads from the circuit board.
 - b. Remove the screws (4) holding motor to the base.
 - c. Lift the fan motor from the oven body.

After the fan wheel has run at temperature for awhile, it will stick to the shaft. Some force may be required to separate the fan wheel from the fan motor shaft.

7. Replace the fan motor.
 - a. Insert the shaft into shaft collar. Put the fan wheel onto shaft from inside oven.
 - b. Reattach the motor to motor base.
 - c. Reattach the motor lead wires to the circuit board.
8. Adjust the fan wheel for 3/16 inch clearance between the wheel and the inlet ring.
9. Tighten the set screws on the fan wheel.
10. Check that the set screws hit the flats machined into the motor shaft.
11. Replace the chamber floor plate.
12. Replace the left and right side walls.
13. Replace the side access panel.

TROUBLESHOOTING

Equipment which operates for long periods of time may develop problems. Below are possible problems and suggested solutions. If you have a problem not listed and do not know what to do, contact Despatch Industries at our toll free Help Line 800-473-7373.

Difficulty	Probable Cause	Suggested Remedy
Failure to heat or heats up to only 35-50°C	No power	Check power source and/or oven and wall fuses.
	Burned out heater	Replace heater (see warranty.)
	Protocol™ malfunction	Replace controller.
	Loose wire connections	Disconnect power and check connections behind control panel.
	Heater relay failure	Replace circuit board.
	Door switch failure (if installed)	Replace door switch.
Slow heat up	Improperly loaded	Reduce load or redistribute load in chamber.
	Low line voltage	Supply sufficient power and proper connections. Check for circuit overload.
	Heating element(s) are burned out	Replace heater (see warranty statement.)
	Fan motor failure	Replace fan motor.
Frequent heater element burnout	Harmful fumes generated by load	Increase vent opening or discontinue process.
	Spillage or splattering of material on heater elements	Disconnect power and clean oven chamber and elements.
	Overheating oven	Check the Hi-limit.
Erratic temp. or inaccurate temp.	Protocol™ malfunction	Replace Protocol™.
	Improper tuning parameters	Check tuning parameters.
	Protocol™ miscalibration	Recalibrate Protocol™ (see section on Calibration mode.)
	Hi-limit setting	Hi-limit should be 10-25°C higher than setpoint.
	Improper offset	Check zone calibration.
Excess surface or door temp.	Door seal deterioration	Replace door seal.
Improper airflow	Fan motor failure	Replace fan motor.
	Fan wheel seated too low on fan shaft	Adjust fan wheel for 3/16" clearance between wheel and inlet ring.
	Unbalanced fan wheel	Replace fan wheel.

Difficulty	Probable Cause	Suggested Remedy
Excessive vibration	Dirty fan wheel	Clean fan.
	Unbalanced fan wheel	Replace fan wheel.
Oven will not control at setpoint	Hi-limit set too low	Set the Hi-limit higher
	Protocol malfunction	Replace control.
	SSR malfunction	Replace SSR and/or check control output voltage.
	Air friction of recirculation fan	Open exhaust air vent. Unit will not control below minimum operating temperature with vent closed.
Heater does not shut down until temp. reaches the Hi-limit setting	Protocol malfunction	Replace Protocol
	SSR malfunction	Replace SSR

NOTE: The circuit board mounted on the control panel has three status LED indicators to help troubleshoot if the oven is not heating.

- A. If LED 1 is not lit, check 2F and 3F (control fuses), or power switch.
- B. If LED 1 and LED 3 are lit but not LED 2, check high limit (and optional door switch, if installed).
- C. If all three LEDs are lit, check 1F and 4F (heater fuses), SSR, heater, and heater relays.

DRAWINGS

Electrical drawings for the RAD/RFD series are found on the next six pages.

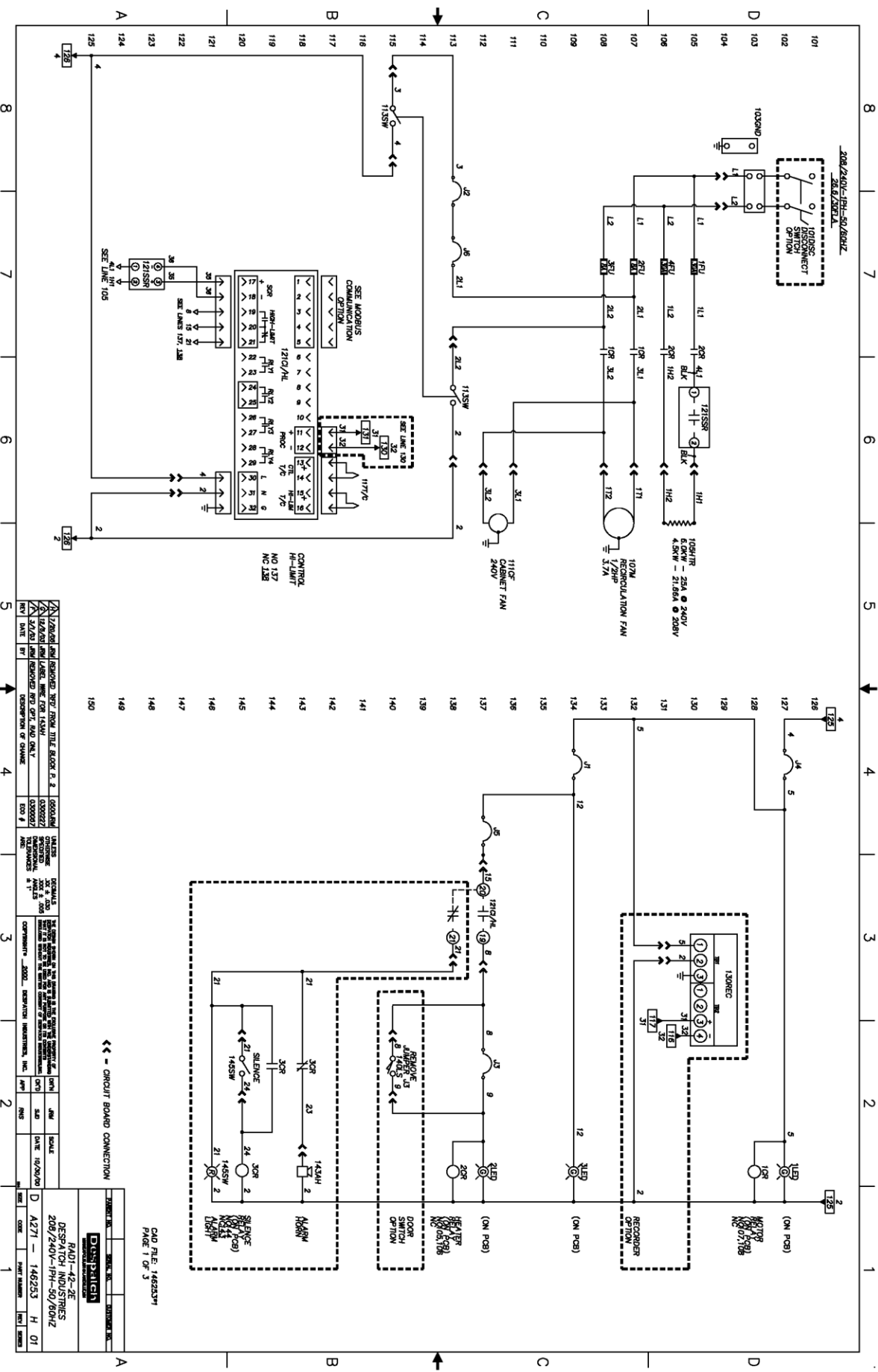

REV	DATE	BY	DESCRIPTION
1	12/28/00	AW	REWORKED FROM TITLE BLOCK P. 2
2	12/28/00	AW	REWORKED FROM TITLE BLOCK P. 2
3	12/28/00	AW	REWORKED FROM TITLE BLOCK P. 2
4	12/28/00	AW	REWORKED FROM TITLE BLOCK P. 2
5	12/28/00	AW	REWORKED FROM TITLE BLOCK P. 2
6	12/28/00	AW	REWORKED FROM TITLE BLOCK P. 2
7	12/28/00	AW	REWORKED FROM TITLE BLOCK P. 2
8	12/28/00	AW	REWORKED FROM TITLE BLOCK P. 2

← ← ← CIRCUIT BOARD CONNECTION

CAD FILE: 146233*
PAGE 1 OF 3

DESIGNER	DATE	SCALE
AW	12/28/00	D
CHECKED	DATE	SCALE
AW	12/28/00	D

Dynalisc
DESIGNATION INDUSTRIES
208/240V-1PH-50/60HZ
A271 - 146233 H 01

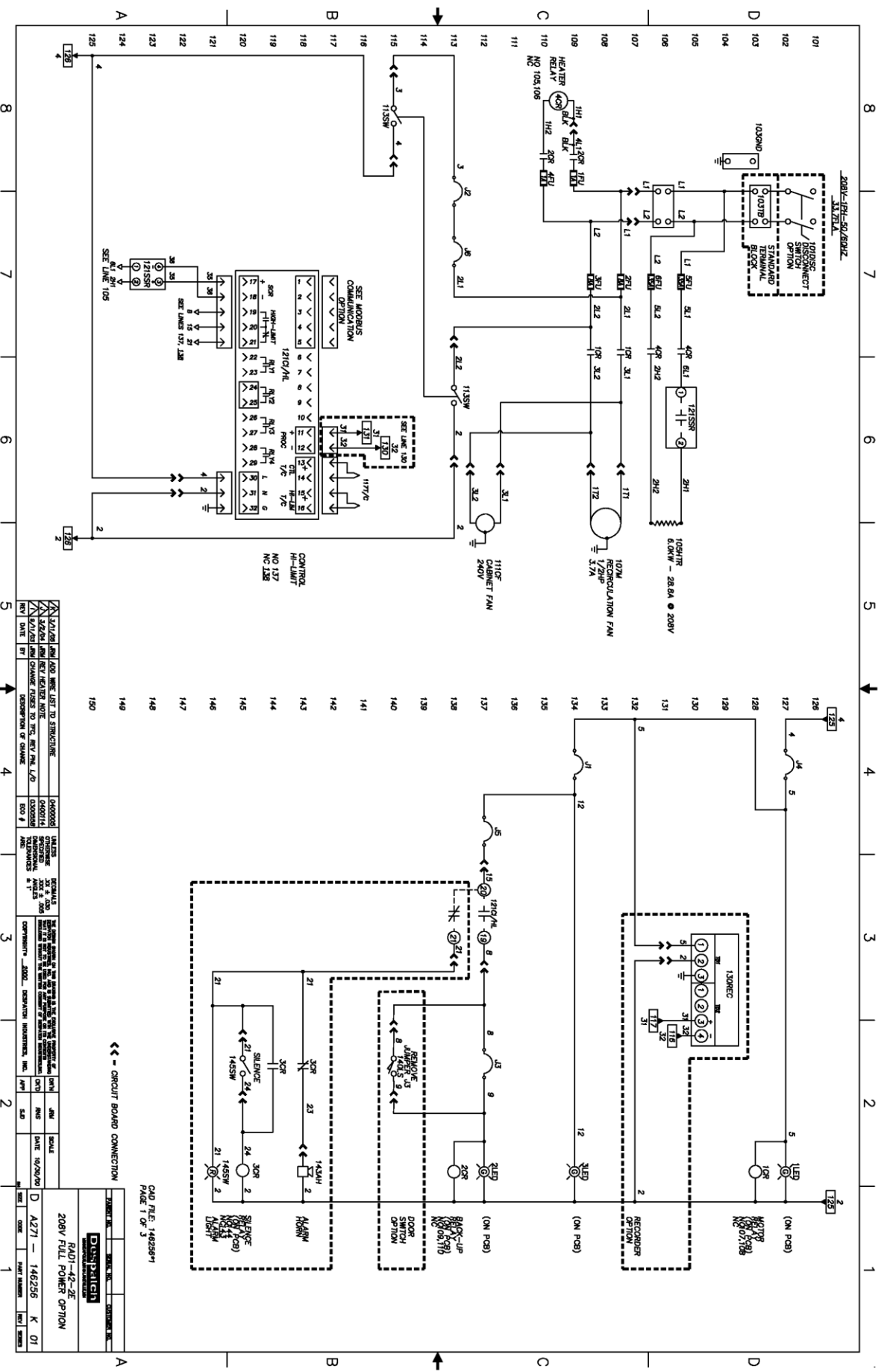

REV	DATE	BY	CHK	DESCRIPTION OF CHANGE	DESIGNED	CHECKED	DATE	BY	CHK	SCALE	DATE	BY	CHK
1													
2													
3													
4													

208V FULL POWER OPTION
 RADJ-42-2E
 1462256 K 01
 A271
 10/20/00
 1462256 K 01
 10/20/00

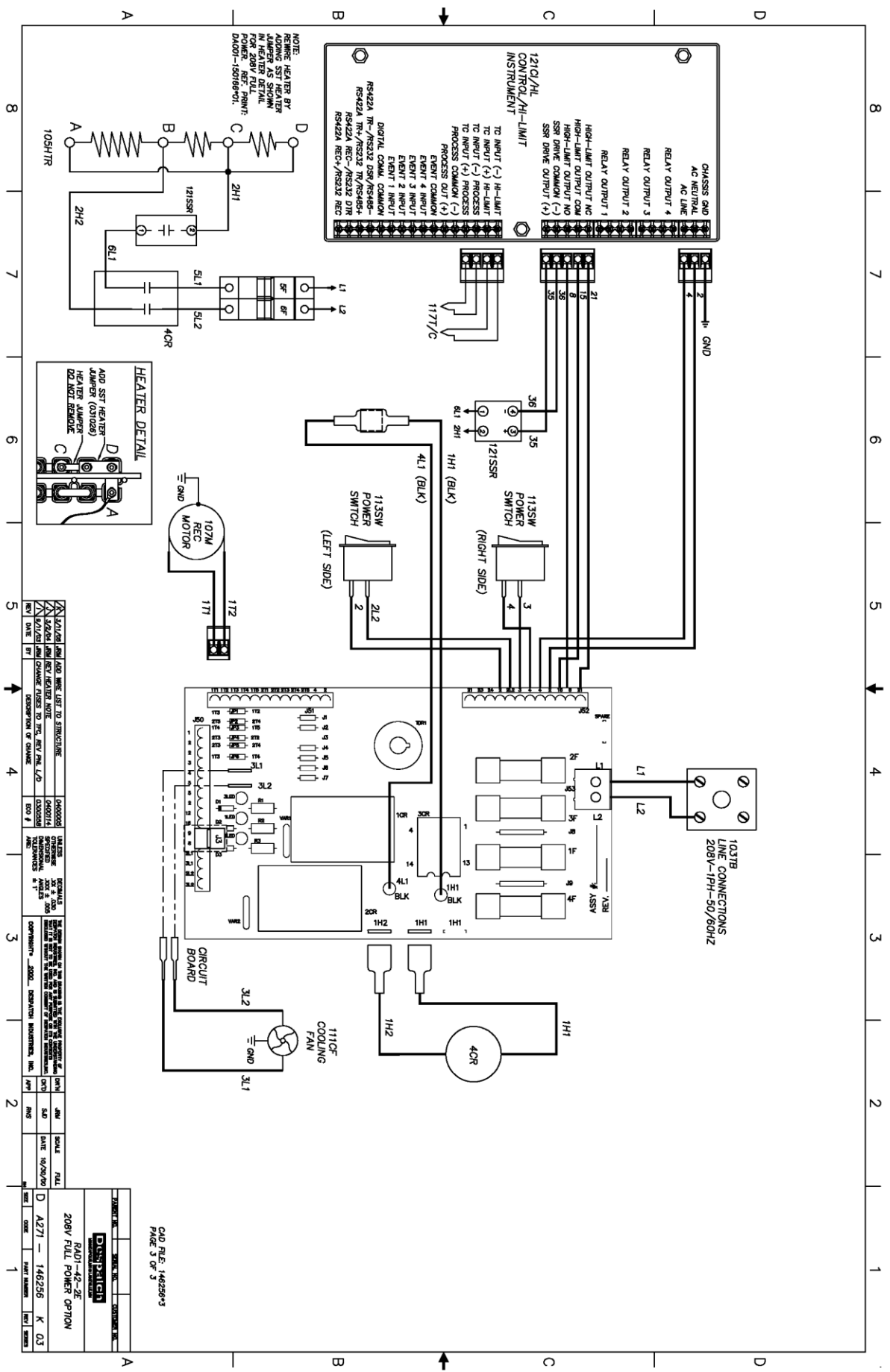

REV	DATE	BY	CHK	DESCRIPTION OF CHANGE
1				
2				
3				
4				
5				

SCALE	FILE	DATE	REV	BY	CHK	APP
D	A271	10/20/90				

DUNPAC 208V FULL POWER OPTION CAD FILE: 146256*3 PAGE 3 OF 3		RADI-42-ZE 208V FULL POWER OPTION K 03
--	--	--

APPENDIX

Temperature Scale Conversion (C/F)

The Protocol Plus controller can be operated in either C or F. The default setting for the controller is C. Changing from one to the other is as follows:

1. Go into the **Setup Mode** on the controller.
2. Press the **Select** Key until **Setup** is displayed.
3. Press the **Page** key and **Security** will be displayed.
4. Press the **Menu** Key and **Password** will be displayed. Use the **arrow** keys to enter the proper password. The default password is 2 for level two.
5. Once the proper password is displayed, press the **Page** key until **PID** is displayed.
6. Press the **Menu** key and **Temp Unit** along with C or F will be displayed. Use the arrow keys to change the setting.
7. Once the proper setting is displayed, press and hold the **Page** key for approximately three seconds to exit the **Setup Mode**.

Optional MRC5000 Recorder Setup

The temperature is retransmitted to the Recorder from the Controller. Set up the Recorder as follows:

1. Make sure that jumper **JU1** is setup for the **5 VDC** setting (see MRC Manual).
2. Move the **Mode** switch to the **PROG/TEST/CAL** position, and **Prog** will be displayed.
3. Press the **down arrow** key twice and **Inps** will be displayed. Make sure the settings are per the table below.
4. Once all the settings have been changed, move the **Mode** switch to the **RUN** position. The display on both the Recorder and controller should read the same.

Parameter Code	Degrees C	Degrees F
Inps	17	17
Icor	0	0
diSP	On	On
dPOS	0	0
EUU **	400	752
EUL **	0	32
ChUP	400	800 *
ChLO	0	0
DFF	1	1

* Note: The 0 - 400 chart paper must be changed to the 0 - 800 chart paper. Depending on the equipment, 0 - 600 paper can be used if the maximum temperature is 500 degrees F.

** Note: These values must match the setting sRetOutLo and RetOutHi on the Control page on the Protocol Plus controller (example: RetOutLo is 32, then EUL must read 32).