

INSPIRED INNOVATION

Despatch
INDUSTRIES

LAC-6 SERIES OVEN OWNER'S MANUAL

C-194
PN 150138
VERSION 16
3/2011

SERVICE AND TECHNICAL SUPPORT

service parts: 1-800-473-7373

international service/main: 1-952-469-8230

service fax: 1-952-469-8193

service@despatch.com

GLOBAL HEADQUARTERS

phone: 1-952-469-5424

toll free usa: 1-888-337-7282

fax: 1-952-469-4513

sales@despatch.com

service@despatch.com

8860 207th Street West
Minneapolis, MN 55044 USA

Despatch
INDUSTRIES

Revision History

Revision	Date	Author	Description
B			Updated contents of Drawings Section Updated Protocol Plus instructions
C			Added "Operating Environment" note to Operating section. Updated drawings. Modified Preface
D			Modified per Rev C Protocol Plus software
E			Various corrections
F			Updated drawings
G			Updated Despatch warranty.
H			Updated drawing
I			Update to Protocol Plus Version 4
J			Ref. CAR 1165C
K			Changes to Unpacking and Inspection
L			Changed drawings
M			Revised Protocol numbers. Updated Despatch address
N			Updated warranty
O			Updated Protocol Plus Section
16	3/2011	K. Livingston	Revise format.

Copyright © 2011 by Despatch Industries.

All rights reserved. No part of the contents of this manual may be reproduced, copied or transmitted in any form or by any means including graphic, electronic, or mechanical methods or photocopying, recording, or information storage and retrieval systems without the written permission of Despatch Industries, unless for purchaser's personal use.

Table of Contents

1.	About This Manual	5
1.1.	Important User Information	5
1.2.	Manufacturer & Service.....	6
1.3.	Organization of this Manual	6
1.4.	Conventions	7
1.5.	Specifications	8
1.5.1.	Dimensions.....	8
1.5.2.	Capacities	9
1.5.3.	Power.....	10
1.5.4.	Temperature	11
2.	Safety	12
2.1.	Safety Information	12
2.1.1.	Lockout.....	12
2.1.1.1.	Lockout Requirements.....	12
2.1.1.2.	Lockout Procedure.....	12
2.1.2.	Door and Panel	13
2.2.	Maintenance.....	13
2.3.	Electrical Power	13
2.4.	Fire	14
2.5.	Equipment Lockout Requirements	15
2.5.1.	Emergency Stop	15
3.	Theory of Operation.....	16
3.1.	The LAC-6 Series Oven.....	16
3.2.	Damper Control	17
3.2.1.	Determining Damper Settings.....	17
3.2.1.1.	Damper Full-Closed Position	17
3.2.1.2.	Damper Full-Open Position.....	17
3.2.1.3.	Other Damper Settings	18
3.3.	The Protocol Plus Controller	19
4.	Assembly & Setup	20
4.1.	Unpack & Inspect the LAC-6 Series Oven.....	20
4.1.1.	If Damaged During Shipping	20
4.2.	Set-up the LAC-6 Series Oven	20
4.2.1.	Select Oven Location/Operating Environment	20
4.2.2.	Set-up Procedure	21
4.2.3.	Wiring & Power Connections	22
4.2.3.1.	Wire LAC-6 Models 2-12 and 2-18	23
4.3.	MRC5000 Setup (Optional).....	25
5.	Operation.....	26
5.1.	Load Oven.....	26
5.2.	Pre-Startup Checklist	27
5.3.	Operating Procedure	28
5.3.1.	Start Oven.....	28
5.3.2.	Working with Protocol Plus Operating Modes	28
6.	Maintenance	29

Copyright © 2011 by Despatch Industries.

All rights reserved. No part of the contents of this manual may be reproduced, copied or transmitted in any form or by any means including graphic, electronic, or mechanical methods or photocopying, recording, or information storage and retrieval systems without the written permission of Despatch Industries, unless for purchaser's personal use.

6.1.	Checklist	29
6.2.	Lubrication	30
6.3.	Routine Tests	30
6.4.	Door Adjustment.....	30
6.5.	Replacement Parts.....	30
6.5.1.	Replace the Protocol Plus Controller	31
6.5.2.	Replace Heater Unit	31
6.5.3.	Replace Fan Motor	32
7.	Troubleshooting	34
7.1.	Troubleshooting Error Messages and Alarms.....	34
7.2.	Troubleshooting Symptoms	34
8.	Appendices.....	36
8.1.	Standard Products Warranty	36
8.2.	Electrical Schematics	37

Figures

Figure 1.	LAC High-performance Bench-top Oven.	16
Figure 2.	Horizontal Airflow through the LAC Oven.	16
Figure 3.	Damper Positions.....	17
Figure 4.	Protocol Plus Displays and Control Buttons.	19
Figure 5.	LAC-6 Series Oven Nameplate.....	22
Figure 6.	Rear Access Panel for Hard-Wired Connections.	23
Figure 7.	Hinged Panel for Simpler Access to Power Connections.	23
Figure 8.	Power Connections at Main Circuit Board.....	24
Figure 9.	Remove Screws to Remove Floor Plate.....	31
Figure 10.	Heater Panel and Inlet Cone.....	31
Figure 11.	Remove Screws to Remove Side Panels.	32
Figure 12.	Remove Heater Panel by Removing Screw in Front Edge of Each Panel.	32
Figure 13.	LAC1-10-6 (Excerpt from drawing 146271D01).....	38
Figure 14.	LAC1-38A-6 (Excerpt from drawing 146273D01).....	38
Figure 15.	LAC1-38B-6 (Excerpt from drawing 146275D01).....	38
Figure 16.	LAC1-67-6 (Excerpt from drawing 146277D01).....	38
Figure 17.	LAC2-12-6 (Excerpt from drawing 146279D01).....	38
Figure 18.	LAC2-18-6 (Excerpt from drawing 146281E01).....	38

Tables

Table 1.	MRC 5000 Settings.....	25
Table 2.	Error Messages and Next Steps.....	34
Table 3.	Troubleshooting Oven Symptoms.....	35

1. About This Manual

1.1. Important User Information

Copyright © 2011 by Despatch Industries.

All rights reserved. No part of the contents of this manual may be reproduced, copied, or transmitted in any form or by any means including graphic, electronic, or mechanical methods or photocopying, recording, or information storage and retrieval systems without the written permission of the publisher, unless it is for the purchaser's personal use.

Printed and bound in the United States of America.

The information in this manual is subject to change without notice and does not represent a commitment on the part of Despatch Industries. Despatch Industries does not assume any responsibility for any errors that may appear in this manual.

In no event will Despatch Industries be liable for technical or editorial omissions made herein, nor for direct, indirect, special, incidental, or consequential damages resulting from the use or defect of this manual.

	<p><i>Values displayed on screens are examples only. Though those values may be typical, contact Despatch Industries for the final value.</i></p>
---	--

	<p><i>Users of this equipment must comply with operating procedures and training of operation personnel as required by the Occupational Safety and Health Act (OSHA) of 1970, Section 6 and relevant safety standards, as well as other safety rules and regulations of state and local governments. Refer to the relevant safety standards in OSHA and National Fire Protection Association (NFPA), section 86 of 1990.</i></p>
---	---

Copyright © 2011 by Despatch Industries.

All rights reserved. No part of the contents of this manual may be reproduced, copied or transmitted in any form or by any means including graphic, electronic, or mechanical methods or photocopying, recording, or information storage and retrieval systems without the written permission of Despatch Industries, unless for purchaser's personal use.

	<p>Danger!</p> <p><i>Only fully-trained and qualified personnel should setup and maintain this equipment. Improper setup and operation of this equipment could cause an explosion that may result in equipment damage, personal injury or possible death.</i></p>
---	--

The information in this document is not intended to cover all possible conditions and situations that might occur. The end user must exercise caution and common sense when installing or maintaining Despatch Industries products. If any questions or problems arise, call Despatch Industries at 1-888-DESPATCH or 1-952-469-5424.

1.2. **Manufacturer & Service**

The LAC-6 Series Oven is manufactured by Despatch Industries.

Despatch has specialized in thermal processing for over 100 years. Technical expertise gained over those years helps provide innovative solutions to critical applications in vertical markets and cutting edge technology worldwide. Despatch products are backed by a drive for long-term customer satisfaction and a strong sense of responsibility. The worldwide network of factory-trained Service Professionals is available to support your Despatch equipment. From full service preventive maintenance to routine repair and certified calibration and uniformity, the Despatch service network is positioned to respond to your business needs. Our service programs are customized to meet your specific needs using our Advantage Service Assurance Program (ASAP). For more information on ASAP, visit www.despatch.com.

Global Headquarters	Contact	Service & Technical Support
Despatch Industries 8860 207th Street Lakeville, MN 55044 USA	International/Main: 1-952-469-5424 US toll free: 1-888-337-7282 Fax: 1-952-469-4513 info@despatch.com www.despatch.com	Service: 1-952-469-8230 US toll free: 1-800-473-7373 Service @despatch.com

1.3. **Organization of this Manual**



This owner's manual contains the most comprehensive set of information for the Despatch LAC-6 Series ovens, including installation instructions, theory of operation, operating instructions, among other things.

Copyright © 2011 by Despatch Industries.

All rights reserved. No part of the contents of this manual may be reproduced, copied or transmitted in any form or by any means including graphic, electronic, or mechanical methods or photocopying, recording, or information storage and retrieval systems without the written permission of Despatch Industries, unless for purchaser's personal use.

	<p><i>Danger!</i></p> <p><i>Failure to heed warnings in this instruction manual and on the oven could result in personal injury, property damage or death.</i></p>
---	---

1.4. Conventions

	<p><i>This icon signifies important information.</i></p>
	<p><i>This icon signifies information that describes an unsafe condition that may result in death, serious injury, or damage to the equipment.</i></p>
<p>Danger!</p>	<p><i>A condition that may result in death, serious injury, or damage to equipment.</i></p>
<p>Warning!</p>	<p><i>A condition that may result in serious injury or damage to equipment.</i></p>
<p>Caution!</p>	<p><i>A condition that may result in damage to equipment or product.</i></p>
<p>LOG OUT</p>	<p><i>Reversed-out, Bold, 10pt Arial typeface indicates a specific key or button on screen to click.</i></p>

1.5. Specifications

1.5.1. Dimensions

LAC Model No.	Chamber Size in (cm)			Capacity feet ³ (liters)	Overall Size in (cm)			Max. Number of Shelf Positions	Exhaust Diameter Located on Back of Chamber in (cm)
	W	D	H		W	D	H		
1-10	13.75 (35)	12 (28)	12 (31)	1 (33)	23 (58)	19 (48)	29.5 (75)	5	1 (2.5)
1-38A	18.75 (48)	18 (46)	19 (48)	3.7 (105)	28 (71)	25 (64)	35.5 (90)	9	2½ (6.4)
1-38B	18.75 (48)	18 (46)	19 (48)	3.7 (105)	28 (71)	25 (64)	35.5 (90)	9	2½ (6.4)
1-67	23.75 (60)	20 (51)	24 (61)	6.6 (187)	36 (91)	27 (69)	40.5 (103)	11	2½ (6.4)
2-12	23.75 (60)	24 (61)	36 (91)	12 (340)	36 (91)	31 (79)	52.5 (133)	17	2 x 2½ (6.4)
2-18	35.25 (91)	24 (61)	36 (91)	18 (510)	47 (119)	29.5 (75)	52.5 (133)	17	2 x 2½ (6.4)



The LAC-6 oven is not intended to process solvents or other volatile or flammable materials. Oven exhaust is intended for cooling purposes only.



Warning!

Do not place this oven in an environment harmful to electrical components.

Placing this oven in an environment detrimental to electrical components (for example, environments where carbon fibers, coal dust or similar contaminants may be present) may result in component failure.

Contact Despatch for options available to help prevent such failures.

* Allow 0.375" (0.95 cm) clearance on each side for shelf supports (3/4 in (1.9 cm) total).

1.5.2. Capacities

LAC-6 Model Number		1-10-6	1-38 A-6 & B-6	1-67-6	2-12-6	2-18-6
Maximum Load	Lbs (Kg)	150 (68)	175 (79)	250 (113)	300 (136)	300 (136)
Maximum Shelf Load	Lbs (Kg)	50 (23)	50 (23)	50 (23)	50 (23)	50 (23)
Exhaust	CFM (LPS)	Adjustable to 5 (2.4)	Adjustable to 12 (5.6)	Adjustable to 12 (5.6)	Adjustable to 30 (14.2)	Adjustable to 40 (18.9)
Recirculating Fan	CFM (LPS)	150 (71)	300 (141)	300 (141)	600 (282)	600 (282)
	H.P.	1/25	¼	¼	¼ x 2	¼ x 2
Approx. Weight Net	Lbs (KG)	110 (50)	185 (84)	255 (116)	360 (163)	450 (204)
Shipping Weight	Lbs (KG)	175 (79)	270 (123)	360 (163)	480 (218)	600 (272)

1.5.3. Power

If the line voltage for your LAC-6 Series Oven varies more than 10% from the oven voltage rating, electrical components such as relays and temperature controls may operate erratically.

- If the line voltage is lower than the oven voltage rating, heat-up time may be significantly longer and motors may overload or run hot
- If the line voltage is higher than the nameplate rating, motors may run hot and draw excessive amperage

Model	Volts	Amps	Hertz	Phase	Heater KW	Cord and Plug
LAC 1-10-6	120	10.0	50/60	1	1	Included, 15 Amp (NEMA 5-15)
LAC 1-38A-6	120	16.5	50/60	1	1.6	Included, 20 Amp (NEMA 5-20)
LAC 1-38B-6 [†]	240	9.5	50/60	1	1.8	Included, 15 Amp (NEMA 6-15)
LAC 1-67-6 [†]	240	12.0	50/60	1	2.4	Included, 15 Amp (NEMA 6-15)
LAC 2-12-6 ^{† ‡}	240	18.5	50/60	1	3.6	None, Hardwired
LAC 2-18-6 ^{† ‡}	240	23.5	50/60	1	4.8	None, Hardwired

[†] The LAC Series Oven designed for 240 volts (see oven nameplate) will operate satisfactorily on a minimum of 208 Volts, but will result in 25% reduced heater output. If your power characteristic is lower, contact Despatch Industries. An option is available to regain the full heater power when operating on 208V.

[‡] The LAC 2-12 and LAC 2-18 must be hardwired to the electric supply using 10 AWG or larger wires suitable for at least 75 °C (167 °F).

1.5.4. Temperature

LAC-6 Model Number		1-10	1-38 A	1-38 B	1-67	2-12	2-18
Time to Temperature (approximate minutes with no load)	40 °C – 100 °C	8	9	6	6	6	4
	40 °C – 200 °C	25	32	22	20	19	17
	40 °C – 260 °C	40	60	36	34	31	29
Recovery Time - Door Open One Minute (approximate minutes with no load)	100 °C	1	1	1	1	1	1
	200 °C	3	6	4	3	6	4
	260 °C	7	14	8	5	9	8
Temperature Uniformity at	100 °C [§] 200 °C [§] 260 °C [§]	± 1 °C ± 2 °C ± 2.5 °C					
Operating Range with 20 °C Ambient	40 °C – 260 °C						
Control Stability	± 0.5 °C per 5 °C change in ambient						
Repeatability	± 0.5° C						

[§] Figures are based on actual tests in an empty oven. Uniformity can vary slightly depending on unit and operating conditions.

2. Safety

2.1. Safety Information

Do not work on the LAC-6 Series Oven without reading and understanding this section which contains important information and warnings. Ignoring these warnings can result in death, serious injury or damage to the machine and product.

2.1.1. Lockout



Carefully follow the established Lock Out Tag Out policies of your company in all cases.

Machine lockout places the LAC-6 Series Oven into a zero energy state and prevents accidental machine start up. Always follow the Lockout Procedure described in this Section before cleaning, maintaining or repairing the LAC-6 Series Oven. An accidental start-up, while working on the LAC-6 Series Oven, can result in serious injury or death.

2.1.1.1. Lockout Requirements

1. Every power source that can energize any element of the LAC-6 Series Oven must be shut off at the closest possible power source. This includes air, water and electricity, including the Disconnect Switch.
2. After energy sources are locked out, test to ensure circuits are de-energized.

2.1.1.2. Lockout Procedure



Danger!

Electrical panels contain high voltage. Disconnect and lock out the power supply before working inside any electrical panels. Failure to lock out the power supply can result in death or injury.

Personnel authorized to lockout equipment must have the necessary locks to perform the lockout.

1. Physically disconnect all electrical power to the machine or lockout the appropriate breaker or disconnects.

Copyright © 2011 by Despatch Industries.

All rights reserved. No part of the contents of this manual may be reproduced, copied or transmitted in any form or by any means including graphic, electronic, or mechanical methods or photocopying, recording, or information storage and retrieval systems without the written permission of Despatch Industries, unless for purchaser's personal use.

2. Close all valves and bleed off any pressure.
3. Test for power by attempting a start with the machine controls.
4. Identify the Lockout Condition with a tag on the electrical disconnect and pneumatic shut off valve.
5. When work is complete, remove all tags and restore the machine to its working state.

2.1.2. Door and Panel

The control panel on the LAC-6 Series Oven protect against hazards. Operation without the control panel in place creates hazards that the control panel is intended to render safe for personnel.

	<p>Danger!</p> <p><i>Electrical panels contain high voltage. Disconnect and lock out the power supply before working inside any electrical panels. Failure to lock out the power supply can result in death or injury.</i></p>
---	---

2.2. Maintenance

Only qualified and trained personnel should perform maintenance or repair.

	<p>Warning!</p> <p><i>Do not place this oven in an environment harmful to electrical components.</i></p> <p><i>Placing this oven in an environment detrimental to electrical components (for example, environments where carbon fibers, coal dust or similar contaminants may be present) may result in component failure.</i></p> <p><i>Contact Despatch for options available to help prevent such failures.</i></p>
---	---

2.3. Electrical Power

Only qualified and trained personnel should perform electrical maintenance or electrical repair.

	<p>Danger!</p> <p><i>Contact with energized electrical sources may result in serious injury or death.</i></p>
---	--

- Before performing maintenance, disconnect all electrical power from the machine. Use a padlock and lockout all disconnects feeding power to the machine.
- Never clean, or repair the oven when in operation.
- Unauthorized alterations or modifications to LAC-6 Series Oven are strictly forbidden. Never modify any electrical circuits. Unauthorized modifications can impair the function and safety of the LAC-6 Series Oven.

	<p>Warning!</p> <p><i>Do not place this oven in an environment harmful to electrical components.</i></p> <p><i>Placing this oven in an environment detrimental to electrical components (for example, environments where carbon fibers, coal dust or similar contaminants may be present) may result in component failure.</i></p> <p><i>Contact Despatch for options available to help prevent such failures.</i></p>
--	---

2.4. Fire

Keep the LAC-6 Series Oven clean and free of scrap materials, oil or solvents to prevent the possibility of fire. In the event of fire, use a fire extinguisher as follows.

1. Leave door as it is.
2. De-energize the machine immediately by turning OFF the main power.
3. Shut off fuel (if applicable)
4. Call the fire department or extinguish the fire.

	<p>Danger!</p> <p><i>Always disconnect all power before extinguishing a fire. Attempting to extinguish a fire in a machine connected to electrical power can result in serious injury or death!</i></p>
---	--

Copyright © 2011 by Despatch Industries.

All rights reserved. No part of the contents of this manual may be reproduced, copied or transmitted in any form or by any means including graphic, electronic, or mechanical methods or photocopying, recording, or information storage and retrieval systems without the written permission of Despatch Industries, unless for purchaser's personal use.

2.5. Equipment Lockout Requirements

To prevent injury or equipment damage during inspection or repair, the LAC-6 Series Oven must be locked out.

2.5.1. Emergency Stop

When a risk of personal injury or damage to the LAC-6 Series Oven exists, turn OFF the oven by removing/unplugging the cord. This shuts off all electrical power to the oven.

3. Theory of Operation

3.1. The LAC-6 Series Oven

The LAC-6 high-performance bench-top oven uses digitally-controlled, horizontal recirculating airflow to ensure uniform temperatures throughout the oven for fast-processing (Figure 1). A high-volume fan circulates air through perforated, stainless steel walls to create a constant horizontal airflow across all sections of the oven (Figure 2). The result is proven reliability in demanding production and laboratory applications such as curing, drying, sterilizing, aging and other process-critical procedures.

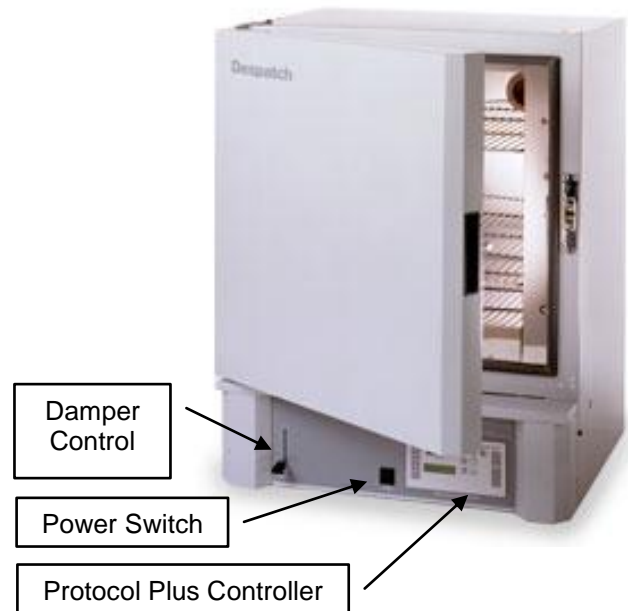

Figure 1. LAC High-performance Bench-top Oven.

The LAC-6 oven is especially useful for testing, preheating, sterilizing, drying, aging and curing along with other production applications. The overall result is efficient productivity under strenuous conditions. The chamber can be densely loaded without interfering with the process. Air delivery temperature is within 1 °C of the number appearing on the digital display. Fresh air intake is regulated by a panel-mounted damper control, while the exhaust opening is fixed. The exhaust port, on the back of the oven, is covered by a hat bracket.

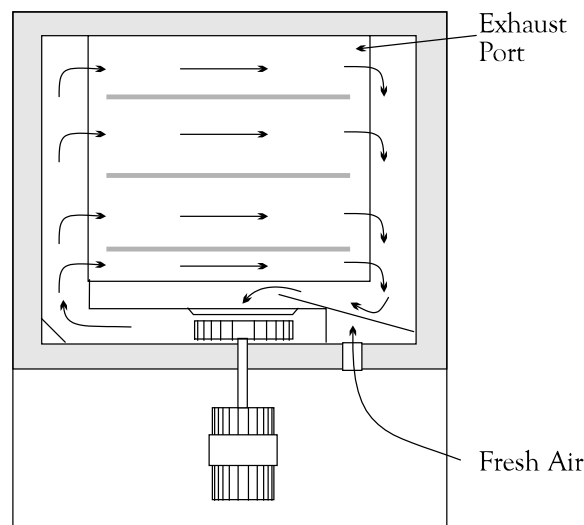

Figure 2. Horizontal Airflow through the LAC Oven.

Copyright © 2011 by Despatch Industries.

All rights reserved. No part of the contents of this manual may be reproduced, copied or transmitted in any form or by any means including graphic, electronic, or mechanical methods or photocopying, recording, or information storage and retrieval systems without the written permission of Despatch Industries, unless for purchaser's personal use.



Warning!

Do not remove the hat bracket (located in rear of oven) as it distributes exhaust air and protects the exhaust opening from being completely covered.

3.2. Damper Control

The LAC-6 oven is equipped with a manually-adjustable damper mechanism. The damper control arm is located on the front panel of the oven (Figure 1). The damper adjustment controls the fresh air opening which, due to pressurization of the oven chamber, controls the flow of exhaust. If the damper is in the full open position, the maximum exhaust rate is achieved. If the damper is in the fully closed position, the minimum exhaust rate is achieved.

3.2.1. Determining Damper Settings

The optimum setting for the damper depends on a variety of factors. These factors include ambient environment temperature, load conditions, load distribution, heat-up and cool-down rates, desired temperature uniformity and most importantly the desired operating temperature. Additionally, engineering tradeoffs for each factor must be carefully weighed. While considering each factor independently may be too daunting, guidelines provide a simpler way to determine damper settings.

In general, set the damper so the amount of fresh air flowing into and exhausting from the chamber agrees with the desired operating temperature conditions. The following outline provides practical considerations for various damper position settings (Figure 3).



Figure 3. Damper Positions.

3.2.1.1. Damper Full-Closed Position

The damper in full-closed position allows maximum attainable heat-up rates for the chamber. In addition, the chamber uses minimum power to operate at the desired temperature. In most cases, maintain the damper in the full-closed position to efficiently operate at the maximum operating temperature for the chamber.

3.2.1.2. Damper Full-Open Position

The damper in full-open position allows minimum operating temperature for the chamber. Friction heat from the air recirculation system builds up in the chamber. This causes chamber temperature to rise slightly though the heating system is not ON. After

Copyright © 2011 by Despatch Industries.

All rights reserved. No part of the contents of this manual may be reproduced, copied or transmitted in any form or by any means including graphic, electronic, or mechanical methods or photocopying, recording, or information storage and retrieval systems without the written permission of Despatch Industries, unless for purchaser's personal use.

the recirculation motor has been ON for an extended period of time, the chamber reaches a thermal equilibrium temperature.

When the damper is not set to full-open position, the chamber has no way to readily dissipate the heat generated by the friction. With the damper fully open, the thermal equilibrium temperature is the minimum operating temperature of the chamber.

	<p><i>When the damper is in the full-open position, the oven may not be able to heat to the maximum oven operating temperature.</i></p>
---	--

3.2.1.3. Other Damper Settings

The damper can be set to several other distinct operating positions. In most cases the damper setting is influenced by two specific performance factors: uniformity and cool-down rates.

Chamber Uniformity

The system's inside chamber pressure influences chamber uniformity. Pressure inside the chamber depends on the amount of fresh air flowing into the chamber. When a large volume of fresh air flows into the chamber, the chamber pressurizes slightly and overall temperature uniformity improves. The slightly pressurized chamber produces the effect of "pushing" air to the corners of the chamber. Typically the corners of the chamber improve with respect to temperature distribution while the core of the chamber maintains excellent uniformity characteristics regardless of damper position.

Pressurization of the chamber typically is a factor when the chamber is loaded heavily. The best uniformity results, with respect to the product, are achieved when no more than two-thirds of any inside chamber dimension are used. The best overall results are achieved when the product(s) are located in the center of the chamber.

Cool-Down Rates

The more open the damper, the faster the cool-down.

	<p><i>Over-pressuring the chamber can cause hot air to blow out around the door seal and cause the area around the door to be hot to the touch. Eliminate this hot air from entering the room by closing the damper slightly until the air stops blowing.</i></p>
---	--

3.3. The Protocol Plus Controller

The Protocol Plus controller has two displays. A dedicated LED upper display shows the oven temperature (Figure 4). A two line LCD lower display provides information on control status, high limit temperature and allows changes to be made to the control settings. Review the Protocol Plus Controller Owner's Manual for more information.

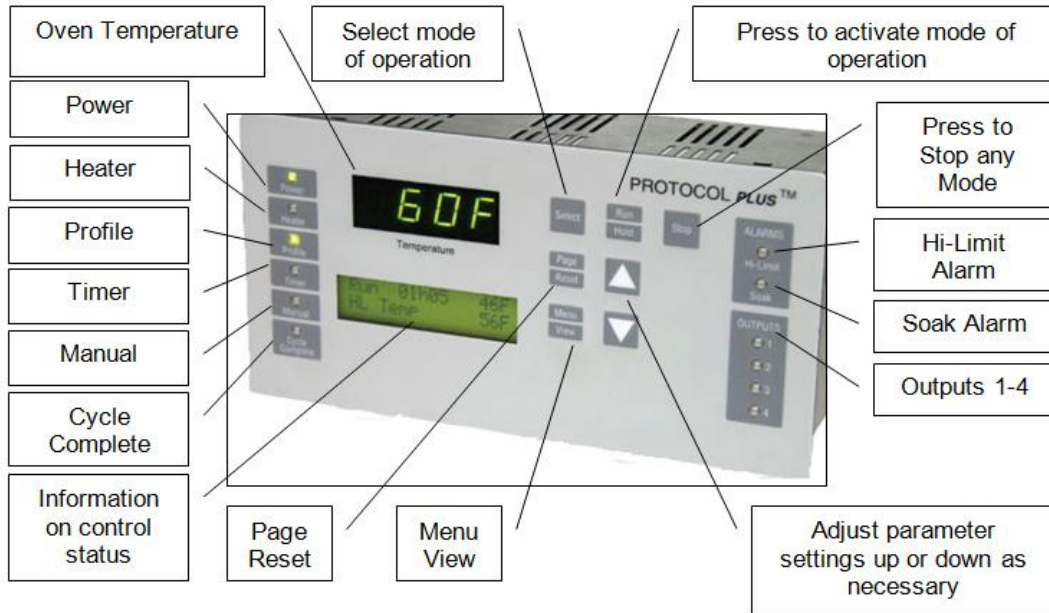

Figure 4. Protocol Plus Displays and Control Buttons.

4. Assembly & Setup

Assembly and Setup provides directions for unpacking and installing your LAC-6 Series Oven.

4.1. Unpack & Inspect the LAC-6 Series Oven

Remove all packing materials and thoroughly inspect the oven for any damage that might have occurred during shipment.

- Note whether the carton and plastic cover sheet inside carton are still in good condition
- Observe all outside surfaces and corners of the oven for scratches and dents
- Check oven controls and indicators for normal movement, bent shafts, cracks, chips or missing parts such as knobs and lenses
- Check the door and latch for smooth operation

4.1.1. If Damaged During Shipping

If damage occurred during shipping:

1. Contact the shipper immediately and file a written damage claim.
2. Contact Despatch Industries (1-800-473-7373 or 1-952-469-8230 or service@despatch.com) to report your findings and to order replacement parts for those damaged or missing. Send a copy of your filed damage claims to Despatch industries (Despatch Industries, 8860 207th Street, Lakeville, MN 555044, USA).
3. Check the packing list to ensure you received all the specified components of the oven system. If any items are missing, contact Despatch Industries to have missing products forwarded to you. Your shipment should include:
 - One (1) Despatch oven
 - One (1) Instruction manual and Protocol Plus Manual
 - One (1) Warranty card
 - Two (2) Shelves
4. Complete the warranty card and mail it to Despatch within 15 days after receipt of the equipment.

4.2. Set-up the LAC-6 Series Oven

4.2.1. Select Oven Location/Operating Environment

The Despatch LAC-6 Series oven is designed to operate in an industrial setting. Despatch recommends the following environmental operating guidelines:

1. Place the oven on a flat, level solid foundation

Copyright © 2011 by Despatch Industries.

All rights reserved. No part of the contents of this manual may be reproduced, copied or transmitted in any form or by any means including graphic, electronic, or mechanical methods or photocopying, recording, or information storage and retrieval systems without the written permission of Despatch Industries, unless for purchaser's personal use.

2. Do not expose the oven to excessive external vibration
3. Do not remove electrical cabinet covers
4. Where excessive particulate matter is present, such as on a construction site or coal processing, Despatch recommends periodic (usually monthly) cleaning of all electrical compartments.
5. Ensure the power supply meets Despatch specifications. If the facility power supply is not stable, Despatch recommends a line conditioner.

4.2.2. Set-up Procedure

	<p>Warning!</p> <p><i>All grounding and safety equipment must be in compliance with applicable codes, ordinances and accepted safe practices.</i></p>
---	--

	<p>Warning!</p> <p><i>Do not use the oven in wet, corrosive or explosive atmospheres unless this oven is specifically designed for a special atmosphere.</i></p>
--	---

1. Place oven on bench top or optional cabinet base.
 - a. Ensure a minimum of two (2) inches (5.1 cm) clearance in the rear of oven to provide proper ventilation. The oven may be placed next to another cabinet, or next to another oven, with three (3) inch (7.6 cm) clearance (the doors will still open).
 - b. Ensure oven is level and plumb for proper heat distribution and operation of all mechanical components.
2. Identify correct power source indicated on the specification nameplate.
3. Plug or hardwire oven directly to the electric supply.

4.2.3. Wiring & Power Connections

	<p><i>Read the Model LAC-6 name plate (top of oven or top of control area under the door) for proper power requirements before proceeding with wiring and power connections (Figure 5).</i></p>
---	---

	<p>Danger!</p> <p><i>All grounding and safety equipment must be in compliance with applicable codes, ordinances and accepted safe practices.</i></p>
---	---

Models LAC 1-10, 1-38A, 1-38B, and 1-67 come equipped with an appropriate plug and cord. Models LAC 2-12 and 2-18 must be hardwired to the electric supply using 10 AWG or larger wires suitable for at least 75 °C (167 °F).



Figure 5. LAC-6 Series Oven Nameplate.

4.2.3.1. Wire LAC-6 Models 2-12 and 2-18

	<p><i>For units that must be hardwired or where a power cord is shipped loose, run the power lines from the rear of the oven to the front control panel.</i></p>
---	--

1. Open the knock-out near the rear-access panel (Figure 6).

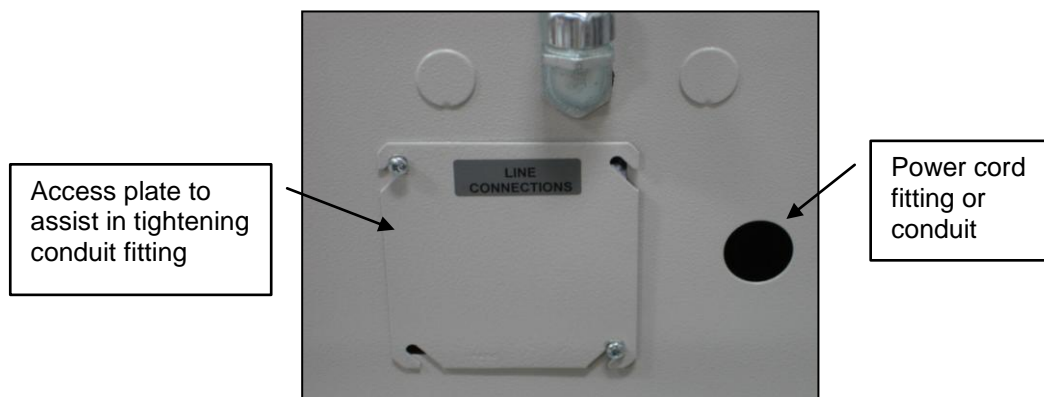

Figure 6. Rear Access Panel for Hard-Wired Connections.

2. Turn hinged front panel latches $\frac{1}{4}$ turn for easy access to access power connection (Figure 7).



Figure 7. Hinged Panel for Simpler Access to Power Connections.

3. Connect power at main circuit board (access by opening hinged control panel), terminals L1 and L2 (Figure 8).
 - a. Tighten terminals on the circuit board to 10.6 to 13.2 lb-in (1.2 to 1.5 nM)
 - b. Attach the ground wire to the ground buss on the panel.
 - c. Close hinged control panel after attaching the power supply wires or cord.

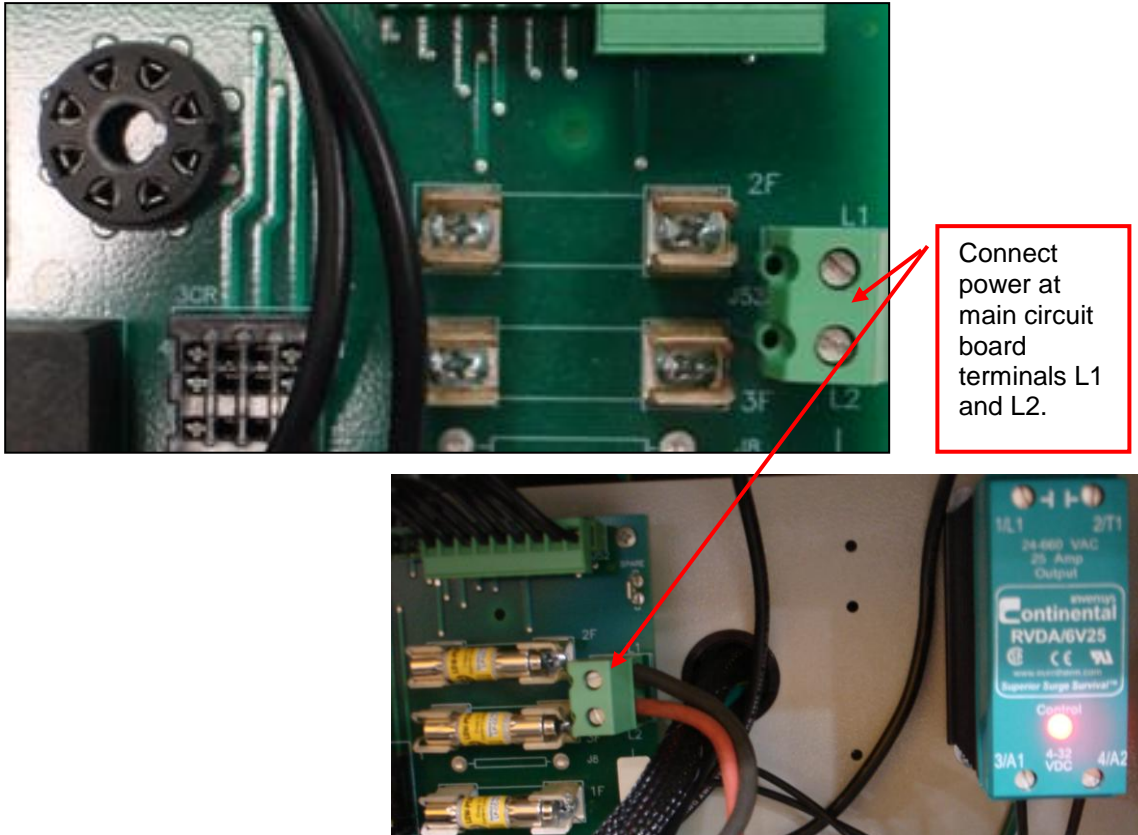

Figure 8. Power Connections at Main Circuit Board.

4.3. MRC5000 Setup (Optional)



Refer to instructions provided recorder manufacturer for more specific installation notes.

Temperature is retransmitted to the MRC5000 recorder from the controller. Set up the recorder by:

1. Ensure hardware jumper JU1 is in place for the 5 VDC setting (Refer to MRC5000 Manual included).
2. Move **Mode** to **PROG/TEST/CAL** to display **Prog**.
3. Press **▼** twice to display **Inps**. Move to each Parameter Code using **▼** or **▲**. Adjust each Parameter Code using the settings in Table 2.
4. After adjusting all settings, move **Mode** to **RUN**. Display on both the Recorder and controller should read the same.

Table 1. MRC 5000 Settings.

Parameter Code	Degrees C	Degrees F
Inps	18	18
Icor	0	0
diSP	On	On
dPOS	0	0
EUU**	400	752
EUL**	0	32
ChUP	400	800*
ChLO	0	0
DFF	1	1

* Change 0-400 chart paper to 0-800 chart paper. Depending on the equipment used, 0-600 paper may be used if the maximum temperature is 500 degrees F.

** These values must match the settings **RetOutLo** and **RetOutHi** on the Protocol Plus Control page. For example, if **RetOutLo** is 32, **EUL** must read 32.

5. Operation

	<p><i>Users and operators of this oven must comply with operating procedures and training of operating personnel as required by the Occupational Safety and Health Act (OSHA) of 1970, Section 5 and relevant safety standards, and other safety rules and regulations of state and local governments. Refer to the relevant safety standards in OSHA and National Fire Protection Association (NFPA), Section 86 of 1990.</i></p>
---	--

	<p>Warning!</p> <p><i>Do not use the oven in wet, corrosive or explosive atmospheres unless this oven is specifically designed for a special atmosphere.</i></p>
---	---

5.1. Load Oven

	<p><i>Despatch Industries cannot be responsible for either the process or process temperature used, or for the quality of the product being processed. It is the responsibility of the purchaser and operator to see that the product undergoing processing in a Despatch oven is adequately protected from damage.</i></p> <p><i>Carefully following the instructions in this manual will help the purchaser and operator in fulfilling that responsibility.</i></p>
---	---

Avoid spilling on the heater elements or oven floor when loading the oven. Do not place the load on the oven floor plate. Placing the load on the oven floor may cause the load to heat unevenly and the weight may cause shorting out of the heater elements. Use the shelves provided.

	<p>Caution!</p> <p><i>Always place loads on the shelves provided to avoid possible uneven heating and damage to the oven.</i></p>
---	--

Copyright © 2011 by Despatch Industries.

All rights reserved. No part of the contents of this manual may be reproduced, copied or transmitted in any form or by any means including graphic, electronic, or mechanical methods or photocopying, recording, or information storage and retrieval systems without the written permission of Despatch Industries, unless for purchaser's personal use.

The two shelves are designed to be pulled out about halfway without tipping. Do not overload the shelves (Refer to Support Capacity listed in Section 1.5.2). Distribute the workload evenly so airflow is not restricted. Do not overfill your oven. The workload should not take up more than two-thirds of any dimension of the inside cavity.

5.2. Pre-Startup Checklist

	<p>Warning!</p> <p><i>Do not use flammable solvent or other flammable material in this oven. Do not process closed containers of any substance or liquid in this oven because they may explode under heat.</i></p>
---	---

- Know the system. Read this manual carefully. Make use of its instructions and explanations. Safe, continuous, satisfactory, trouble-free operation depends primarily on your degree of understanding the system and your willingness to keep all parts in proper operating condition.
- Check line voltage. Voltage must correspond to nameplate requirements of motors and controls. A wrong voltage can result in serious damage. Refer to Section 1.5.4 for more information.
- Check fresh air and exhaust openings. Do not be careless about restrictions in and around the fresh air and exhaust openings and stacks. Under no condition can they be permitted to become so filled with dirt that they reduce airflow.
- Ventilation. An exhaust opening in the rear of the unit is covered by a hat bracket. Do not remove the hat bracket as it protects the exhaust opening from being completely covered.
- Helpful hints:
 - For drying ovens, open vent to prevent buildup of moisture.
 - For sample heating, close vent when no ventilation is required.

5.3. Operating Procedure



For fastest oven heat-up time, close the fresh-air vent. After the desired temperature is reached, the vent may be adjusted as needed.

5.3.1. Start Oven

1. Start fan
 - a. Open oven door
 - b. Press Power Switch to ON (Figure 1). Listen for the recirculating fan to start.
 - c. Shut oven door
 - d. Check that control display turns ON.
2. Operate temperature control as desired by following the control operation instructions to follow.

5.3.2. Working with Protocol Plus Operating Modes

Refer to the Protocol Plus Controller Owner's Manual for specifics on working with the controller.

6. Maintenance

	<p>Warning!</p> <p><i>Do not attempt any service on this oven before opening the main power disconnect switch.</i></p>
---	---

	<p>Warning!</p> <p><i>Do not place this oven in an environment harmful to electrical components.</i></p> <p><i>Placing this oven in an environment detrimental to electrical components (for example, environments where carbon fibers, coal dust or similar contaminants may be present) may result in component failure.</i></p> <p><i>Contact Despatch for options available to help prevent such failures.</i></p>
---	---

6.1. Checklist

- **Keep equipment clean.** Gradual dirt accumulation retards airflow. A dirty oven can result in unsatisfactory operation such as unbalanced temperature in the work chamber, reduced heating capacity, reduced production, overheated components, and the like. Keep the walls, floor and ceiling of the oven work chamber free of dirt and dust. Floating dust or accumulated dirt may produce unsatisfactory work results. Keep all equipment accessible. Do not permit other materials to be stored or piled against it.
- **Protect controls against excessive heat**—particularly controls, motors or other equipment containing electronic components. Temperatures greater than 51.5°C (125°F) should be avoided.
- **Establish maintenance and checkup schedules.** Do this promptly and follow the schedules faithfully. Careful operation and maintenance will be more than paid for in continuous, safe and economical operation.
- **Maintain equipment in good repair.** Make repairs immediately. Delays may be costly in added expense for labor and materials and in prolonged shut down.
- **Practice safety.** Make it a prime policy to know what you are doing before you do it. Make **caution, patience, and good judgment** the safety watchwords for the operation of your oven.

Copyright © 2011 by Despatch Industries.

All rights reserved. No part of the contents of this manual may be reproduced, copied or transmitted in any form or by any means including graphic, electronic, or mechanical methods or photocopying, recording, or information storage and retrieval systems without the written permission of Despatch Industries, unless for purchaser's personal use.

6.2. *Lubrication*

Fan motor bearings are permanently lubricated. All door latches, hinges, door operating mechanisms, bearing or wear surfaces should be lubricated to ensure easy operation.

6.3. *Routine Tests*

Test LAC-6 Series Oven functions regularly and carefully for best performance. Safety of personnel and maintenance of your equipment may depend on the proper operation of any of the temperature control functions.

- Check that the heater LED is cycling on and off, indicating the heater is working.
- Check the high limit function to make sure it is working properly:
 1. Press **Select** and go to Manual Mode. Enter a control setpoint value at least 20°F (11°C) lower than the current process temperature.
 2. Press **Menu** and lower the high limit setpoint to a value just below the current process temperature.
 3. Press **Run**
 4. The high limit alarm indicator will flash and a high limit alarm message will display.
 5. Press **Stop**.
 6. Press **Reset**.
 7. Return the control setpoint and high limit setpoint values to their original values.

6.4. *Door Adjustment*

To increase or decrease latch tension, or to gain a better door seal on the latch side:

- Turn the door strike in or out on its threads by loosening the allen head set screw.
- If necessary, adjust the vertical alignment of the strike to increase or decrease latch tension.
 1. Loosen the two screws on the latch strike and sliding the strike up or down on its slots
 2. After positioning the strike, tighten the screws.

6.5. *Replacement Parts*

To order or return parts, contact Despatch Service & Technical Support. When returning parts, a Despatch representative will provide an MRA (Material Return Authorization) number. Attach the MRA number to the returned part for identification. When ordering parts, expedite the process by giving the model number, serial number and part number.

Global Headquarters	Contact	Service & Technical Support
Despatch Industries 8860 207th Street Lakeville, MN 55044 USA	International/Main: 1-952-469-5424 US toll free: 1-888-337-7282 Fax: 1-952-469-4513 info@despatch.com www.despatch.com	Service: 1-952-469-8230 US toll free: 1-800-473-7373 Fax: 1-952-469-8193 Service @despatch.com

	<p>Warning!</p> <p><i>Disconnect the main power switch or power cord before attempting any repair or adjustment.</i></p>
---	---

6.5.1. Replace the Protocol Plus Controller

Refer to the Protocol Plus Owner's Manual for instructions on replacing the Protocol Plus Controller.

6.5.2. Replace Heater Unit

Tools needed: 3/8" wrench,
T20 Torx bit driver

1. Remove the floor plate.
 - a. Remove the screws from the floor plate (Figure 9).



Figure 9. Remove Screws to Remove Floor Plate.

- b. Lift the floor plate out of the oven to expose heater panel/inlet cone (Figure 10).



Figure 10. Heater Panel and Inlet Cone.

Copyright © 2011 by Despatch Industries.

All rights reserved. No part of the contents of this manual may be reproduced, copied or transmitted in any form or by any means including graphic, electronic, or mechanical methods or photocopying, recording, or information storage and retrieval systems without the written permission of Despatch Industries, unless for purchaser's personal use.

2. Remove side walls by removing the screws on the front edge of each panel (Figure 11).
3. Disconnect the heater leads from heater element with wrench.

	<p><i>Before disconnecting leads, carefully diagram (or note) which wires connect to which terminals.</i></p>
---	--

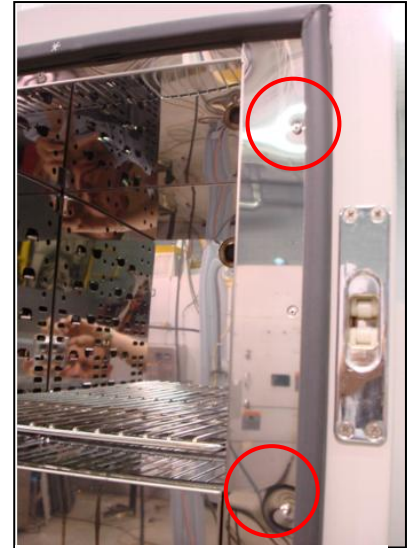

Figure 11. Remove Screws to Remove Side Panels.

4. Unscrew the screws holding the heater frame to the oven body (Figure 12).
5. Remove heater and discard.
6. Screw down the new heater frame.
7. Attach the heater leads to appropriate terminals.
8. Replace and screw in interior floor and side panels.

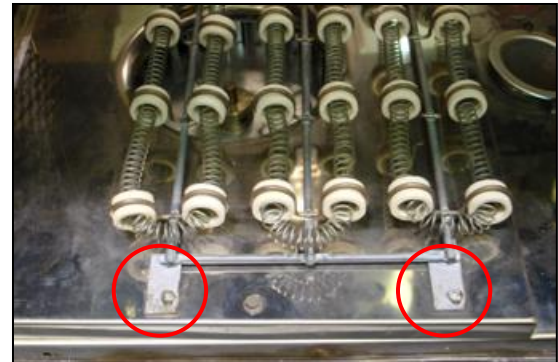

Figure 12. Remove Heater Panel by Removing Screw in Front Edge of Each Panel.

6.5.3. Replace Fan Motor

Tools needed: T20 Torx bit driver, 5/32 inch Allen wrench, one quarter (1/4) inch socket set

1. Remove the floor plate.
 - a. Remove the screws from the floor plate (Figure 9).
 - b. Lift the floor plate out of the oven to expose heater panel/inlet cone (Figure 10).
 - c. Lift the floor plate out of the oven to expose heater panel/inlet cone (Figure 10).
2. Remove side walls by removing the screws on the front edge of each panel (Figure 11).
3. Disconnect the heater leads from heater element with wrench.



Before disconnecting leads, carefully diagram (or note) which wires connect to which terminals.

4. Unscrew the screws holding the heater frame to the oven body (Figure 12).
5. Unplug the motor harness from the circuit board and remove motor and heater ground wires from ground stud.
6. Unplug heater leads from circuit board and thermocouple leads from control.
7. Pull off fresh air damper handle from damper arm.
8. Remove screws holding fresh air damper arm assembly to control panel.
9. Remove the chamber floor plate.
 - a. Remove the screws from the floor plate.
 - b. Lift the floor plate out of the oven.
10. Remove the left side wall.
11. Remove fan and heater plug assembly from oven by lifting on the air outlet of the assembly and pushing from underneath.
12. Remove heater (do not disconnect wires).
13. Remove the fan inlet plate.
14. Loosen the set screws (2) on fan wheel and remove wheel.
15. Remove the screws (4) holding the fan motor in place.
16. Remove the fan motor.
17. Install the fan motor.
 - a. Insert shaft seal onto shaft.
 - b. Insert the shaft into shaft collar.
 - c. Fasten motor to plug assembly with the four screws.
18. Install fan wheel onto motor shaft.
19. Replace and fasten the fan inlet cover.
20. Adjust the fan wheel for 3/16 inch clearance between the wheel and the inlet ring and tighten the set screws on the fan wheel. Check that the set screws hit the flats machined into the motor shaft.
21. Replace and fasten heater.
22. Replace fan and heater plug assembly in oven body.
23. Replace left side wall.
24. Replace and fasten floor plate.
25. Replace fresh air damper arm assembly.
26. Replace fresh air damper handle.
27. Connect heater leads to circuit board.
28. Connect motor wire harness and fasten motor and heater ground wires to ground stud.
29. Connect thermocouple wires to control.
30. Replace control panel in oven body.

7. Troubleshooting

7.1. Troubleshooting Error Messages and Alarms

Table 3 lists the more common error messages, the possible problems and remedies.

Table 2. Error Messages and Next Steps.

Alarm Status	Possible Problem	Next Step
Hi-Limit LED flashing	<ul style="list-style-type: none"> • Problem with thermocouple • Hi-limit setpoint has been exceeded. 	Once the problem has corrected, press Reset .
Soak LED flashing	Oven temperature has not entered (or dropped out of) the soak band and the soak timer has stopped	Program a slower ramp rate or if oven is not heating check heater circuit.
Top LED displays OPEN and lower LCD displays CONTROL SENS ERR	Control thermocouple is disconnected or broken	Repair or replace the thermocouple.
Lower LCD displays HI LIM SENS ERR	Hi limit thermocouple is disconnected or broken	Repair or replace the thermocouple.
Lower LCD displays HIGH LIMIT ALARM	Hi limit temperature setpoint has been exceeded	Determine if: <ul style="list-style-type: none"> • the setting is too close to the setpoint • the SSR is defective • calibration is incorrect

	<p><i>The lower LCD intermittently display HL Temp. This is not an error message, but the Hi limit thermocouple temperature reading.</i></p>
---	--

7.2. Troubleshooting Symptoms

Table 4 lists symptoms, probably causes and suggested remedies.

	<p><i>The circuit board mounted on the control panel has three status LED indicators to help troubleshoot if the oven is not heating:</i></p> <ul style="list-style-type: none"> ▪ <i>If LED 1 is not lit, check 2F and 3F (control fuses), or power switch.</i> ▪ <i>If LED 1 and LED 3 are lit but not LED 2, check high limit (and optional door switch, if installed).</i> ▪ <i>If all three LEDs are lit, check 1F and 4F (heater fuses), SSR, heater, and heater relays.</i>
---	---

Table 3. Troubleshooting Oven Symptoms.

Symptom	Possible Cause	Next Step
Failure to heat or heats to only 35-50 degrees C	No power	Check power source and/or oven and wall fuses
	Broken or frayed cord	Replace with new cord
	Burned out heater	Replace heater (see Warranty Section 8.1)
	Protocol™ malfunction	Replace controller
	Loose wire connections	Disconnect power and check connections behind control panel
	Heater relay failure	Replace circuit board
	Door switch failure	Replace door switch
Slow heat-up	Improperly loaded	Reduce load or redistribute load in chamber
	Low line voltage	Supply sufficient power and proper connections. Check for circuit overload
	Heating element(s) are burned out	Replace burned out element (see Warranty Section 8.1)
	240 volt oven is connected to a 208V line	Raise line voltage to a 240 volt line or modify oven for 208V operation (consult factory)
	Fan motor failure	Replace fan motor
Frequent heater element out	Harmful fumes generated by load	Increase vent opening or discontinue process
	Spillage or splattering of material on heater elements	Disconnect power and clean oven chamber and elements
	Overheating oven	Check the Hi-limit
Erratic or inaccurate temperature	Protocol™ Plus Controller malfunction	Replace Protocol™ Plus Controller
	Improper tuning parameters	Check tuning parameters
	Protocol™ Plus Controller miscalibration	Recalibrate Protocol™ Plus Controller (See Protocol Plus Owner's Manual, sections on Calibration)
	Hi-limit setting	Hi-limit should be 10-25°C higher than setpoint
	Improper offset	Check zone calibration
Excess surface or door temperature	Door seal deterioration	Replace door seal
Improper airflow	Fan motor failure	Replace fan motor
	Fan wheel seated too low on fan shaft	Adjust fan wheel for 3/16" clearance between wheel and inlet ring
	Unbalanced fan wheel	Replace fan wheel
Excessive vibration	Dirty fan wheel	Clean fan
	Unbalanced fan wheel	Replace fan wheel
Oven will not control at setpoint	Hi-limit set too low	Set the Hi-limit higher
	Protocol malfunction	Replace control
	SSR malfunction	Replace SSR and/or check control output voltage
	Air friction of recirculation fan	Open exhaust air vent. Unit will not control below minimum operating temperature with vent closed
Heater does not shut down until temp. reaches the Hi-limit setting	Protocol malfunction	Replace Protocol
	SSR malfunction	Replace SSR

8. Appendices

8.1. Standard Products Warranty



Despatch
INDUSTRIES

Standard Products Product Warranty

Products Covered by this Warranty

This warranty (the "warranty") applies to the following Despatch products: LEB, LBB, LAC, LCC, LCD, LLD, RAD, RFD, LND, RTFO, TAD, TFD, PR, PN, PW, PTC and the following Ransco products: RTH, RTS, 900 Series.

Parts and Materials

Despatch warrants all parts and materials to be free from defects in material and workmanship for a period of:

- Five (5) years from date of shipment for laboratory oven electric heaters.
- Three (3) years from the date of shipment for Protocol Plus and DES 2000 temperature controllers; and
- One (1) year from the date of shipment, or 2,000 hours of operation, whichever occurs first, for all other components of products covered by this Warranty.

During the applicable Warranty period, Despatch will repair or replace, at Despatch's option, parts and materials covered by this Warranty.

Labor

During the first 90 days of the Warranty period, Despatch will pay labor costs incurred to remove defective parts and materials, and to reinstall repaired or replacement parts or materials; provided, however, that Despatch's obligation to pay such labor costs shall be subject to the limitation that the removal and/or reinstallation service must be performed by a Despatch-authorized technician from Despatch's worldwide network of factory-trained professionals at a location within the contiguous United States.

Transportation Costs

All transportation costs to transport defective parts or materials to Despatch and to transport repaired or replacement parts or materials to Customer shall be the responsibility of Despatch.

Terms and Conditions

This Warranty shall be deemed valid and binding upon Despatch if and only if the Customer:

- Installs, loads, operates, and maintains the covered product supplied hereunder in accordance with the instruction manual provided upon delivery and product labeling affixed to the subject equipment;
- If applicable, follows the Emergency Procedure set forth in this Warranty; and
- Contacts Despatch's Helpline at 1-800-473-7373 for assistance in diagnosing and troubleshooting the problem immediately upon discovering any damage or malfunction.

Despatch's reasonable determination as to whether a repair, replacement, or service is covered by this Warranty shall be final and binding.

Exclusions

This Warranty DOES NOT cover,

- Damage or malfunctions, or expenses incurred in the process of diagnosing and/or repairing damage or malfunctions, resulting from any of the following: operator error, misuse, abuse, inadequate preventative maintenance, normal wear and tear, service or modifications by other than Despatch authorized technicians, use of the covered product that is inconsistent with the operation manual or labeling, acts of nature (including, without limitation, floods, fire, earthquake, or acts of war or civil emergency), internal or external corrosion, or non-conforming utilities (including, without limitation, electrical, fuel supply, environmental and intake/exhaust installations);
- Repair or replacement of parts or materials designed and intended to be expendable or consumable; refrigerants, filters, lamps;
- Routine maintenance; or
- Labor costs incurred for troubleshooting, diagnostics, or testing (except for testing required to verify that a covered defective part or material has been repaired).

Limitations of Liability

Despatch shall not, in any event, be liable for indirect, special, consequential, incidental, or punitive damages or penalties of any kind, including without limitation loss of revenue, profits or business opportunities resulting from interruption of process or production. In no event shall Despatch be liable for damages in excess of the amounts paid by Customer to Despatch with respect to the applicable product(s). This Warranty does not cover, and Despatch shall not be liable for any losses, costs, damages or expenses resulting from delays in diagnosing or repairing the products, supplying or obtaining replacement parts of materials, strikes, labor stoppages or shortages, fires, accidents, government acts or regulations, or any other causes beyond the control of Despatch.

Non-Compliance By Customer

Despatch reserves the right to suspend and withhold service under this Warranty in the event of non-compliance by the Customer to any terms and conditions of this Warranty or the applicable purchase order or invoice. Further, Despatch shall not be liable for any loss of production, expenses, and inconveniences incurred due to such suspension.

Customer Furnished Equipment Warranty Limitation

This Warranty does not cover diagnosis or repairs of defects in or caused by, lack of performance of, or fitness for purpose of customer-supplied parts or equipment unless specifically noted in the Despatch written order acceptance confirmation.

Performance Commitment

Despatch provides no guarantee of process performance or fitness for purpose, unless specifically noted otherwise in Despatch written order acceptance confirmation. Despatch is providing equipment with design parameters specific only to its equipment.

Procedure Upon Discovery of Defects and Emergencies

In the event Customer becomes aware of any defect in the application products, Customer must immediately: (a) shut off fuel or energy supply (gas and electricity); (b) call for emergency assistance, if needed, and (c) notify Despatch Service.

THE REPRESENTATION AND WARRANTIES SET FORTH HEREIN ARE EXCLUSIVE AND IN LIEU OF, AND CUSTOMER HEREBY WAIVES AND DISCLAIMS RELIANCE UPON, ALL OTHER REPRESENTATIONS AND WARRANTIES OF EVERY KIND WHATSOEVER WHETHER EXPRESS OR IMPLIED, OR ARISING BY OPERATION OF LAW OR IN EQUITY, OR BY COURSE OF PERFORMANCE OR DEALING OR USAGE OF TRADE, INCLUDING, WITHOUT LIMITATION, ANY IMPLIED WARRANTIES OF MERCHANTABILITY OR OF FITNESS FOR A PARTICULAR PURPOSE.

THIS WARRANTY IS PERSONAL TO THE CUSTOMER AND MAY NOT BE TRANSFERRED OR ASSIGNED. ALL LIMITATIONS HEREUNDER, HOWEVER SHALL BE BINDING ON ALL SUCCESSORS AND ASSIGNS OF CUSTOMER.

Service
Worldwide Phone 952-469-8230; Worldwide Fax 952-469-8193; North American Phone 800-473-4373
e-mail service@despatch.com; www.despatch.com

Please see reverse side for other service offerings

8.2. *Electrical Schematics*

The following pages contain electrical schematics and data for the LAC1-10-6,-LAC1-38A-6, LAC1-38B-6,-LAC1-67-6, LAC2-12-6 and LAC2-18-6 ovens.

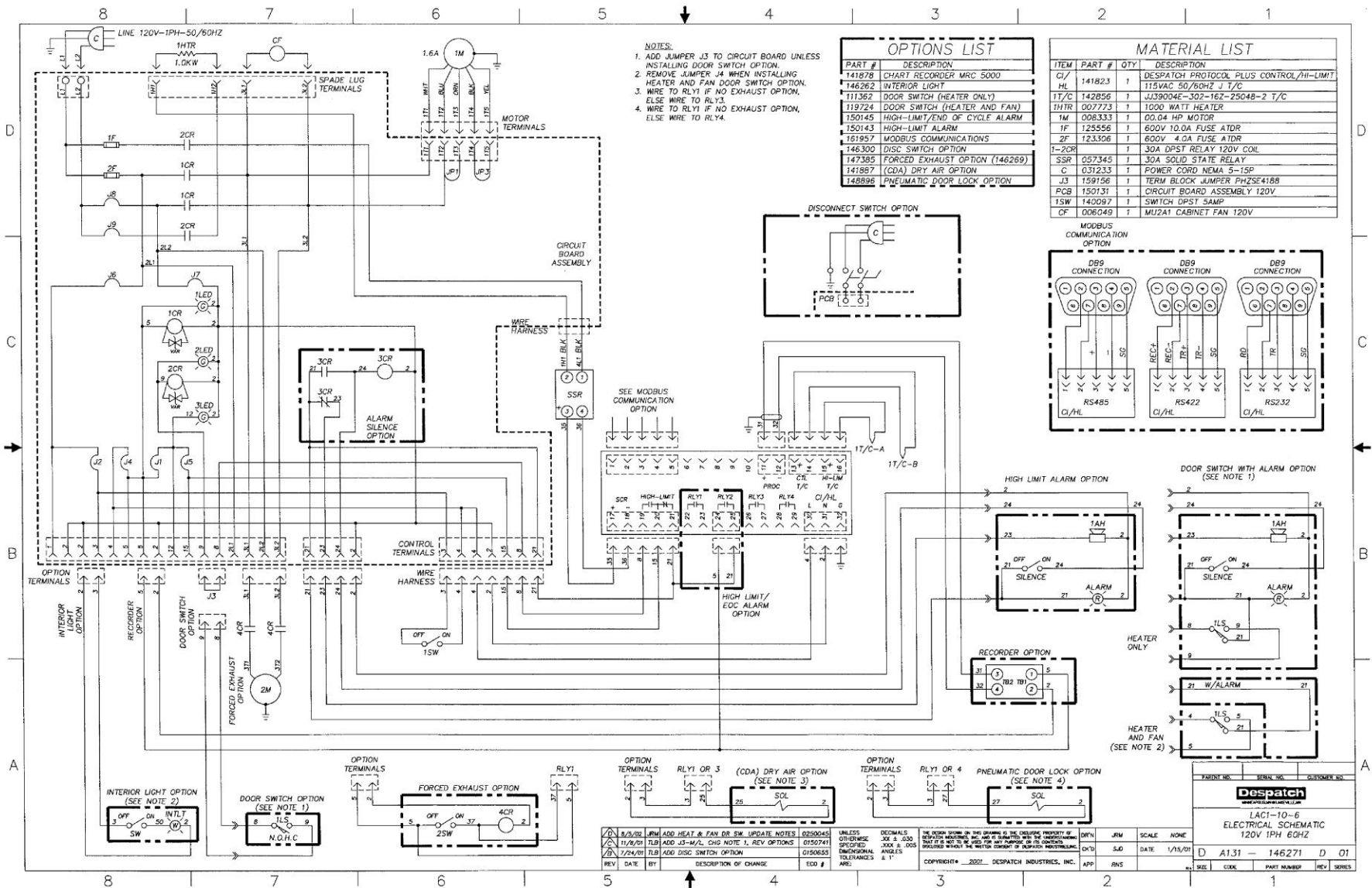

Figure 13. LAC1-10-6 (Excerpt from drawing 146271D01).

Copyright © 2011 by Despatch Industries.

All rights reserved. No part of the contents of this manual may be reproduced, copied or transmitted in any form or by any means including graphic, electronic, or mechanical methods or photocopying, recording, or information storage and retrieval systems without the written permission of Despatch Industries, unless for purchaser's personal use.

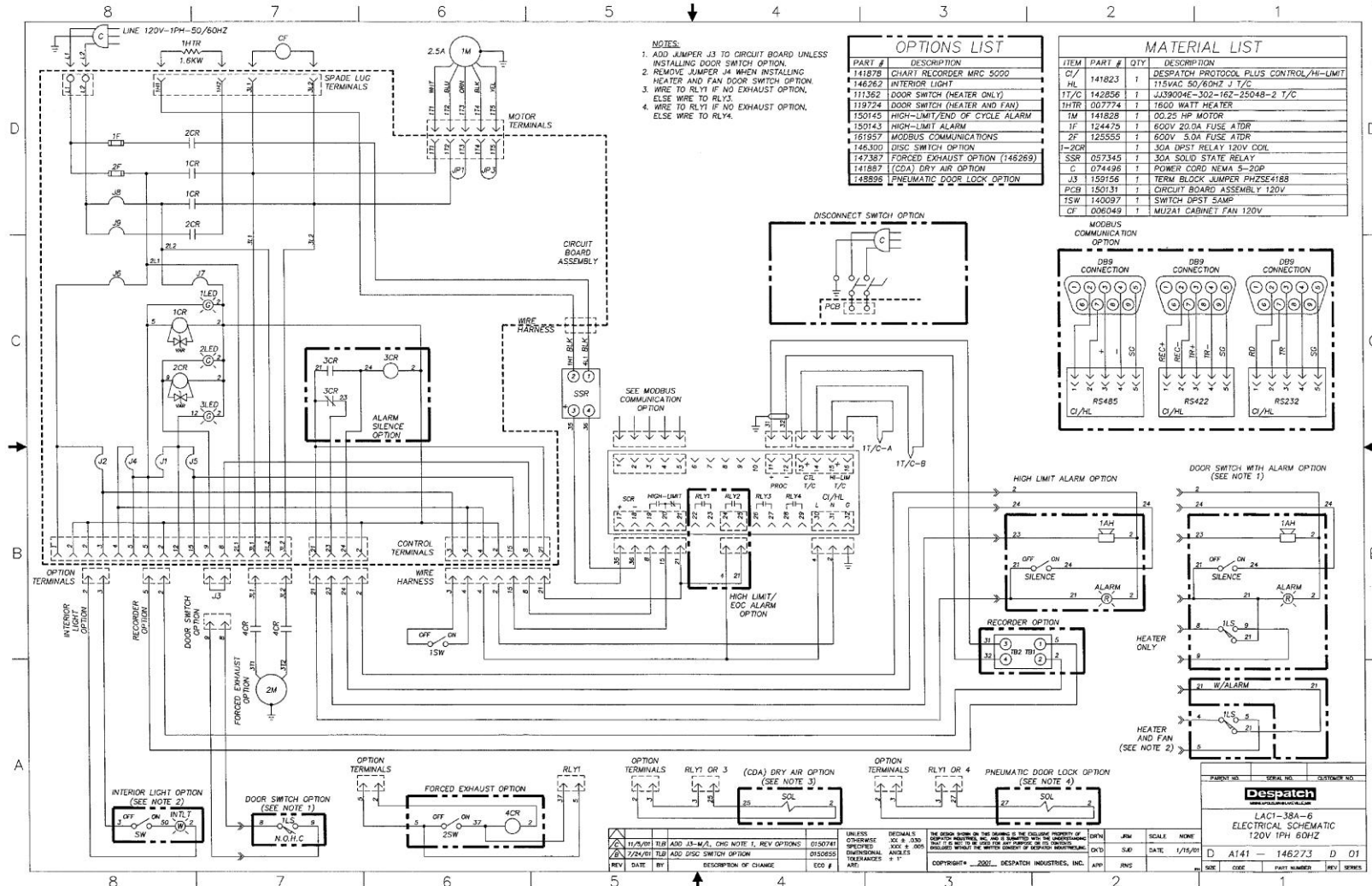

Figure 14. LAC1-38A-6 (Excerpt from drawing 146273D01).

Copyright © 2011 by Despatch Industries.

All rights reserved. No part of the contents of this manual may be reproduced, copied or transmitted in any form or by any means including graphic, electronic, or mechanical methods or photocopying, recording, or information storage and retrieval systems without the written permission of Despatch Industries, unless for purchaser's personal use.

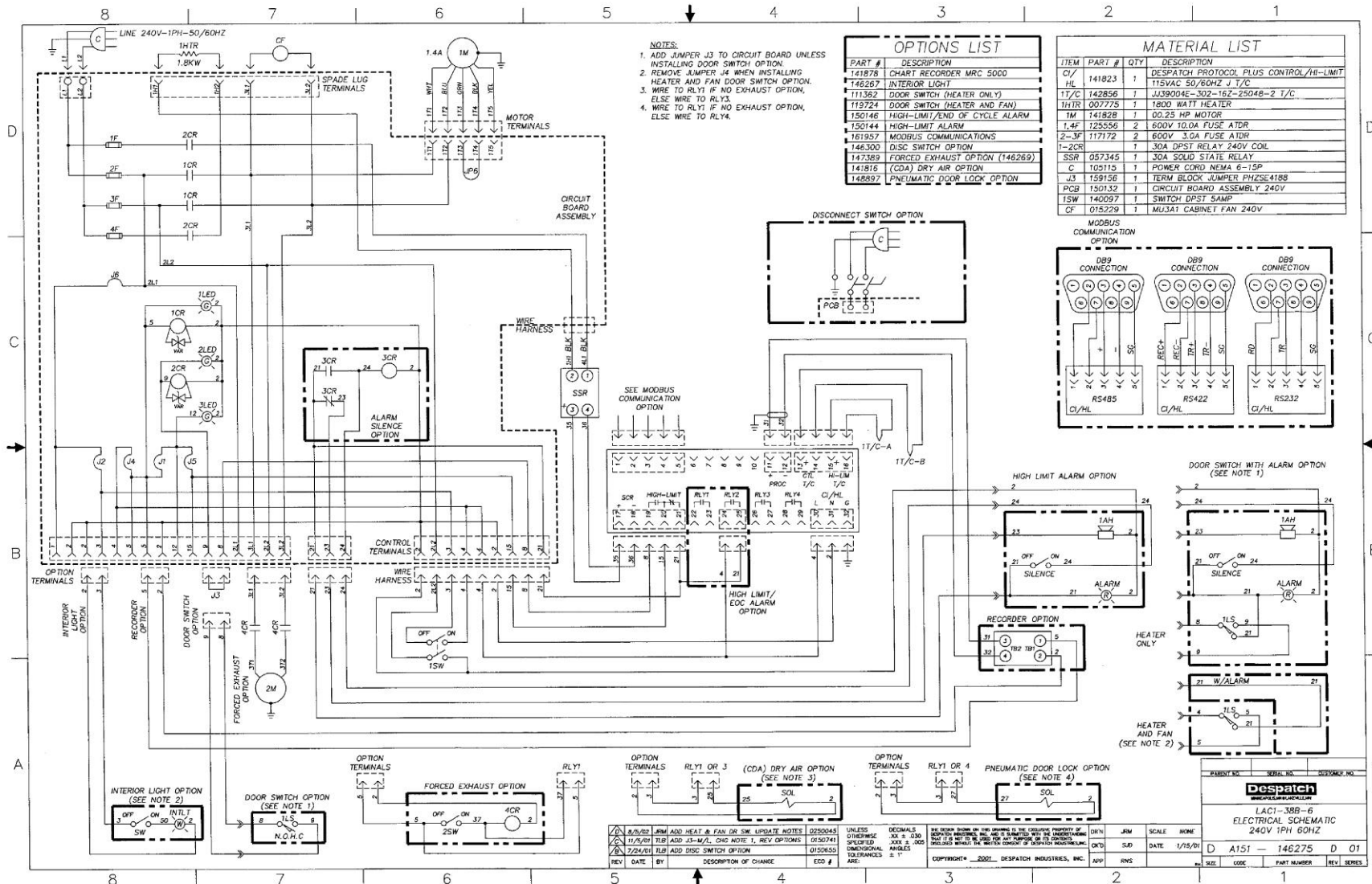

Figure 15. LAC1-38B-6 (Excerpt from drawing 146275D01).

Copyright © 2011 by Despatch Industries.

All rights reserved. No part of the contents of this manual may be reproduced, copied or transmitted in any form or by any means including graphic, electronic, or mechanical methods or photocopying, recording, or information storage and retrieval systems without the written permission of Despatch Industries, unless for purchaser's personal use.

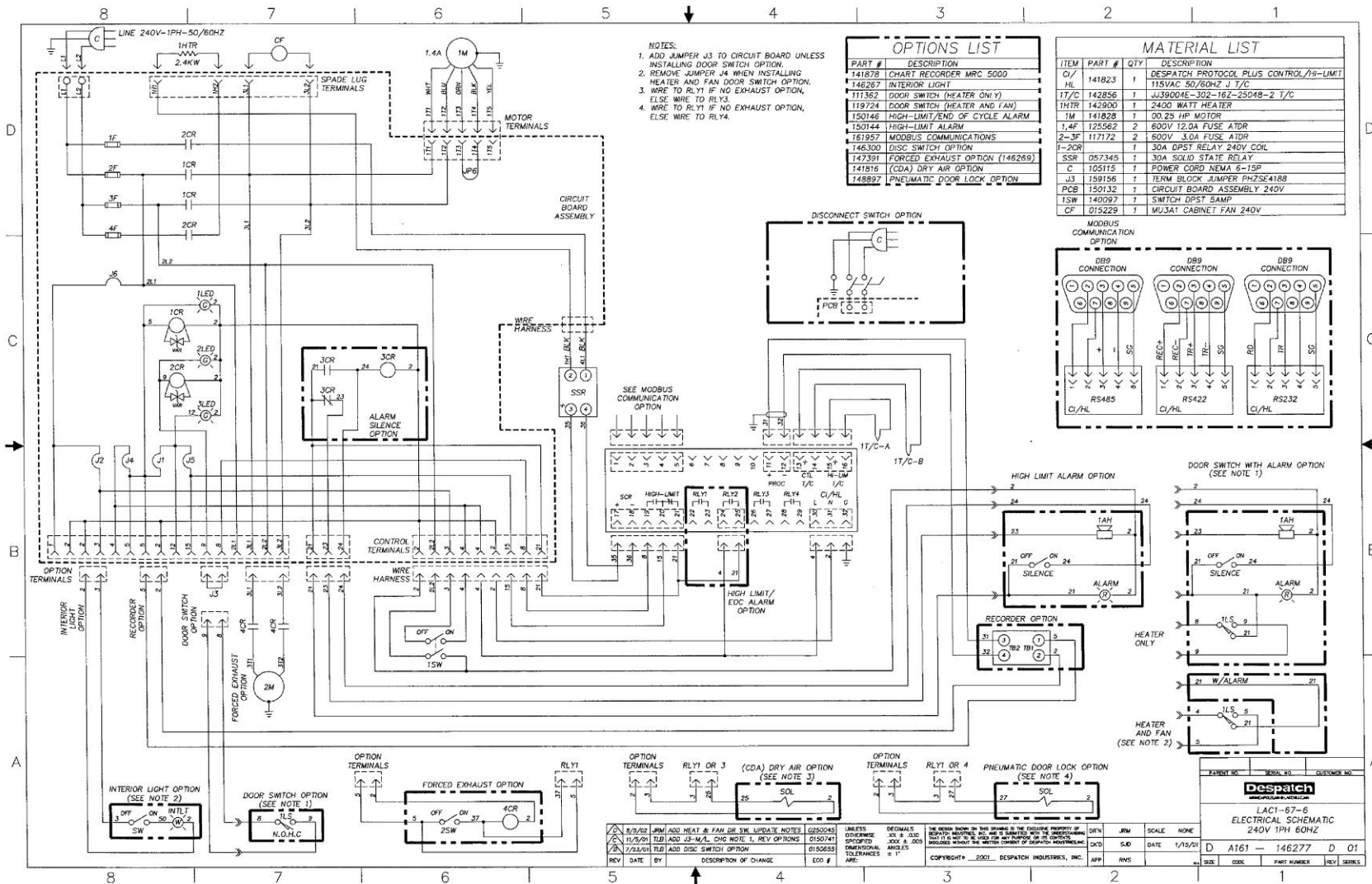

Figure 16. LAC1-67-6 (Excerpt from drawing 146277D01).

Copyright © 2011 by Despatch Industries.

All rights reserved. No part of the contents of this manual may be reproduced, copied or transmitted in any form or by any means including graphic, electronic, or mechanical methods or photocopying, recording, or information storage and retrieval systems without the written permission of Despatch Industries, unless for purchaser's personal use.

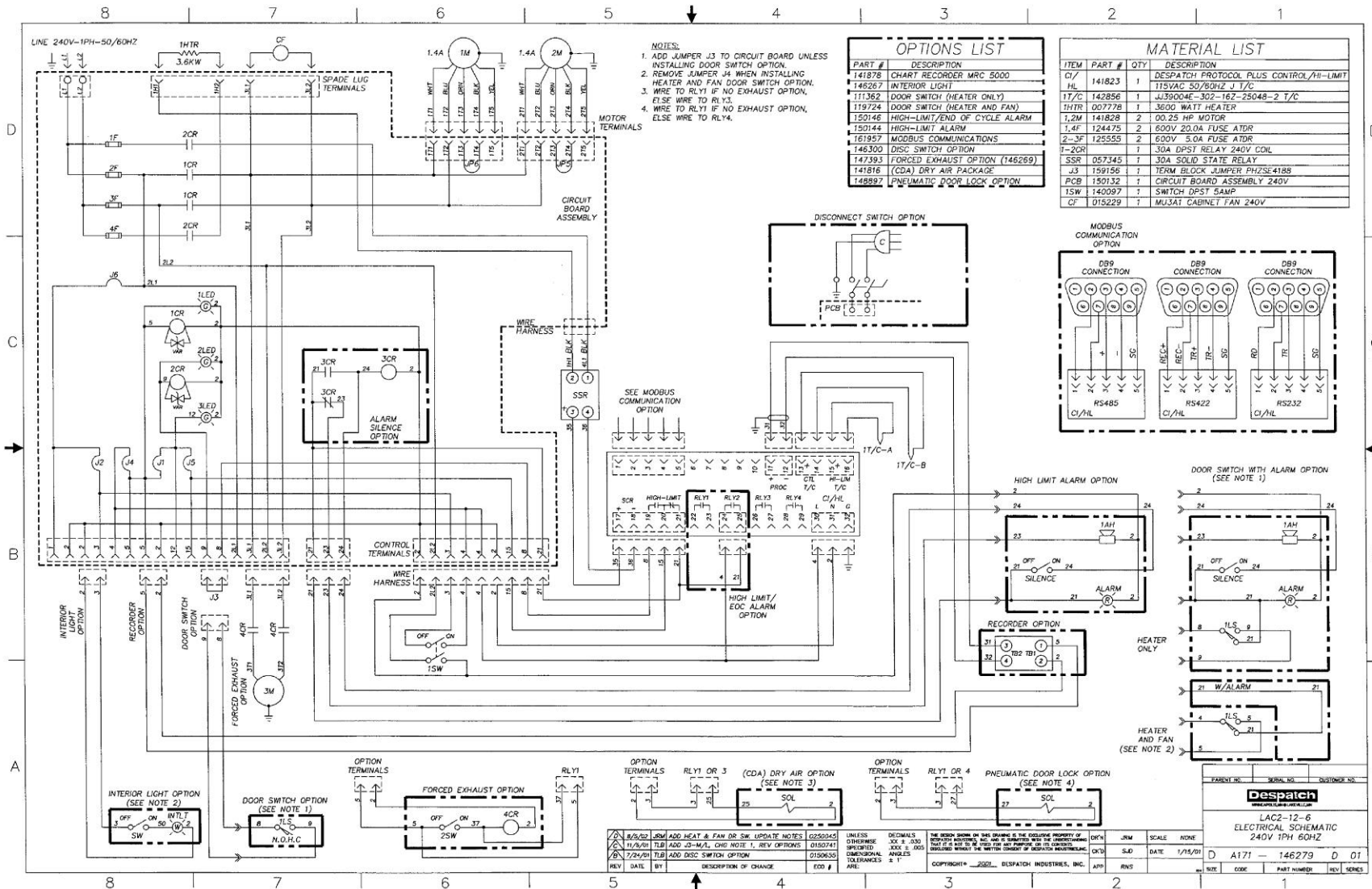

Figure 17. LAC2-12-6 (Excerpt from drawing 146279D01).

Copyright © 2011 by Despatch Industries.

All rights reserved. No part of the contents of this manual may be reproduced, copied or transmitted in any form or by any means including graphic, electronic, or mechanical methods or photocopying, recording, or information storage and retrieval systems without the written permission of Despatch Industries, unless for purchaser's personal use.

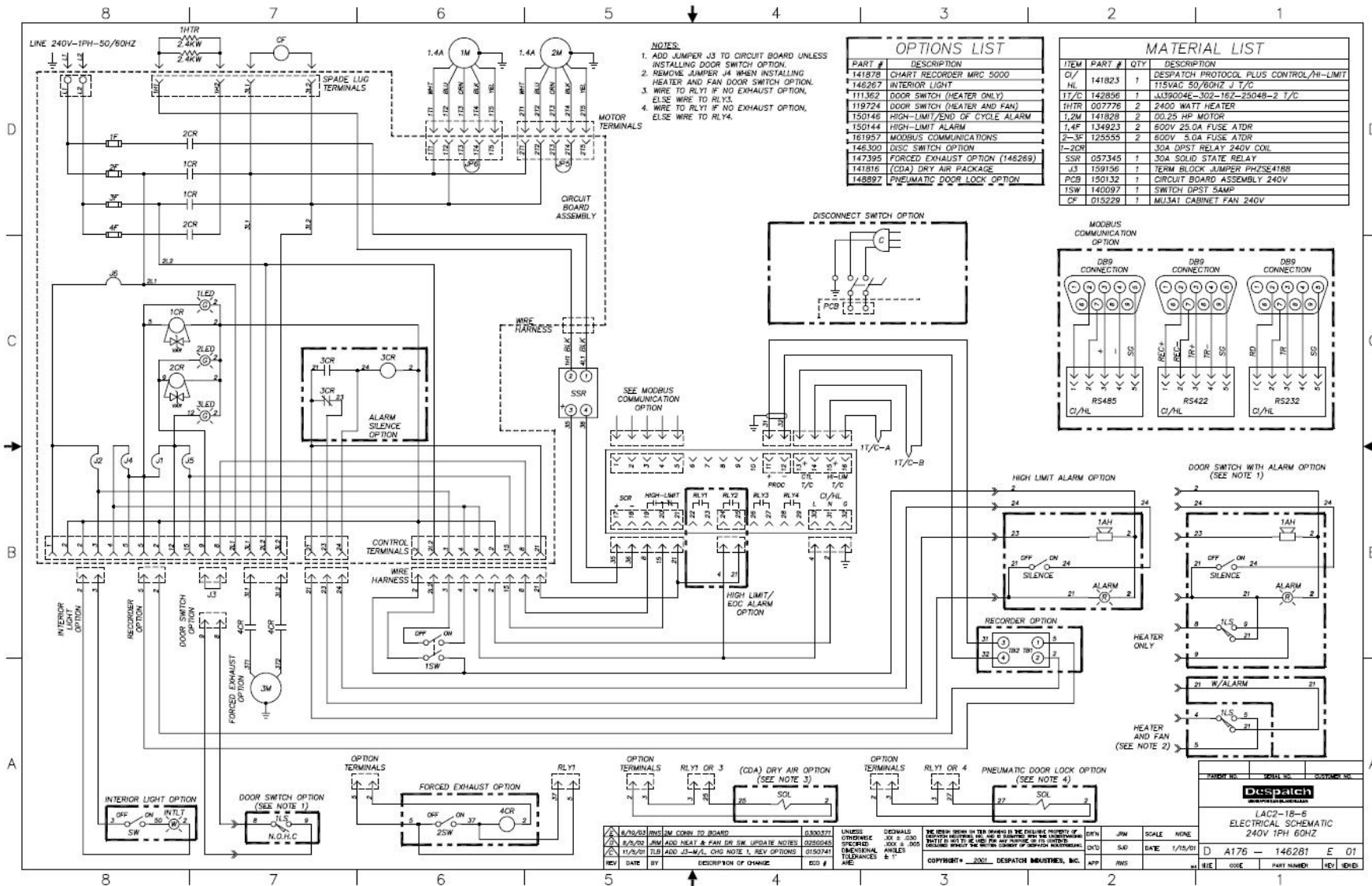

Figure 18. LAC2-18-6 (Excerpt from drawing 146281E01).

Copyright © 2011 by Despatch Industries.

All rights reserved. No part of the contents of this manual may be reproduced, copied or transmitted in any form or by any means including graphic, electronic, or mechanical methods or photocopying, recording, or information storage and retrieval systems without the written permission of Despatch Industries, unless for purchaser's personal use.

Despatch

INDUSTRIES

GLOBAL HEADQUARTERS

Despatch Industries
8860 207th Street West
Minneapolis, MN 55044
USA

US toll free: 1-888-337-7282
international/main: 1-952-469-5424
fax: 1-952-469-4513

info@despatch.com
www.despatch.com

SERVICE AND TECHNICAL SUPPORT

service parts: 1-800-473-7373
international service/main: 1-952-469-8230
service fax: 1-952-469-8193

service@despatch.com

© 2010 Despatch Industries. All rights reserved.
Despatch is a registered trademark of Despatch Industries in the U.S. and other countries.
Ransco is a product line of Despatch Industries.

Copyright © 2011 by Despatch Industries.

All rights reserved. No part of the contents of this manual may be reproduced, copied or transmitted in any form or by any means including graphic, electronic, or mechanical methods or photocopying, recording, or information storage and retrieval systems without the written permission of Despatch Industries, unless for purchaser's personal use.