

THRIVING ON INNOVATION

Despatch
INDUSTRIES

P1400+ TEMPERATURE CONTROLLER INSTRUCTION MANUAL

E-104

PN 197252

REVISION 1-09

SERVICE AND TECHNICAL SUPPORT

service parts: 1-800-473-7373

international service/main: 1-952-469-8230

service fax: 1-952-469-8193

service@despatch.com

GLOBAL HEADQUARTERS

phone: 1-888-DESPATCH (1-888-337-7282)

international/main: 1-952-469-5424

fax: 1-952-469-4513

sales@despatch.com

www.despatch.com

8860 207th Street West

Minneapolis, MN 55044 USA

Despatch
INDUSTRIES

MINNEAPOLIS • SHANGHAI • BERLIN • SINGAPORE • TAIPEI

TABLE OF CONTENTS

TABLE OF CONTENTS	iii
SECTION 1: INTRODUCTION	1
1.1 <i>General</i>	1
SECTION 2: INSTALLATION.....	2
2.1 <i>Unpacking</i>	2
2.2 <i>Installation</i>	2
2.3 <i>Panel Cut-outs</i>	3
2.4 <i>Panel-Mounting</i>	3
SECTION 3: PLUG-IN OPTIONS	5
3.1 <i>Options Modules and Functions</i>	5
3.2 <i>Auto Detection of Option Modules</i>	5
3.3 <i>Preparing to Install or Remove Options Modules</i>	7
3.4 <i>Removing/Replacing Option Modules</i>	7
3.5 <i>Replacing the Instrument in its Housing</i>	9
SECTION 4: WIRING INSTRUCTIONS	10
4.1 <i>Installation Considerations</i>	10
4.2 <i>AC Power Wiring - Neutral (for 100 to 240V AC versions)</i>	10
4.3 <i>Wire Isolation</i>	10
4.4 <i>Use of Shielded Cable</i>	11
4.5 <i>Noise Suppression at Source</i>	11
4.6 <i>Sensor Placement (Thermocouple or RTD)</i>	12
4.7 <i>Thermocouple Wire Identification Chart</i>	13
4.8 <i>Connections and Wiring</i>	13
4.9 <i>Power Connections - Mains Powered Instruments</i>	15
4.10 <i>Power Connections - 24/48V AC/DC Powered Instruments</i>	15
4.11 <i>Universal Input Connections - Thermocouple (T/C)</i>	16
4.12 <i>Universal Input Connections – PT100 (RTD) input</i>	16
4.13 <i>Universal Input Connections - Linear Volt, mV or mA input</i>	17
4.14 <i>Option Slot 1</i>	17
Relay Output Module.....	17
Option Slot 1 - SSR Driver Output Module.....	18
Option Slot 1 - Triac Output Module.....	18
Option Slot 1 - Linear Voltage or mADC Output module.....	18
4.15 <i>Option Slot 2</i>	19
Option Slot 2 - Relay Output Module.....	19
Option Slot 2 - SSR Driver Output Module.....	19
Option Slot 2 - Triac Output Module.....	19
Option Slot 2 - Linear Voltage or mADC Output module.....	20
4.16 <i>Option Slot 3</i>	20
Option Slot 3 - Relay Output Module.....	20
Option Slot 3 - SSR Driver Output Module.....	21
Option Slot 3 - Linear Voltage or mADC Output module.....	21
Option Slot 3 - Transmitter Power Supply Module	21
4.17 <i>Option Slot A</i>	22
Option Slot A Connections - RS485 Serial Communications Module.....	22
Option Slot A Connections - Digital Input Module	22
Option Slot A Connections – Basic Auxiliary Input Module.....	22
4.18 <i>Option Slot B</i>	23
Option Slot B Connections – Heater Current Input Module	23
Option Slot B Connections – Digital Input 2 (Full Auxiliary Module)	23
Option Slot B Connections – ¹ / ₄ DIN Full Auxiliary Input Module.....	23

SECTION 5: POWERING UP	24
5.1 Powering Up Procedure.....	24
5.2 Overview of Front Panel	24
5.3 Displays	25
5.4 Keypad.....	25
5.5 LED Functions	25
SECTION 6: MESSAGES AND ERROR INDICATIONS	26
SECTION 7: INSTRUMENT OPERATION MODES.....	27
7.1 Select Mode	27
Entry into the Select Mode.....	27
Navigating in Select Mode	27
Unlock Codes.....	27
7.2 Automatic Tune Mode.....	28
Navigating in Automatic Tune Mode.....	28
7.3 Product Information Mode	29
Navigating in the Product Information Mode	29
7.4 Lock Code View.....	31
Entry and Navigating in Lock Code View Mode	31
SECTION 8: 1400+ CONTROLLER – MODEL GROUP.....	32
8.1 1400+ Controllers - Configuration Mode.....	32
Entry into the Configuration Mode	32
Scrolling through Parameters and Values	32
Changing Parameter Values.....	33
8.2 1400+ – Setup Mode	39
Entry into the Setup Mode	39
Scrolling through Parameters & Values.....	39
Changing Parameter Values.....	39
8.3 1400+ Controllers - Operator Mode.....	43
1400+ Controllers – Extended Operator Mode.....	43
Navigating in Operator Mode.....	43
Adjusting the Local Setpoint(s)	45
8.4 Adjusting the Setpoint Ramp Rate.....	45
8.5 Manual Control Mode.....	46
Selecting/deselecting Manual Control Mode	46
8.6 1400+ Controllers –Communications Parameters.....	46
Bit Parameters	46
Word Parameters.....	47
SECTION 9: MANUALLY TUNING CONTROLLERS.....	53
9.1 Single Control Tuning (PID with Primary Output only)	53
9.2 Dual Control Tuning (PID with Primary and Secondary Outputs)	54
9.3 Valve Control Tuning (PI with Linear Outputs)	54
9.4 Manually Fine Tuning.....	56
SECTION 10: MODBUS SERIAL COMMUNICATIONS	57
10.1 Physical Layer.....	57
10.2 Link Layer	58
10.3 Device Addressing.....	59
10.4 Supported Modbus Functions.....	59
10.5 Function Descriptions	59
Read Coil/Input Status (Function 01 / 02)	60
Read Holding/Input Registers (Function 03 / 04)	60
Force Single Coil (Function 05)	61
Pre-Set Single Register (Function 06).....	61
Loopback Diagnostic Test (Function 08)	61
Pre-Set Multiple Registers (Function 10 Hex)	62
Exception Responses	62

SECTION 11: ASCII COMMUNICATIONS	64
11.1 <i>Physical Layer</i>	64
11.2 <i>Device Addressing</i>	64
11.3 <i>Session Layer</i>	64
Type 1 Message	65
Type 2 Message	66
Type 3 Message	66
Type 4 Message	67
11.4 <i>Error Response</i>	67
SECTION 12: CALIBRATION MODE.....	68
12.1 <i>Equipment Required For Checking or Calibrating the Universal Input</i>	68
12.2 <i>Calibration Check</i>	68
12.3 <i>Recalibration Procedure</i>	69
SECTION 13: APPENDIX 1 – GLOSSARY	70
SECTION 14: APPENDIX 2 – SPECIFICATION	93
14.1 <i>Universal Input</i>	93
General Input Specifications	93
Thermocouple.....	93
Thermocouple Ranges Available.....	93
Thermocouple Performance	94
Resistance Temperature Detector (RTD).....	94
RTD Ranges Available	94
RTD Performance.....	95
DC Linear	95
DC Linear Ranges Available.....	95
DC Linear Performance	95
14.2 <i>Auxiliary Inputs</i>	96
14.3 <i>Digital Inputs</i>	96
14.4 <i>Output Specifications</i>	96
Output Module Types	96
Specifications of Output Types.....	97
14.5 <i>Control Specifications</i>	99
14.6 <i>Process Alarms</i>	99
14.7 <i>Digital Communications</i>	99
14.8 <i>Reference Conditions</i>	100
14.9 <i>Operating Conditions</i>	100
14.10 <i>Standards</i>	100
14.11 <i>Physical Specifications</i>	100
SECTION 15: APPENDIX 3 – PRODUCT CODING	101

How to use this manual

This manual is structured to give easy access to the information required for all aspects of the installation and use and of the products:

Section 1: **Introduction** - A brief description of the product range.

Section 2: **Installation** - Unpacking, installing and panel mounting instructions.

Section 3: **Plug-in Options** - Installation of the plug-in option modules.

Section 4: **Wiring Guidelines** - Guidance on good wiring practice, noise avoidance, wiring diagrams and input/output connections.

Section 5: **Powering Up** - Powering up procedure and descriptions of displays & switches.

Section 6: **Messages & Error Indications** - Display Messages and fault indications.

Section 7: **Operation Modes** - Describes operating modes common across the range. These include Select Mode for gaining access to the Setup and Configuration menus, Automatic tuning on controllers and the Product information menus.

Section 8: **1400+ Model Group** - Describes unique operating features of these process controllers. It covers the Configuration, Setup & Operator menus, Communications parameters, adjusting Setpoint, use of Manual Control and PID auto-tuning.

Section 9: **Manually Tuning Controllers** - Advice on manually adjusting the Process and Valve Controllers tuning parameters.

Section 10: **Modbus Serial Communications** - Details the physical layer and message formats used for the Modbus communications protocol common to all products in the range.

Section 11: **ASCII Serial Communications** - Details the physical layer and message formats used for the ASCII serial communications protocol available on some products.

Section 12: **Calibration Mode** - Step-by-step instructions to calibrate the instrument. This section is intended for use by suitably qualified personnel.

Appendix 1: **Glossary** - Explanations of the terms used and product features.

Appendix 2: **Specification** - Technical specifications for all products in the range.

Appendix 3: **Product Coding** - Product model/ordering codes.

SECTION 1: INTRODUCTION

1.1 *General*

These instruments are microprocessor based process controllers. They can measure, display or control process variables such as temperature, pressure, flow and level from a variety of inputs.

The operating voltage is either 100-240V at 50/60 Hz or 24V-48V AC/DC depending on the model purchased. EEPROM technology protects against data or configuration loss during power outages.

Inputs are user configurable for connection to thermocouple and RTD probes, as well as linear process signal types such as mVDC, VDC or mADC. Output options include relays, SSR drivers, triacs or linear mV/voltage modules. These can be used for process control, valve control, alarms or retransmission of the process variable or setpoint to external devices such as data recorders or PLC's. A Transmitter Power Supply option module can provide an unregulated 24V DC (22mA) auxiliary output voltage for external signal transmitters.

Alarm indication is standard on all instruments. Alarms may be set as process high or low, deviation (active above or below controller setpoint), band (active both above and below setpoint), or control loop types. These alarms can be linked to any suitable output. Alarm status is indicated by LED's or the alarm status screen.

Controllers can be programmed for on-off, time proportioning, or current proportioning control implementations, depending on the output modules fitted, and feature manual or automatic tuning of the PID parameters. A secondary control output is available when additional output modules are fitted. Optional analogue controller Remote Setpoint inputs are included in the range. Control functions, alarm settings and other parameters are easily adjusted from the front keypad or via PC based configuration software.

SECTION 2: INSTALLATION

2.1 Unpacking

1. Remove the product from its packing. Retain the packing for future use, in case it is necessary to transport the instrument to a different site or to return it to the supplier for repair/testing.
2. The instrument is supplied with a panel gasket and push fit fixing strap. A single sheet concise manual is also supplied in one or more languages. Examine the delivered items for damage or defects. If any are found, contact your supplier immediately.

2.2 Installation

CAUTION:

Installation and configuration should be performed only by personnel who are technically competent and authorised to do so. Local regulations regarding electrical installation and safety must be observed.

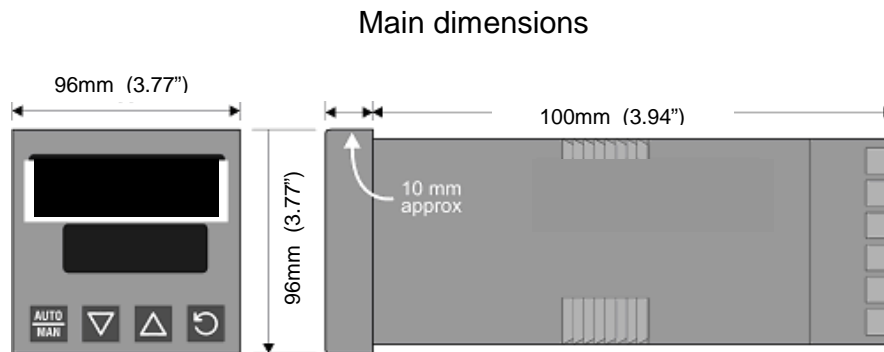

2.3 Panel Cut-outs

The mounting panel must be rigid and may be up to 6.0mm (0.25 inches) thick. The cut-outs required for the instruments are shown below.

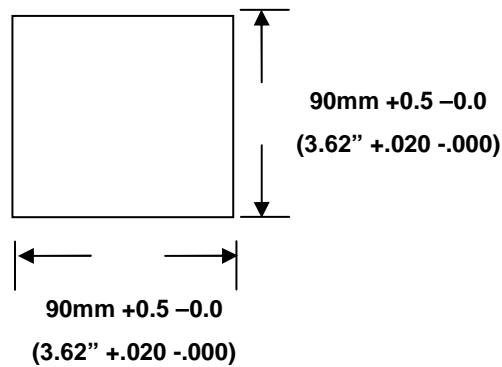

Figure 2. Panel cut-out size

2.4 Panel-Mounting

CAUTION:

Ensure the inside of the panel is with the instruments operating temperature and that there is adequate air flow to prevent overheating.

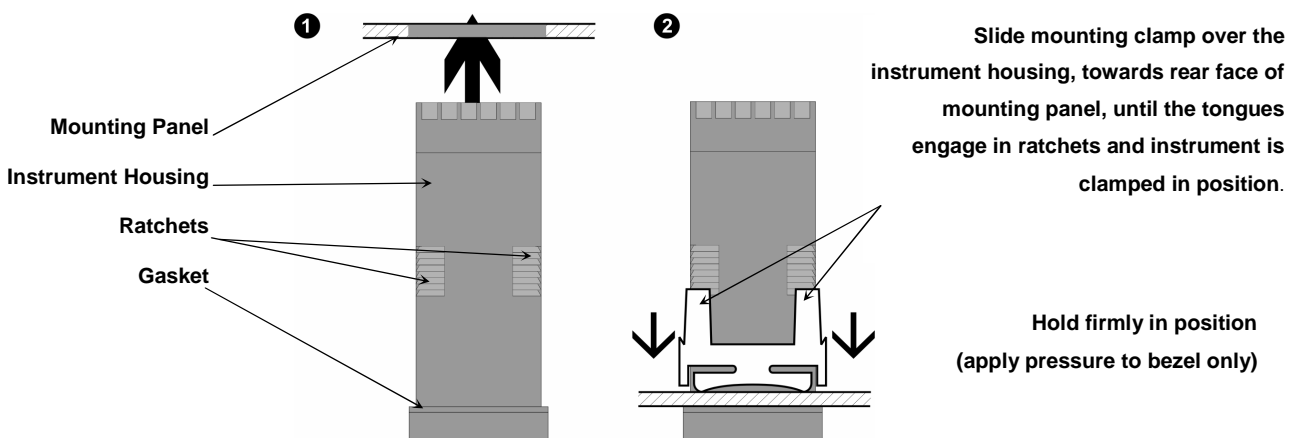

Figure 3. Panel-Mounting the instrument

CAUTION:

Do not remove the panel gasket, as this may result in inadequate clamping and sealing of the instrument to the panel.

Once the instrument is installed in its mounting panel, it may be subsequently removed from its housing, if necessary, as described in the Fitting and Removing Option Modules section.

Instruments may be mounted side-by-side in a multiple installation, but instrument to panel moisture and dust sealing will be compromised. The cut-out width (for n instruments) is shown below.

$\frac{1}{4}$ - DIN Instruments:

$(96n - 4)$ mm or $(3.78n - 0.16)$ inches

If panel sealing must be maintained, mount each instrument into an individual cut-out with 6mm or more clearance between the edges of the holes.

Note:

The mounting clamp tongues may engage the ratchets either on the sides or the top/bottom faces of the Instrument housing. When installing several Instruments side-by-side in one cut-out, use the ratchets on the top/bottom faces.

SECTION 3: PLUG-IN OPTIONS

3.1 Options Modules and Functions

A range of plug-in option modules is available to add additional input, output and communication functions to the instruments in the range. These modules can be either pre-installed at the time of manufacture, or retrofitted in the field.

The modules are installed between the instruments main circuit boards into the four option slots. These are designated as Slots 1, 2, 3, A & B. Installation is detailed below.

Note:

Slot 1 modules cannot be fitted into Slot 2 or 3. Slot 2 & 3 modules cannot be fitted into Slot 1. Some Slot 2 & 3 modules should only be fitted into one of the two slots. This is detailed in the - Option Module vs. Model Matrix below.

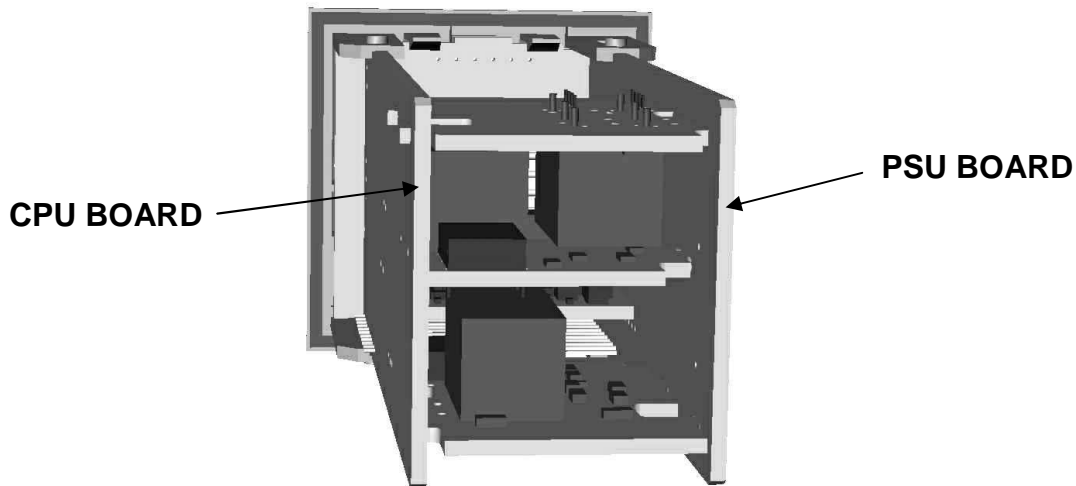

Figure 4. Typical rear view (uncased) & main board positions

3.2 Auto Detection of Option Modules

The instrument automatically detects which option modules have been fitted into each slot. In Configuration Mode, the menus will change to reflect the options compatible with the hardware fitted. The modules fitted can be viewed in the products information menu, as detailed in the Product Information Mode section of this manual.

Table 1. Option Module Available

MODULE PART NUMBER & Function	1400+
OPTION SLOT 1	
PO1-C10 Relay	
PO1-C50 SSR Driver	
PO1-C80 Triac	
PO1-C21 Linear mA/V DC	
OPTION SLOT 2	
PO2-C10 Relay	
PO2-C50 SSR Driver	
PO2-C80 Triac	
PO2-C21 Linear mA/V DC	
PO2-W09 Dual Relay	
OPTION SLOT 3	
PO2-C10 Relay	
PO2-C50 SSR Driver	
PO2-C21 Linear mA/V DC	
PO2-W08 TransmitterPSU	
PO2-W09 Dual Relay	
OPTION SLOT A	
PA1-W06 RS485 Comms	
PA1-W03 Digital Input	
PA1-W04 Basic Aux Input	
OPTION SLOT B	
PB1-W0R Full Aux Input	
SOFTWARE & ACCESSORIES	
PS1-CON Config Software	

KEY	Option Possible		Option Not Possible	
------------	-----------------	--	---------------------	--

3.3 Preparing to Install or Remove Options Modules

CAUTION:

Before removing the instrument from its housing, ensure that all power has been removed from the rear terminals.

1. Remove the instrument from its housing by gripping the side edges of the front panel (there is a finger grip on each edge) and pull the instrument forwards. This will release the instrument from the rear connectors in the housing and will give access to the PCBs.
2. Take note of the orientation of the instrument for subsequent replacement into the housing. The positions of the main and option PCBs in the instrument are shown below.

3.4 Removing/Replacing Option Modules

With the instrument removed from its housing:

1. To remove or replace modules into Option Slots 1,A or B, it is necessary to gently separate the CPU and PSU PCBs. This is achieved by detaching the main boards (PSU and CPU) from the front moulding by lifting first the upper and then lower mounting struts as shown. This frees the boards from the front. If only Option slots 2 or 3 are to be changed, this stage is not required as these slots are accessible without separating the main boards from the front.

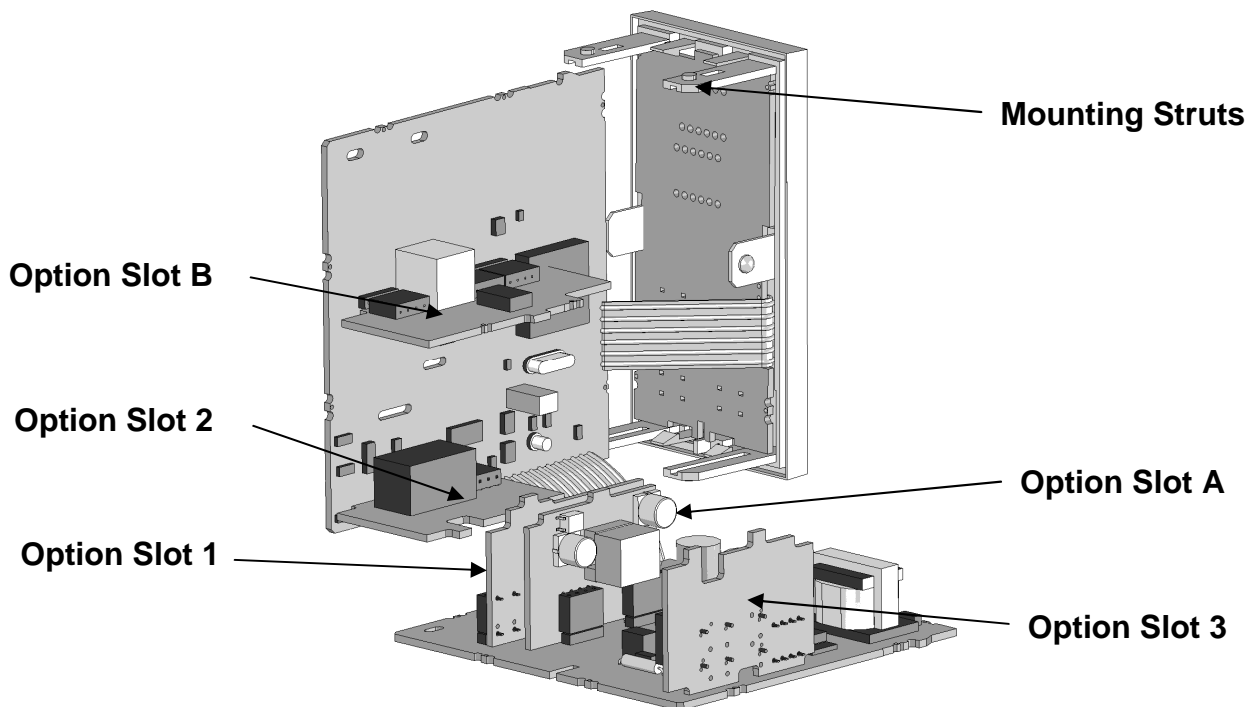

Figure 5. Location of Option Modules - $\frac{1}{4}$ DIN Instruments

CAUTION:

Take care not to put undue stress on the ribbon cable attaching the display and CPU boards.

2. Remove or fit the modules into the Option slots as required. The location of the connectors is shown below. Tongues on each option module locate into a slots cut into the main boards, opposite each of the connectors.

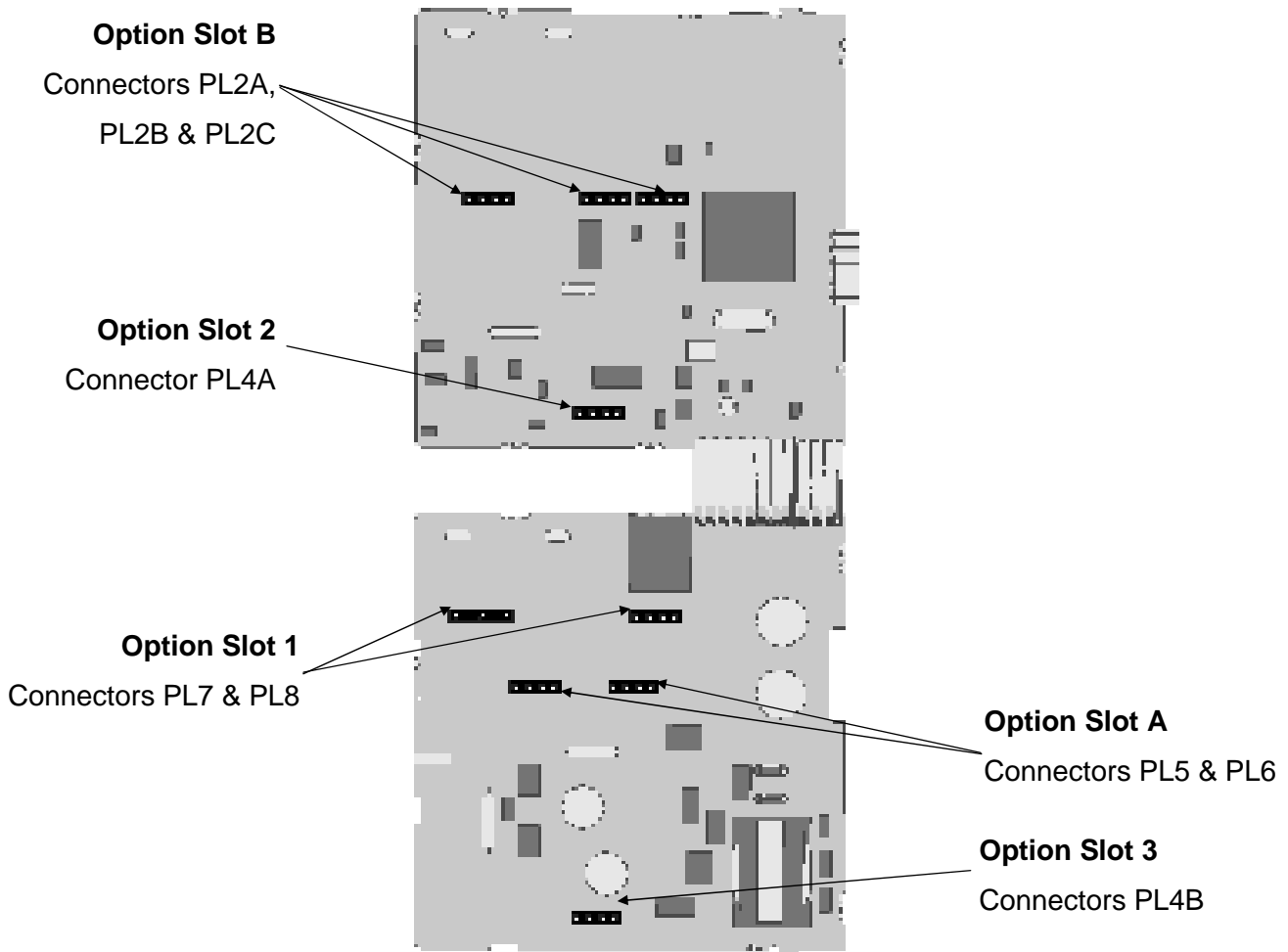

Figure 6. Option Module Connectors - $\frac{1}{4}$ DIN Instruments

CAUTION:

Check for correct orientation of the modules and that all pins locate correctly into the socket

3.5 Replacing the Instrument in its Housing

With the required option modules correctly located into their respective positions the instrument can be replaced into its housing as follows:

1. If required, move the CPU and PSU boards back together, taking care to locate the option module tongues into the slots in the board opposite. Hold the main boards together while relocating them back into the mounting struts on the front panel.
2. Align the CPU and PSU PCBs with their guides and connectors in the housing.
3. Slowly and firmly, push the instrument in position.

CAUTION:

Ensure that the instrument is correctly orientated. A mechanical stop will operate if an attempt is made to insert the instrument in the wrong orientation, this stop MUST NOT be over-ridden.

SECTION 4: WIRING INSTRUCTIONS

Electrical noise is a phenomenon typical of industrial environments. As with any instrumentation, these guidelines should be followed to minimize the effect of noise.

4.1 Installation Considerations

Ignition transformers, arc welders, mechanical contact relays and solenoids are all common sources of electrical noise in an industrial environment and therefore the following guidelines **MUST** be followed.

1. If the instrument is being installed in existing equipment, the wiring in the area should be checked to ensure that good wiring practices have been followed.
2. Noise-generating devices such as those listed should be mounted in a separate enclosure. If this is not possible, separate them from the instrument, by the largest distance possible.
3. If possible, eliminate mechanical contact relays and replace with solid-state relays. If a mechanical relay being powered by an output of this instrument cannot be replaced, a solid-state relay can be used to isolate the instrument.
4. A separate isolation transformer to feed only the instrumentation should be considered. The transformer can isolate the instrument from noise found on the AC power input.

4.2 AC Power Wiring - Neutral (for 100 to 240V AC versions)

It is good practice to ensure that the AC neutral is at or near ground (earth) potential. A proper neutral will help ensure maximum performance from the instrument.

4.3 Wire Isolation

Four voltage levels of input and output wiring may be used with the unit:

1. Analogue input or output (for example thermocouple, RTD, VDC, mVDC or mADC)
2. Relays & Triac outputs
3. SSR Driver outputs
4. AC power

CAUTION:

The only wires that should run together are those of the same category.

If any wires need to run parallel with any other lines, maintain a minimum space of 150mm between them.

If wires MUST cross each other, ensure they do so at 90 degrees to minimise interference.

4.4 Use of Shielded Cable

All analogue signals must use shielded cable. This will help eliminate electrical noise induction on the wires. Connection lead length must be kept as short as possible keeping the wires protected by the shielding. The shield should be grounded at one end only. The preferred grounding location is at the sensor, transmitter or transducer.

4.5 Noise Suppression at Source

Usually when good wiring practices are followed, no further noise protection is necessary. Sometimes in severe electrical environments, the amount of noise is so great that it has to be suppressed at source. Many manufacturers of relays, contactors etc supply 'surge suppressors' which mount on the noise source. For those devices that do not have surge suppressors supplied, Resistance-Capacitance (RC) networks and/or Metal Oxide Varistors (MOV) may be added.

Inductive coils:- MOVs are recommended for transient suppression in inductive coils, connected in parallel and as close as possible to the coil. Additional protection may be provided by adding an RC network across the MOV.

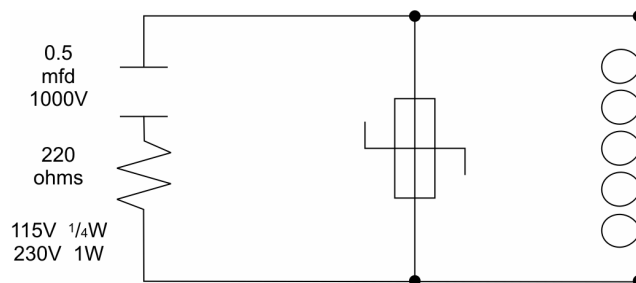

Figure 7. Transient suppression with inductive coils

Contacts:- Arcing may occur across contacts when they open and close. This results in electrical noise as well as damage to the contacts. Connecting a properly sized RC network can eliminate this arc.

For circuits up to 3 amps, a combination of a 47 ohm resistor and 0.1 microfarad capacitor (1000 volts) is recommended. For circuits from 3 to 5 amps, connect two of these in parallel.

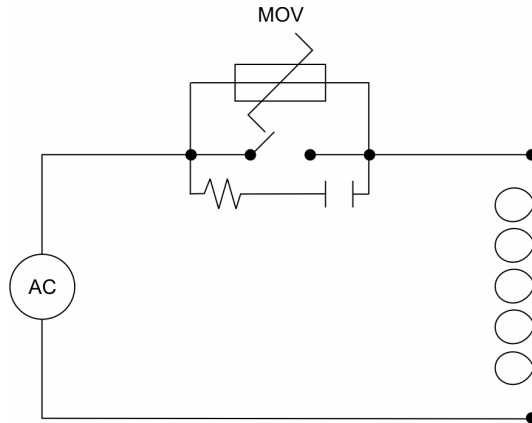

Figure 8. Contact noise suppression

4.6 Sensor Placement (Thermocouple or RTD)

If the temperature probe is to be subjected to corrosive or abrasive conditions, it must be protected by an appropriate thermowell. The probe must be positioned to reflect true process temperature:

1. In a liquid media - the most agitated area
2. In air - the best circulated area

CAUTION:

The placement of probes into pipe work some distance from the heating vessel leads to transport delay, which results in poor control.

For a two wire RTD a wire link should be used in place of the third wire. Two wire RTDs must only be used with lead lengths less than 3 metres. Use of three wire RTDs is strongly recommended.

4.7 Thermocouple Wire Identification Chart

The different thermocouple types are identified by their wires colour, and where possible, the outer insulation as well. There are several standards in use throughout the world.

The table below shows the wire and sheath colours used for most thermocouple types. The format used in this table is:

+ Wire	Sheath	common
- Wire		

Table 2. Thermocouple Extension Wire Colours

Type		International IEC584-3	USA ANSI MC 96.1	British BS1843	French NFC 42-324	German DIN 43710
J	+*	Black	White	Yellow	Yellow	Red
	-	Black	Black	Black	Black	Blue
T	+	Brown	Blue	White	Yellow	Red
	-	Brown	Blue	Blue	Blue	Brown
K	+	Green	Yellow	Brown	Yellow	Red
	-*	Green	Yellow	Red	Yellow	Green
N	+	Pink	Orange	Orange		
	-	Pink	Orange	Orange		
B	+	Grey	Grey			Red
	-	Grey	Grey			Grey
R & S	+	Orange	Black	White	Yellow	Red
	-	Orange	Green	Green	Green	White
C (W5)	+		White			
	-		White			

Note:

* = Wire is magnetic

4.8 Connections and Wiring

The rear terminal connections for 1/4 DIN instruments are illustrated in the following diagram.

In general, all wiring connections are made to the instrument after it is installed. Copper wires must be used for all connections (except thermocouple signal wires).

WARNING:

TO AVOID ELECTRICAL SHOCK, AC POWER WIRING MUST NOT BE CONNECTED TO THE SOURCE DISTRIBUTION PANEL UNTIL ALL WIRING PROCEDURES ARE COMPLETED.

WARNING:

CHECK THE INFORMATION LABEL ON THE CASE TO DETERMINE THE CORRECT VOLTAGE BEFORE CONNECTING TO A LIVE SUPPLY.

Note:

The wiring diagram below shows all possible combinations. The actual connections required depend upon the features available on the model and the modules and options fitted.

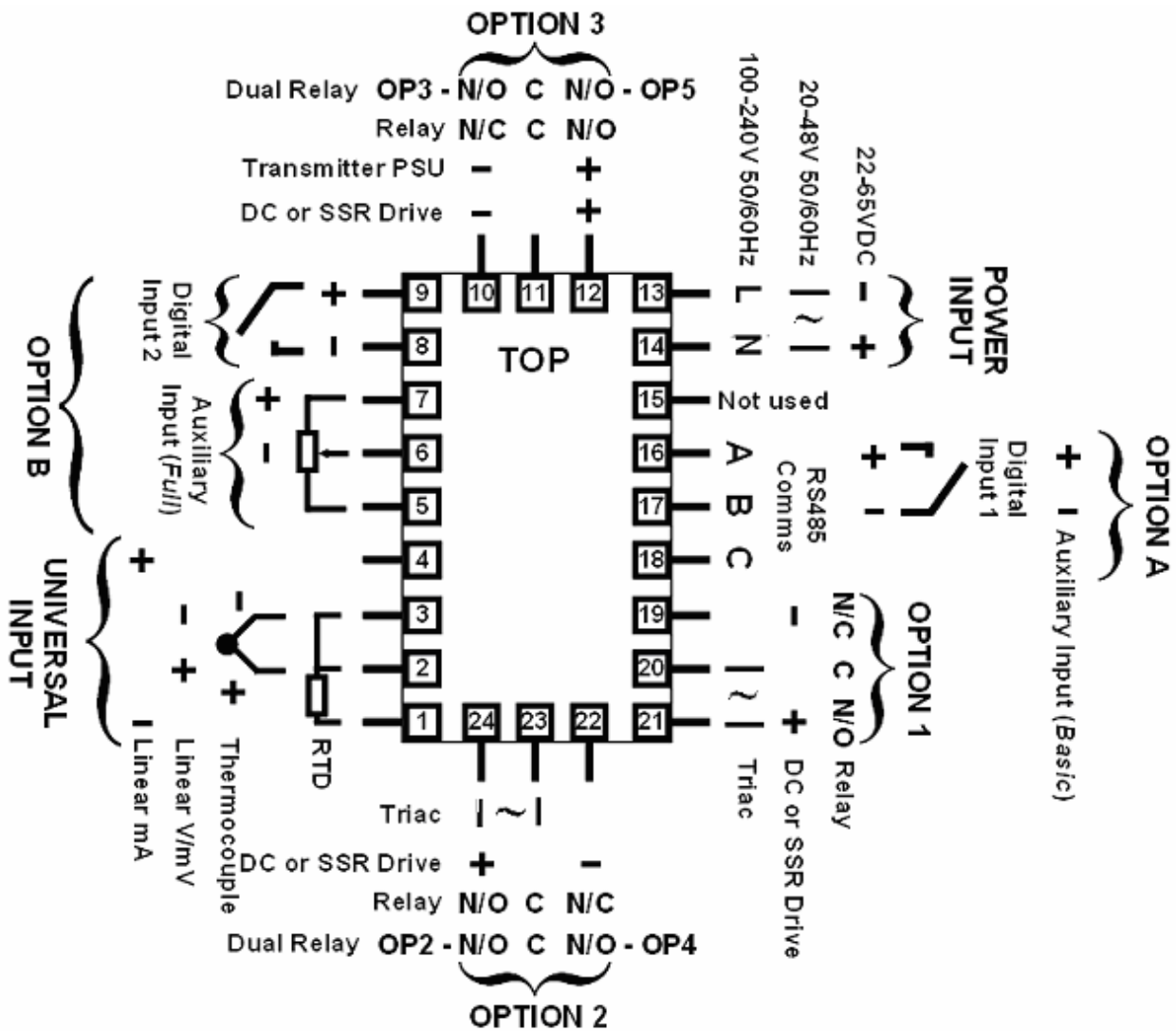

Figure 9. Rear terminals (¹/₄-DIN Instruments)

4.9 Power Connections - Mains Powered Instruments

Mains powered instruments operate from a 100 to 240V ($\pm 10\%$) 50/60Hz supply. Power consumption is 7.5VA. Connect the line voltage (live and neutral) as illustrated via a two-pole isolating switch (preferably located near the equipment) and a 1amp anti-surge fuse. If the instrument has relay outputs with contacts carrying mains voltage, it is recommended that the relay contacts supply should be switched and fused in a similar manner, but should be separate from the instruments mains supply.

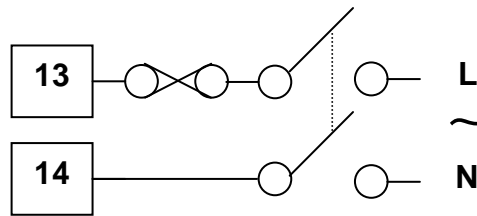

Figure 10. Mains Power Connections

WARNING:

CHECK THE INFORMATION LABEL ON THE CASE TO DETERMINE THE CORRECT VOLTAGE BEFORE CONNECTING TO A LIVE SUPPLY.

CAUTION:

This equipment is designed for installation in an enclosure that provides adequate protection against electric shock

4.10 Power Connections - 24/48V AC/DC Powered Instruments

24/48V AD/DC powered instruments will operate from a 20 to 48V AC or 22 to 55V DC supply. AC power consumption is 7.5VA max, DC power consumption is 5 watts max. Connection should be via a two-pole isolating switch (preferably located near the equipment) and a 315mA slow-blow (anti-surge type T) fuse.

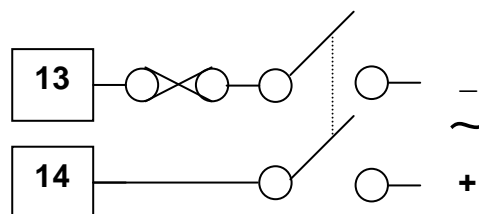

Figure 11. 24/48V AC/DC Power Connections

WARNING:

CHECK THE INFORMATION LABEL ON THE CASE TO DETERMINE THE CORRECT VOLTAGE BEFORE CONNECTING TO A LIVE SUPPLY.

4.11 Universal Input Connections - Thermocouple (T/C)

Use only the correct thermocouple wire or compensating cable from the probe to the instrument terminals avoiding joints in the cable if possible. Failure to use the correct wire type will lead to inaccurate readings. Ensure correct polarity of the wires by cross-referencing the colours with a thermocouple reference table.

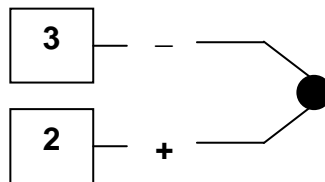

Figure 12. Thermocouple Input Connections

4.12 Universal Input Connections – PT100 (RTD) input

For three wire RTDs, connect the resistive leg and the common legs of the RTD as illustrated. For a two wire RTD a wire link should be used in place of the third wire (shown by dotted line). Two wire RTDs should only be used when the leads are less than 3 metres long. Avoid cable joints.

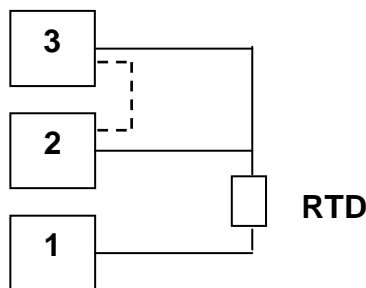

Figure 13. RTD Input Connections

Four wire RTDs can be used, provided that the fourth wire is left unconnected. This wire should be cut short or tied back so that it cannot contact any of the terminals on the rear of the instrument.

4.13 Universal Input Connections - Linear Volt, mV or mA input

Linear DC voltage, millivolt or milliamp input connections are made as illustrated. Carefully observe the polarity of the connections.

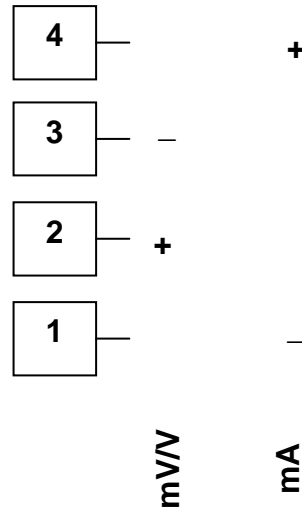

Figure 14. DC Volt, mV & mA Input Connections

4.14 Option Slot 1

Relay Output Module

If option slot 1 is fitted with a relay output module, make connections as illustrated. The relay contacts are rated at 2 amps resistive, 240 VAC (120V max for direct Valve Motor control).

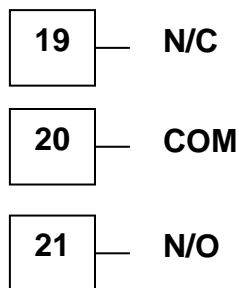

Figure 15. Option Slot 1 – Relay Module Connections

Option Slot 1 - SSR Driver Output Module

If option slot 1 is fitted with an SSR driver output module, make connections as illustrated. The solid-state relay driver is a 0-10V DC signal, load impedance must be no less than 500 ohms. SSR driver outputs are not isolated from the signal input or other SSR driver outputs.

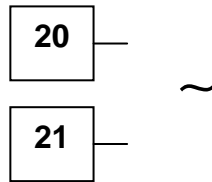

Figure 16. Option Slot 1 - SSR Driver Module Connections

Option Slot 1 - Triac Output Module

If option slot 1 is fitted with a Triac output module, make connections as shown. This output is rated at 0.01 to 1 amp @ 280V AC 50/60Hz. (140V max for direct Valve Motor control).

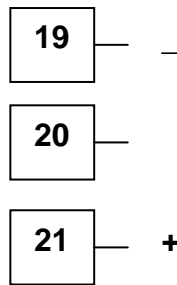

Figure 17. Option Slot 1 - Triac Module Connections

Option Slot 1 - Linear Voltage or mADC Output module

If option slot 1 is fitted with a DC linear output module, make connections as illustrated.

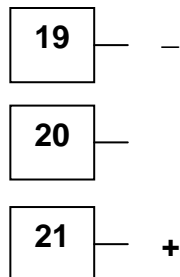

Figure 18. Option Slot 1 - Linear Voltage & mADC Module Connections

4.15 Option Slot 2

Option Slot 2 - Relay Output Module

If option slot 2 is fitted with a relay output module, make connections as illustrated. The relay contacts are rated at 2 amps resistive, 240 VAC (120V max for direct Valve Motor control).

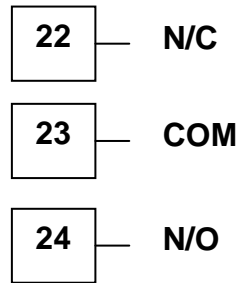

Figure 19. Option Slot 2 - Relay Module Connections

Option Slot 2 - SSR Driver Output Module

If option slot 2 is fitted with an SSR driver output module, make connections as illustrated. The solid-state relay driver is a 0-10V DC signal, load impedance must be no less than 500 ohms. SSR driver outputs are not isolated from the signal input or other SSR driver outputs.

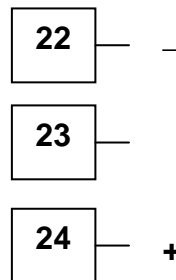

Figure 20. Option Slot 2 - SSR Driver Module Connections

Option Slot 2 - Triac Output Module

If option slot 2 is fitted with a Triac output module, make connections as shown. This output is rated at 0.01 to 1 amp @ 280V AC 50/60Hz. (140V max for direct Valve Motor control).

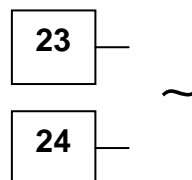

Figure 21. Option Slot 2 - Triac Module Connections

WARNING:

THIS MODULE MUST NOT BE FITTED INTO OPTION SLOT 3.

Option Slot 2 - Linear Voltage or mADC Output module

If option slot 2 is fitted with a DC linear output module, make connections as illustrated.

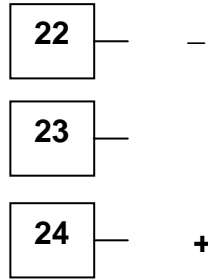

Figure 22. Option Slot 2 - Linear Voltage & mADC module Connections

4.16 Option Slot 3

Option Slot 3 - Relay Output Module

If option slot 3 is fitted with a relay output module, make connections as illustrated. The relay contacts are rated at 2 amps resistive, 240 VAC (120V max for direct Valve Motor control).

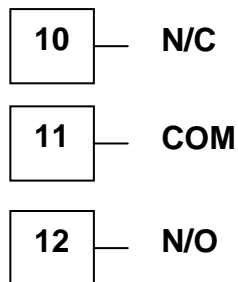

Figure 23. Option Slot 3 - Relay Module Connections

Option Slot 3 - SSR Driver Output Module

If option slot 3 is fitted with an SSR driver output module, make connections as illustrated. The solid-state relay driver is a 0-10V DC signal; load impedance must be no less than 500 ohms. SSR driver outputs are not isolated from the signal input or other SSR driver outputs.

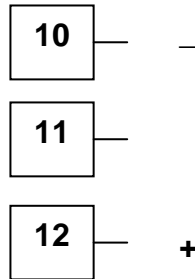

Figure 24. Option Slot 3 - SSR Driver Module Connections

Option Slot 3 - Linear Voltage or mADC Output module

If option slot 3 is fitted with a DC linear output module, make connections as illustrated.

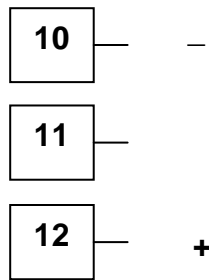

Figure 25. Option Slot 3 - Linear Voltage & mADC Module Connections

Option Slot 3 - Transmitter Power Supply Module

If option slot 3 is fitted with a transmitter power supply module, make connections as illustrated. The output is an unregulated 24V DC, 22mA supply.

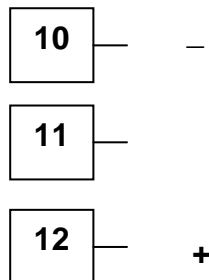

Figure 26. Option Slot 3 - Transmitter Power Supply Module Connections

WARNING:

THIS MODULE MUST NOT BE FITTED INTO OPTION SLOT 2.

4.17 Option Slot A

Option Slot A Connections - RS485 Serial Communications Module

If option slot A is fitted with the RS485 serial communication module, connections are as illustrated. Carefully observe the polarity of the A (Rx/Tx +ve) and B (Rx/Tx -ve) connections.

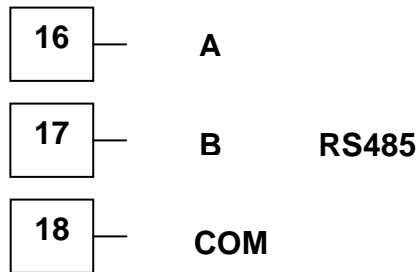

Figure 27. Option Slot A – RS485 Serial Communications Module Connections

Option Slot A Connections - Digital Input Module

If a digital input module is fitted in option slot A, this may be connected to either voltage free contacts (e.g. switch or relay), or a TTL compatible voltage. Connections are shown below.

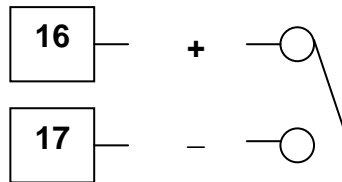

Figure 28. Option Slot A – Digital Input Module Connections

Option Slot A Connections – Basic Auxiliary Input Module

If option slot A is fitted with a basic auxiliary input module, connect as shown. For $\frac{1}{4}$ -DIN & $\frac{1}{8}$ -DIN models it is recommended that the full auxiliary input (Option Slot B) is used instead, as this has additional features and leaves option slot A free for other modules.

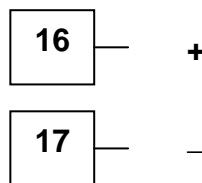

Figure 29. Option Slot A – Basic Auxiliary Input Module Connections

WARNING:

THIS MODULE MUST NOT BE FITTED IF FULL AUXILIARY INPUT IS FITTED IN OPTION SLOT B.

4.18 Option Slot B

Option Slot B Connections – Heater Current Input Module

If the heater current measurement feature is available, connections from the secondary winding of the current transformer are as illustrated below.

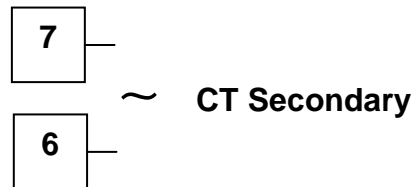

Figure 30. Option Slot B – Heater Current Input Connections

Option Slot B Connections – Digital Input 2 (Full Auxiliary Module)

If option slot B is fitted with the Full Auxiliary input module (see below), a secondary digital input is also provided. This may be connected to either the voltage free contacts of a switch or relay, or a TTL compatible voltage.

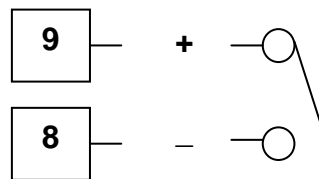

Figure 31. Option Slot B – Digital Input 2 Connections

Option Slot B Connections – 1/4 DIN Full Auxiliary Input Module

If option slot B is fitted with full auxiliary input feature, input connections are as shown.

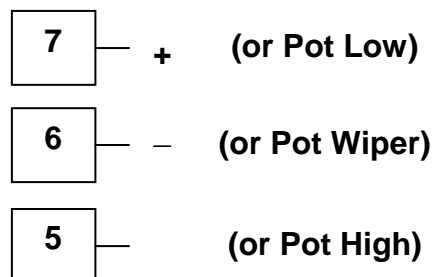

Figure 32. Option Slot B – Full Auxiliary Input Connections

WARNING:

IF THE FULL AUXILIARY MODULE HAS BEEN FITTED, THE BASIC AUXILIARY INPUT MUST NOT BE FITTED INTO OPTION SLOT A.

SECTION 5: POWERING UP

WARNING:

ENSURE SAFE WIRING PRACTICES ARE FOLLOWED

The instrument must be powered from a supply according to the wiring label on the side of the unit. The supply will be either 100 to 240V AC, or 24/48V AC/DC powered. Check carefully the supply voltage and connections before applying power.

CAUTION:

When powering up for the first time, disconnect the output connections.

5.1 Powering Up Procedure

At power up, a self-test procedure is automatically started, during which all LED segments and indicators are lit. At the first power up from new, or if the option modules are changed, **Goto ConF** will be displayed, indicating configuration is required (*refer to section 6*). At all other times, the instrument returns to operator mode once the self-test procedure is complete.

5.2 Overview of Front Panel

The illustration below shows a typical instrument front panel. Refer to the following table – Typical LED functions for a description of the front panel indicators.



Figure 33. Front panel and keys

5.3 Displays







Controllers are provided with a dual line display and LED indicators for mode, automatic tune, alarm and output status. The upper display shows the process variable value during normal operation, while the lower display shows the Setpoint value. See the preceding diagram - Typical front panel and keys.

5.4 Keypad

Each instrument in the range has four switches, which are used to navigate through the user menus and make adjustment to the parameter values. See the preceding diagram - Typical front panel and keys

5.5 LED Functions





Table 3. Typical LED functions

LED	Function
	ON indicates the Setup Mode has been entered <i>(This LED is labelled SET on indicator models)</i>
	FLASHING indicates the manual mode has been entered <i>(On indicator models this LED is labelled SET and flashes when in Configuration Mode)</i>
	ON indicates that Controller Self Tune mode is engaged
	FLASHING indicates that Controller Pre-Tune mode is engaged
	FLASHING indicates that an alarm condition is present
	FLASHES in unison with Time Proportioning Primary outputs, or turns ON with Valve Motor “Open” outputs. For Current Proportioned outputs, ON indicates primary power is >0% It turns ON when the stored Max. PV value is displayed on indicators
	FLASHES in unison with Time Proportioning Secondary outputs, or turns ON with Valve Motor “Close” outputs. For Current Proportioned outputs, ON secondary power is >0% It turns ON when the stored Min. PV value is displayed on indicators

SECTION 6: MESSAGES AND ERROR INDICATIONS

The following displays are shown when an error occurs or a hardware change is detected.

Table 4. Error/Faults conditions

Error/Faults Conditions	Upper display	Lower Display (where fitted)
Configuration & Setup is required. Seen at first turn on or if hardware configuration changed. Press  to enter Configuration Mode, next press  or  to enter the unlock code number, then press  to proceed. Configuration must be completed before return to operator mode is allowed ¹	Goto	ConF
Input more than 5% over-range ²	[HH] *	Normal Display
Input more than 5% under-range ³	[LL] *	Normal Display
Sensor Break. Break detected in the input sensor or wiring	OPEN *	Normal Display
Auxiliary input over-range	Normal Display	[HH] *
Auxiliary input under-range	Normal Display	[LL] *
Auxiliary Break. Break detected in the auxiliary input	Normal Display	OPEN *
Option 1 module fault.	Err	Opn1
Option 2 module fault.	Err	Opn2
Option 3 module fault.	Err	Opn3
Option A module fault.	Err	OpnA
Option B module fault.	Err	Opnb

*** Note**

Input sensor and Auxiliary over/under-range or break indications will be seen wherever these values would normally be displayed.

¹ This feature does not guarantee correct configuration. It only helps to ensure that the unit will be configured before use. Use of set-up mode is not enforced but may be essential for the users application.

² If the PV display exceeds 9999 before 5% over-range is reached, an over-range indication is given.



³ Indicators will allow up to 10% under-range on non-zero based Linear ranges. If the PV display is less than -1999 before the % under-range is reached, an under-range indication is given.

SECTION 7: INSTRUMENT OPERATION MODES



7.1 Select Mode

This mode is used to gain entry to each of the modes available in the instrument.

Entry into the Select Mode

Hold down  and press  in any mode to force the unit to enter Select Mode.

Navigating in Select Mode

Once in Select Mode, press  or  to select the required mode, then press  to enter the chosen mode.

To prevent unauthorised entry to Configuration, Setup and Automatic Tuning modes, an unlock code is required. These are shown in the - Lock code values table.

Table 5. Select Mode Menus

Mode	Description	Upper/Main Display	Lower Display
Operator Mode	The Default Mode on power up used for normal operation.	OPtr	SLCt
Set Up Mode	Used to tailor the instrument to the application, adjustment of tuning terms etc.	SEtP	SLCt
Configuration Mode	Used to configure the instrument for first time use or on re-installation.	ConF	SLCt
Product Information Mode	Used to check the hardware, firmware and manufacturing information of the instrument.	inFo	SLCt
Automatic Tune Mode	Used to invoke pre-tune or self-tune on controllers	Atun	SLCt

Unlock Codes

The **ULoc** screen is seen before entry is allowed to Configuration, Setup and Automatic Tuning modes.



An unlock code must be correctly selected using the  or  keys to enter the required mode. An incorrect entry results in a return to Select Mode. The value of the lock codes only can be changed from within the modes that they apply to.



Table 6. Lock Code – Entry and Default Values

Description	Upper/Main Display	Lower Display
Default values are: Automatic Tune Mode = 0 Set-up mode = 10 Configuration Mode = 20.	0	ULoc

7.2 Automatic Tune Mode

Automatic Tune Mode is selected when it is desired to use the Pre-tune and Self-tune facilities on a controller to assist the user in setting up Proportional band, Integral and Derivative parameter values. Refer to the following Automatic Tune Mode table.

Pre-tune can be used to set Controller PID parameters approximately. Self-tune may then be used to optimise the tuning. Pre-tune can be set to run automatically after every power-up using the Auto Pre-Tune **APt** parameter in Setup Mode.

The **AT** indicator will flash  while pre-tune is operating, and is continuously on  while Self-tune is operating. If both Pre-tune and Self-tune are engaged the **AT** indicator will flash until Pre-tune is finished, and is then continuously on.

Navigating in Automatic Tune Mode

Press  to select the next parameter in the table and  or  to set the value required.

Hold down  and press  to return to Select Mode.

Note:

If there is no key activity for 2 minutes the controller automatically returns to operator mode

Table 7. Automatic Tune Mode Parameters

Parameter	Upper Display Adjustment Range	Lower Display	Default Value	When Visible
Pre-tune	On or OFF . Indication remains OFF if Pre-Tune cannot be used at this time. This applies if: a). The setpoint is ramping b). The process variable is less than 5% of span from the setpoint c). The primary or secondary output proportional bands = 0	Ptun	OFF	Controller models only
Self-tune	On or OFF . Indication remains OFF if Self-Tune cannot be used at this time. This applies if either proportional band = 0.	Stun	OFF	Controller models only
Automatic tune mode lock code	0 to 9999	tLoc	0	Controller models only

7.3 Product Information Mode

This is a read only mode describing the instrument and the options fitted to it.

Navigating in the Product Information Mode

Press  to view each parameter in turn.

Hold Down  and press  to return to Select Mode.

Note:

If there is no key activity for 2 minutes the controller automatically returns to operator mode

Table 8. Product Information Mode Parameters



Parameter	Possible Values	Upper/Main Display	Lower Display
Input type	Universal input	Uni	In_1
Option 1 module type	No option fitted	nonE	OPn1
	Relay	rLY	
	SSR drive	SSr	
	Triac	tri	
	Linear voltage / current output	Lin	

Parameter	Possible Values	Upper/Main Display	Lower Display
Option 2 module type	No option fitted.	nonE	OPn2
	Relay	rLy	
	Dual relay	drLy	
	SSR drive	SSr	
	Triac	tri	
	Linear voltage / current output	Lin	
Option 3 module type	No option fitted.	nonE	OPn3
	Relay	drLy	
	Dual relay	rLy	
	SSR drive	SSr	
	Linear voltage / current output	Lin	
	24V Transmitter power supply	dc24	
Auxiliary option A module type	No option fitted	none	OPnA
	RS485 comms	r485	
	Digital input	diGi	
	Basic Auxiliary input	RSPi	
Auxiliary option B module type	No option fitted	none	OPnb
	Full Auxiliary input and digital input 2	RSPi	
Firmware	Value displayed is firmware type number		FUU
Issue No.	Value displayed is firmware issue number		ISS
Product Rev Level	Value displayed is Product Revision Level.		PrL
Date of manufacture	Manufacturing date code (mmyy)		dOM
Serial number 1	First four digits of serial number		Sn1
Serial number 2	Second four digits of serial number		Sn2
Serial number 3	Last four digits of serial number		Sn3

7.4 Lock Code View

In the event that a lock code is forgotten, the instrument lock code values can be seen in the lock code view. In this view the codes are read only, the codes can be changed from the mode to which they apply.

Entry and Navigating in Lock Code View Mode

Press  and  together while the instrument is powering up until the **CLoc** display is shown.

Once in this mode

Press  to step between lock codes.

Note:

If there is no key activity for 2 minutes the instrument returns to Operator Mode. To forcefully exit this view, switch off the instrument.

Table 9. Lock Code View Menu

Lock Code Name	Description	Upper/Main Display	Lower Display
Configuration Lock Code	Read only view of Configuration Lock Code.	Current Value	CLoc
Setup Lock Code	Read only view of Setup Mode Lock Code.	Current Value	SLoc
Automatic Tune Lock Code	Read only view of Automatic Tune Lock Code.	Current Value	tLoc

***Note:**

On Indicators (which have a single line display), this legend is shown for approx 1 second before the Main display value.

SECTION 8: 1400+ CONTROLLER – MODEL GROUP

These controllers combine technical functionality, field flexibility and ease of use to give you the best in comprehensive process control.

Heat/Cool operation	Loop alarm
Auto/Manual Tuning	Remote or Dual setpoint selection options
Two process alarms	RS485 Modbus and ASCII comms option
Ramping setpoint	PC configuration option

8.1 1400+ Controllers - Configuration Mode



This mode is normally used only when the instrument is configured for the first time or when a major change is made to the instruments characteristics. The Configuration Mode parameters must be set as required before adjusting parameters in Setup Mode, or attempting to use the instrument in an application.

Entry into the Configuration Mode

CAUTION:

Adjustments to these parameters should only be performed by personnel competent and authorised to do so.

Configuration is entered from Select Mode

Hold down  and press  to force the controller into the Select Mode.

then

Press  or  to navigate to the Configuration Mode option, then press .

Note:

Entry into this mode is security-protected by the Configuration Mode Lock Code. Refer to the Unlock Code section for more details.



Scrolling through Parameters and Values

Press  to scroll through the parameters (parameters are described below).

Note:

Only parameters that are applicable to the hardware options chosen will be displayed.

Changing Parameter Values

Press  to navigate to the required parameter, then press  or  to set the value as required.

Once the value is changed, the display will flash to indicate that confirmation of the change is required. The value will revert back if not confirmed within 10 seconds.

Press  to accept the change.

Or

Press  to reject the change and to move onto the next parameter.

Hold down  and press  to return to Select Mode.

Note:

If there is no key activity for 2 minutes the instrument returns to the operator mode.

Table 10. 1400+ Configuration Mode Parameters

Parameter	Lower Display	Upper Display	Description	Default Value	When Visible
Input type and Range	InPt	bC	B type: 100 to 1824 °C	JC for Europe	Always
		bF	B type: 211 to 3315 °F		
		CC	C type: 0 to 2320 °C	JF for USA	
		CF	C type: 32 to 4208 °F		
		JC	J type: -200 to 1200 °C		
		JF	J type: -328 to 2192 °F		
		J.C	J type: -128.8 to 537.7 °C with decimal point		
		J.F	J type: -199.9 to 999.9 °F with decimal point		
		KC	K type: -240 to 1373 °C		
		KF	K type: -400 to 2503 °F		
		k.C	K type: -128.8 to 537.7 °C with decimal point		
		K.F	K type: -199.9 to 999.9 °F with decimal point		
		LC	L type: 0 to 762 °C		
		LF	L type: 32 to 1403 °F		
		L.C	L type: 0.0 to 537.7 °C with decimal point		

Parameter	Lower Display	Upper Display	Description	Default Value	When Visible
		L.F	L type: 32.0 to 999.9 °F with decimal point		

Parameter	Lower Display	Upper Display	Description	Default Value	When Visible
Input type and Range (continued)		NC	N type: 0 to 1399 °C	JC for Europe	Always
		NF	N type: 32 to 2551 °F		
		rC	R type: 0 to 1759 °C	JF for USA	
		rF	R type: 32 to 3198 °F		
		SC	S type: 0 to 1762 °C		
		SF	S type: 32 to 3204 °F		
		tC	T type: -240 to 400 °C		
		tF	T type: -400 to 752 °F		
		t.C	T type: -128.8 to 400.0 °C with decimal point		
		t.F	T type: -199.9 to 752.0 °F with decimal point		
		P24C	PtRh20% vs PtRh40%: 0 to 1850 °C		
		P24F	PtRh20% vs PtRh40%: 32 to 3362 °F		
		PTC	Pt100: -199 to 800 °C		
		PtF	Pt100: -328 to 1472 °F		
		Pt.C	Pt100: -128.8 to 537.7 °C with decimal point		
		Pt.F	Pt100: -199.9 to 999.9 °F with decimal point		
		0_20	0 to 20mA DC		
		4_20	4 to 20mA DC		
		0_50	0 to 50mV DC		
		10.50	10 to 50mV DC		
0_5	0 to 5V DC				
1_5	1 to 5V DC				
0_10	0 to 10V DC				

Parameter	Lower Display	Upper Display	Description	Default Value	When Visible
		2_10	2 to 10V DC		
Scale Range Upper Limit	ruL	Scale Range Lower Limit +100 to Range Max		Linear inputs = 1000 (°C/F inputs = max range)	Always
Scale Range Lower Limit	rLL	Range Min. to Scale range Upper Limit - 100		Linear = 0 (°C/F = min range)	Always
Decimal point position	dPoS	0	Decimal point position in non-temperature ranges. 0 = XXXX 1 = XXX.X 2 = XX.XX 3 = X.XXX	1	Inpt = mV, V or mA
		1			
		2			
		3			
Control Type	CtYP	SnGL	Primary control	SnGL	Always
		duAL	Primary and Secondary control (e.g. for heat & cool)		
Primary Output Control Action	CtRL	reu	Reverse Acting	reu	Always
		dir	Direct Acting		
Alarm 1Type	ALA1	P_Hi	Process High Alarm	P_Hi	Always
		P_Lo	Process Low Alarm		
		dE	Deviation Alarm		
		bAnd	Band Alarm		
		nonE	No alarm		
Process High Alarm 1 value*	PhA1	Range Min. to Range Max. <i>Parameter repeated in Setup Mode</i>		Range Max.	ALA1 = P_Hi
Process Low Alarm 1 value*	PLA1	Range Min. to Range Max <i>Parameter repeated in Setup Mode</i>		Range Min.	ALA1 = P_Lo
Deviation Alarm 1 Value*	dAL1	±span from setpoint <i>Parameter repeated in Setup Mode</i>		5	ALA1 = dE
Band Alarm 1 value*	bAL1	1 LSD to full span from setpoint. <i>Parameter repeated in Setup Mode</i>		5	ALA1 = bAnd
Alarm 1 Hysteresis*	AHY1	1 LSD to 100% of span (in display units) on "safe" side of alarm point. <i>Parameter repeated in Setup Mode</i>		1	Always
Alarm 2 Type	ALA2	As for alarm 1 type		P_Lo	Always
Process High Alarm 2 value*	PhA2	Range Min. to Range Max. <i>Parameter repeated in Setup Mode</i>		Range Max.	ALA2 = P_Hi

Parameter	Lower Display	Upper Display	Description	Default Value	When Visible
Process Low Alarm 2 value*	PLA2	Range Min. to Range Max. <i>Parameter repeated in Setup Mode</i>		Range Min.	ALA2 = P_Lo
Deviation Alarm 2 Value*	dAL2	\pm span from setpoint. <i>Parameter repeated in Setup Mode</i>		5	ALA2 = dE
Band Alarm 2 value*	bAL2	1 LSD to full span from setpoint. <i>Parameter repeated in Setup Mode</i>		5	ALA2 = b And
Alarm 2 Hysteresis*	AHY2	1 LSD to 100% of span (in display units) on "safe" side of alarm point. <i>Parameter repeated in Setup Mode</i>		1	Always
Loop Alarm Enable	LAEn	disA (disabled) or EnAb (enabled)		disA	Always
Loop Alarm Time*	LATi	1 sec to 99 mins. 59secs Only applies if primary proportional band = 0		99.59	LAEn = EnAb
Alarm Inhibit	Inhi	none	No alarms Inhibited	none	Always
		ALA1	Alarm 1 inhibited		
		ALA2	Alarm 2 inhibited		
		both	Alarm 1 and alarm 2 inhibited		
Output 1 Usage	USE1	Pri	Primary Power	Pri	Opn1 is not none
		Sec	Secondary Power		<i>Not linear</i>
		Al_d	Alarm 1, Direct Acting		<i>Not linear</i>
		A1_r	Alarm 1, Reverse Acting		<i>Not linear</i>
		A2_d	Alarm 2, Direct Acting		<i>Not linear</i>
		A2_r	Alarm 2, Reverse Acting		<i>Not linear</i>
		LP_d	Loop Alarm, Direct Acting		<i>Not linear</i>
		LP_r	Loop Alarm, Reverse Acting		<i>Not linear</i>
		Or_d	Logical Alarm 1 OR Alarm 2 Direct Acting		<i>Not linear</i>
		Or_r	Logical Alarm 1 OR Alarm 2 Reverse Acting		<i>Not linear</i>
		Ar_d	Logical Alarm 1 AND Alarm 2, Direct Acting		<i>Not linear</i>
		Ar_r	Logical Alarm 1 AND Alarm 2, Reverse Acting		<i>Not linear</i>
		retS	Retransmit SP Output		<i>Linear only</i>
		retP	Retransmit PV Output		<i>Linear only</i>
Linear Output	tYP1	0_5	0 to 5 V DC output 1	0_10	Opn1 =

Parameter	Lower Display	Upper Display	Description	Default Value	When Visible
1 Range		0_10	0 to 10 V DC output		Lin
		2_10	2 to 10 V DC output		
		0_20	0 to 20 mA DC output		
		4_20	4 to 20 mA DC output		
Retransmit Output 1 Scale maximum	ro1H	–1999 to 9999 Display value at which output will be maximum		Range max	Use1 = retS or retP
Retransmit Output 1 Scale minimum	ro1L	–1999 to 9999 Display value at which output will be minimum		Range min	Use1 = retS or retP
Output 2 Usage	USE2	As for output 1		Sec if dual control selected else A2_d	Opn2 is not none
Linear Output 2 Range	tYP2	As for output 1		0_10	Opn2 = Lin
Retransmit Output 2 Scale maximum	ro2H	–1999 to 9999 Display value at which output will be maximum		Range max	Use2 = retS or retP
Retransmit Output 2 Scale minimum	ro2L	–1999 to 9999 Display value at which output will be minimum		Range min	Use2 = retS or retP
Output 3 Usage	USE3	As for output 1		AI_d	Opn3 is not none
Linear Output 3 Range	tYP3	As for output 1		0_10	Opn3 = Lin
Retransmit Output 3 Scale maximum	ro3H	–1999 to 9999 Display value at which output will be maximum		Range max	Use3 = retS or retP
Retransmit Output 3 Scale minimum	ro3L	–1999 to 9999 Display value at which output will be minimum		Range min	Use3 = retS or retP
Display Strategy	disp	1, 2, 3, 4, 5 or 6 (see Operator Mode)		1	Always
Comms Protocol	Prot	ASCI	ASCII	Mbn	OpnA = r485
		Mbn	Modbus with no parity		
		MbE	Modbus with Even Parity		
		Mbo	Modbus with Odd Parity		

Parameter	Lower Display	Upper Display	Description	Default Value	When Visible
Bit rate	bAud	1.2	1.2 kbps	4.8	OpnA = r485
		2.4	2.4 kbps		
		4.8	4.8 kbps		
		9.6	9.6 kbps		
		19.2	19.2 kbps		
Communications Address	Addr	1	Unique address assigned to the instrument in the range of 1 to 255 (Modbus), 1 to 99 (Ascii)	1	OpnA = r485
Communications Write Enable	CoEn	r_o	Read only. Comms writes ignored	r_W	Always
		r_W	Read / Write. Writing via Comms is possible		
Digital Input 1 Usage	diGi	diS1	Setpoint 1 / Setpoint 2 Select**	diS1	OpnA = diGi
		diAs	Automatic / Manual Select**		
Digital Input 2 Usage	diG2	diS1	Setpoint 1 / Setpoint 2 Select**	dirS	Opnb = rSPi
		diAs	Automatic / Manual Select**		
		dirs	Remote / Local Setpoint Select		
Remote Setpoint Input Range	rinP	0_20	0 to 20mA DC input	0_10	OpnA or Opnb = rSPi
		4_20	4 to 20mA DC input		
		0_10	0 to 10V DC input		
		2_10	2 to 10V DC input		
		0_5	0 to 5V DC input		
		1_5	1 to 5V DC input		
		100	0 to 100mV DC input		
		Pot	Potentiometer ($\geq 2K\Omega$)		
Remote Setpoint Upper Limit	rSPu	-1999 to 9999 RSP value to be used when RSP input is at maximum.		Range max	OpnA = rSPi
Remote Setpoint Lower Limit	rSPL	-1999 to 9999 RSP value to be used when RSP input is at minimum.		Range min	OpnA = rSPi

Parameter	Lower Display	Upper Display	Description	Default Value	When Visible
Remote Setpoint Offset	rSPo		Offset applied to RSP value. Constrained within Scale Range Upper Limit and Scale Range Lower Limit.	0	OpnA = rSPi
Configuration Mode Lock Code	CLoc	0 to 9999		20	Always

***Note:**

*Alarm parameters marked * are repeated in Setup Mode.*

****Note:**

If diGi or diG2 = diS1 the remote setpoint input feature is disabled. The instrument uses the two internal setpoints (SP1 & SP2) instead.

If diGi and diG2 are set to the same value, the status of digital input 2 will take precedence over digital input 1.

8.2 1400+ – Setup Mode



This mode is normally selected only after Configuration Mode has been completed, and is used when a change to the process set up is required. It can affect the range of adjustments available in Operator Mode. Using the PC Configurator software, it is possible to configure an Extended Operator Mode. Setup Mode parameters are moved into Operator Mode, and these parameters appear after the normal Operator Mode screen sequence has been completed.

Note:

Entry into Setup Mode is security-protected by the Setup Mode lock code.

Entry into the Setup Mode



Hold down  and press  to enter the Select Mode

Press  or  to navigate to the Setup Mode option, then press  to enter Setup Mode.

Scrolling through Parameters & Values

Press  to scroll through the parameters (refer to the table below) and their values.

Changing Parameter Values

Press  to select the required parameter, then press  or  to set the value as required.

Once the displayed value is changed the effect is immediate. No confirmation of the change is required.

Note:

If there is no key activity for two minutes the instrument returns to the operator mode.

Table 11. 1400+ Set Up Mode Parameters

Parameter	Lower Display	Upper Display Adjustment Range	Default Value	When Visible
Input Filter Time constant	FiLt	OFF, 0.5 to 100.0 secs in 0.5 sec increments	2.0	Always
Process Variable Offset	OFFS	±Span of controller	0	Always
Primary Power	PPW	The current Primary Output Power. Read Only.	N/A	Always
Secondary Power	SPW	The current Secondary Output power. Read Only.	N/A	Ctyp = duAL
Primary Output Proportional Band	Pb_P	0.0% (ON/OFF control) and 0.5% to 999.9% of input span.	10.0	Always
Secondary Output Proportional Band	Pb_S	0.0% (ON/OFF control) and 0.5% to 999.9% of input span.	10.0	Ctyp = duAL
Automatic Reset (Integral Time Constant)	Arst	0.01 to 99.59 (1 sec to 99 mins 59 secs) and OFF	5.00	Pb_P is not 0.0
Rate (Derivative Time Constant)	rATE	0.00 to 99.59 (OFF to 99 mins 59 secs)	1.15	Pb_P is not 0.0
Overlap/Deadband	OL	-20% to +20% of the sum of the Primary and Secondary Proportional Bands	0	Pb_P is not 0.0
Manual Reset (Bias)	biAS	0% to 100% (-100% to 100% if Ctyp = duAL)	25	Pb_P is not 0.0
Primary Output ON/OFF Differential	diFP	0.1% to 10.0% of input span (enter in % span)	0.5	Pb_P = 0.0
Secondary Output ON/OFF Differential	diFS	0.1% to 10.0% of input span (enter in % span)	0.5	Pb_S = 0.0
Primary and Secondary Output ON/OFF Differential	diFF	0.1% to 10.0% of input span (enter in % span)	0.5	Pb_P and Pb_S = 0.0
Setpoint Upper Limit	SPuL	Current Setpoint value to Scale Range Maximum	Range Max.	Always
Setpoint Lower limit	SPLL	Scale Range Minimum to current Setpoint value	Range Min	Always
Primary (Heat) Output Upper Power Limit	OPuL	0% to 100% of full power	100	Pb_P is not 0.0
Output 1 Cycle Time	CT1	0.5, 1, 2, 4, 8, 16, 32, 64, 128, 256 or 512 secs. Not applicable to linear outputs	32	USE1 = Pri or Sec or bus

Parameter	Lower Display	Upper Display Adjustment Range	Default Value	When Visible
Output 2 Cycle Time	CT2	0.5, 1, 2, 4, 8, 16, 32, 64, 128, 256 or 512 secs. Not applicable to linear outputs	32	USE2 = Pri or Sec or bus
Output 3 Cycle Time	CT3	0.5, 1, 2, 4, 8, 16, 32, 64, 128, 256 or 512 secs. Not applicable to linear outputs	32	USE3 = Pri or Sec or bus
Process High Alarm 1 value*	PhA1	Range Min. to Range Max.	Range Max.	ALA1 = P_Hi
Process Low Alarm 1 value*	PLA1	Range Min. to Range Max.	Range Min.	ALA1 = P_Lo
Deviation Alarm 1 Value*	dAL1	±span from setpoint	5	ALA1 = dE
Band Alarm 1 value*	bAL1	1 LSD to full span from setpoint.	5	ALA1 = bAnd
Alarm 1 Hysteresis*	AHY1	Up to 100% of span	1	Always
Process High Alarm 2 value*	PhA2	Range Min. to Range Max.	Range Max.	ALA2 = P_Hi
Process Low Alarm 2 value*	PLA2	Range Min. to Range Max.	Range Min.	ALA2 = P_Lo
Deviation Alarm 2 Value	dAL2	±span from setpoint	5	ALA2 = dE
Band Alarm 2 value*	bAL2	1 LSD to full span from setpoint.	5	ALA2 = bAnd
Alarm 2 Hysteresis*	AHY2	Up to 100% of span	1	Always
Loop Alarm Time*	LATi	1 sec to 99 mins. 59secs. Only applies if primary proportional band = 0	99.59	LAEn = EnAb
Auto Pre-tune enable / disable	APT	diSA disabled or EnAb enabled	diSA	Always
Manual Control select enable / disable	PoEn	diSA disabled or EnAb enabled	diSA	Always
Setpoint Select shown in Operator Mode, enable / disable	SSEn	diSA disabled or EnAb enabled	diSA	Slot A or B fitted with RSP module
Setpoint ramp shown in operator mode, enable / disable	Spr	diSA disabled or EnAb enabled	diSA	Always
SP Ramp Rate Value	rP	1 to 9999 units/hour or Off (blank)	<i>Blank</i>	Always

Parameter	Lower Display	Upper Display Adjustment Range	Default Value	When Visible
Setpoint Value	SP	Within scale range upper and lower limits	Range minimum	Always

Local Setpoint Value	LSP _LSP or *LSP	Within scale range upper and lower limits. _ or * before the legend indicates if this is the currently active SP	Range minimum.	OpnA or Opnb = rSPi
Setpoint 1 Value	SP1 _SP1 or *SP1	Within scale range upper and lower limits. _ or * before the legend indicates if this is the currently active SP	Range minimum.	diGi or diG2 = diS1
Setpoint2 Value	SP2 _SP2 or *SP2	Within scale range upper and lower limits. _ or * before the legend indicates if this is the currently active SP	Range minimum.	diGi or diG2 = diS1
Set-up Lock Code	SLoc	0 to 9999	10	Always
**First Operator mode displays follows.				

Note:

*Alarm parameters marked * are repeated in Configuration Mode.*

Note:

***Once the complete list of Set Up Mode parameters has been displayed, the first Operator Mode display is shown without exiting from Set Up Mode. Display seen is dependant on the Display Strategy and status of Auto/Manual mode selection.*

8.3 1400+ Controllers - Operator Mode

This is the mode used during normal operation of the instrument. It can be accessed from Select Mode, and is the usual mode entered at power-up. The available displays are dependent upon whether Dual or Remote Setpoint modes are being used, whether Setpoint Ramping is enabled and the setting of the Display Strategy parameter in Configuration Mode.

WARNING:

IN NORMAL OPERATION, THE OPERATOR MUST NOT REMOVE THE CONTROLLER FROM ITS HOUSING OR HAVE UNRESTRICTED ACCESS TO THE REAR TERMINALS, AS THIS WOULD PROVIDE POTENTIAL CONTACT WITH HAZARDOUS LIVE PARTS.

CAUTION:



Set all Configuration Mode parameters and Set Up Mode parameters as required before starting normal operations.

1400+ Controllers – Extended Operator Mode

Using the PC configuration software, it is possible to extend the Operator Mode displays available by adding parameters from Setup Mode. When an extended Operator Mode is configured the additional parameters are available after the standard operator displays.

Navigating in Operator Mode

Press  to move between displays.

When a display value can be adjusted, use  or  to change its value.

Note:

The operator can freely view the parameters in this mode, but alteration depends on the settings in the Configuration and Set Up Modes. All parameters in Display strategy 6 are read only, and can only be adjusted via Setup mode.

Table 12. 1400+ Operator Mode Displays

Upper Display	Lower Display	When Visible	Description
PV Value	Active SP Value	Display strategy 1 and 2. <i>(Initial Screen)</i>	Process Variable and target value of currently selected Setpoint. <i>Local SP is adjustable in Strategy 2</i>
PV Value	Actual SP Value	Display strategy 3 and 6 <i>(Initial Screen)</i>	Process Variable and actual value of selected Setpoint (e.g. ramping SP value). <i>Read only</i>
PV Value	<i>Blank</i>	Display strategy 4. <i>(Initial Screen)</i>	Shows Process Variable. <i>Read only</i>
Actual SP Value	<i>Blank</i>	Display strategy 5. <i>(Initial Screen)</i>	Shows target value of currently selected Setpoint. <i>Read only</i>
SP Value	SP	Display strategy 1, 3, 4, 5 and 6 if Digital Input is not diSI in config mode and RSP is not fitted	Target value of Setpoint. <i>Adjustable except in Strategy 6</i>
SP1 Value	SP1 or _SP1	If Digital Input is set for dual SP (diSI in config mode).	Target value of Setpoint 1. _SP1 means SP1 is selected as the active Setpoint. <i>Adjustable except in Strategy 6</i>
SP2 Value	SP2 or _SP2	If Digital Input is set for dual SP (diSI in config mode).	Target value of Setpoint 2. _SP2 means SP2 is selected as the active Setpoint. <i>Adjustable except in Strategy 6</i>
Local Setpoint Value	LSP _LSP or *LSP	If Remote Setpoint Input is fitted and Digital Input is not diSI in config mode	Target value of Local Setpoint. _LSP means the local setpoint is selected as the active SP (if the digital input has been overridden, the _* character is lit instead). <i>Adjustable except in Strategy 6</i>
Remote Setpoint Value	rSP _rSP or *rSP	If Remote Setpoint Input is fitted and Digital Input is not diSI in config mode	Target value of Remote Setpoint. _rSP means the remote setpoint is selected as the active SP (if the digital input has been overridden, the _* character is lit instead). <i>Read only</i>
_LSP rSP or diGi	SPS	If Remote Setpoint Input is fitted, Digital Input is not diSI in config mode and SSEn is enabled in Setup mode	Setpoint Select. Selects between Local or Remote Setpoints. LSP = local SP, rSP = remote SP, diGi = selection via digital input (if configured). <i>Note: LSP or rSP will override the digital input (active SP indication changes to *)</i> <i>Adjustable except in Strategy 6</i>
Actual SP Value	SPrP	If a Ramping Setpoint is in use (rP not <i>Blank</i>).	Actual value of selected Setpoint (e.g. ramping SP value). <i>Read only</i>
SP Ramp Rate Value	rP	If SPr (ramping SP) is enabled in Setup	Setpoint ramping rate, in units per hour. Set to <i>Blank</i> (higher than 9999) to turn off

Upper Display	Lower Display	When Visible	Description
		mode.	ramping. <i>Adjustable except in Strategy 6</i>

Active Alarm Status	ALSt	When any alarm is active.  ALM indicator will also flash	Upper display shows which alarm(s) are active. Inactive alarms are blank	
			1	Alarm 1 Active
			2	Alarm 2 Active
			L	Loop Alarm Active



Note:

When an extended Operator Mode is configured the additional parameters are available after the above parameters. Extended Operator Mode parameters can only be configured using the PC software.

Adjusting the Local Setpoint(s)

Setpoints can be adjusted within the limits set by the Setpoint Upper and Lower Limit parameters in Setup. Operator Mode adjustment of Setpoint is not possible if Display Strategy 6 has been selected on Configuration Mode.



Press  to select the adjustable setpoint display

Press  or  to adjust the setpoint to the required value.

8.4 Adjusting the Setpoint Ramp Rate

The ramp rate may be adjusted in the range 1 to 9999 and OFF. Increasing the ramp rate value beyond 9999 will cause the upper display to go blank and setpoint ramping to be switched OFF. Setpoint ramping can be resumed by decreasing the ramp rate to 9999 or less.

Press  to select the adjustable setpoint display

Press  or  to adjust the setpoint to the required value.

WARNING:

THE SETPOINT RAMP FEATURE DISABLES THE PRE-TUNE FACILITY. THE SELF-TUNE FACILITY WILL COMMENCE ONLY AFTER THE SETPOINT HAS COMPLETED THE RAMP.



8.5 Manual Control Mode

To allow manual control to be selected in Operator Mode, **poen** must be enabled in Set Up Mode. Manual Mode can be selected using the front keys or by use of a digital input if one has been fitted and configured for this function.

Selecting/deselecting Manual Control Mode

Press the  key to toggle between Automatic and Manual control.

The  indicator flashes continually in Manual Mode

Press  or  to adjust the output power to the required value.

CAUTION:

The Manual Mode power level can be adjusted from 0 to 100% (-100 to +100% for dual output). It is not restricted by the Output Power Limit parameter OPuL.

Note:

Disabling **poen** in Set Up Mode while manual control mode is active will lock the controller into manual mode. Pressing the Auto/Man key will no longer cause a return to automatic control. To exit from Manual Mode, **poen** must temporarily be re-enabled.

8.6 1400+ Controllers –Communications Parameters

The Modbus parameter addresses, and the possible ASCII message types and parameter indents for the 1400+ are detailed below. RO indicates a parameter is read only, R/W indicates it can also be written to. Communications writes will not implemented if the Communications Write Parameter is disabled. Refer to the Modbus and ASCII Communications sections of this manual for details of the protocols used.

Bit Parameters

Bit parameters are not applicable to the ASCII protocol.

Table 13. 1400+ Communications - Bit Parameters

Parameter	Modbus Parameter No.		Notes
Communication Write Status	1	RO	1 = Write Enabled, 0 = Write Disabled. A negative acknowledgement (exception code 3) is sent to write commands if communications writes are disabled
Auto / Manual	2	R/W	1 = Manual Control, 0 = Automatic Control
Self Tune	3	R/W	1 = Activate(d), 0 = Dis-engage(d)
Pre tune	4	R/W	1 = Activate(d), 0 = Dis-engage(d)

Parameter	Modbus Parameter No.		Notes
Alarm 1 Status	5	RO	1 = Active, 0 = Inactive
Alarm 2 Status	6	RO	1 = Active, 0 = Inactive
Setpoint Ramping	7	R/W	1 = Enable(d), 0 = Disable(d)
Loop Alarm Status	10	R/W	1 = Active/Enable, 0 = Inactive/Disable
Loop Alarm	12	R/W	Read to get loop alarm status. Write 0/1 to disable/enable.
Digital Input 2	13	RO	State of Option B digital input.

To set the bit value to 1 write FF, to set the bit value to 0 write 00. Refer to Function Code 05 in the Modbus Communications section.

Word Parameters

Table 14. 1400+ Communications - Word Parameters

Parameter	Modbus Parameter No.		ASCII Ident & Message Types		Notes
Process Variable	1	RO	M Type 2	RO	Current value of PV.
					If under-range = 62976 (<??>5 ASCII)
					If over-range = 63232 (<??>0 ASCII)
					If Sensor break = 63488 (ASCII = n/a)
Setpoint	2	R/W	S Type 2 Type 3/4	RO R/W	Value of currently selected setpoint. (Target setpoint if ramping). Parameter is read only if the current setpoint is RSP.
Output Power	3	R/W	W Type 2 Type 3/4	RO R/W	0% to 100% for single output; -100% to +100% for dual output control. Read Only if not in manual control.
Deviation	4	RO	V Type 2	RO	Difference between Process Variable and Setpoint (value = PV-SP)
Secondary Proportional Band	5	R/W	U Type 2, 3/4	R/W	Adjustable 0.0% to 999.9% of input span. Read only when Self-Tuning.
Primary Proportional Band	6	R/W	P Type 2, 3/4	R/W	Adjustable 0.0% to 999.9% of input span. Read only when Self-Tuning.
Direct / Reverse Acting	7	R/W			1 = Direct Acting, 0 = Reverse
Automatic Reset Time (or Loop Alarm Time)	8	R/W	I Type 2, 3/4	R/W	Integral Time Constant value. (or Loop Alarm Time value in ON/OFF control mode if Loop Alarm Enabled) Read only if Self-Tuning. ASCII range: 0 to 99m 59sec (99.59) Modbus range: 0 to 5999

Parameter	Modbus Parameter No.		ASCII Ident & Message Types		Notes
Rate	9	R/W	D Type 2, 3/4	R/W	Derivative Time Constant value. Read only if Self-Tuning. ASCII range: 0 to 99m 59secs. (99.59) Modbus range: 0 to 5999
Output 1 Cycle time	10	R/W	N Type 2 Type 3/4	RO R/W	0.5, 1, 2, 4, 8, 16, 32, 64,128, 256 or 512 seconds.
Scale Range Lower Limit	11	R/W	H Type 2 Type 3/4	RO R/W	Lower limit of scaled input range
Scale Range Upper Limit	12	R/W	G Type 2 Type 3/4	RO R/W	Upper limit of scaled input range
Alarm 1 Value	13	R/W	C Type 2, 3/4	R/W	Alarm 1 active at this level
Alarm 2 Value	14	R/W	E Type 2, 3/4	R/W	Alarm 2 active at this level
Manual Reset	15	R/W	J Type 2, 3/4	R/W	Bias value. 0% to 100% for single control output or -100% to +100% for dual outputs
Overlap / Deadband	16	R/W	K Type 2, 3/4	R/W	20% to +20% of PB_P + PB_S ; Negative value = Deadband Positive value = Overlap
On / Off Differential	17	R/W	F Type 2, 3/4	R/W	0.1% to 10.0% of input span Used for Primary output on/off differential and for combined Primary and Secondary on/off differential.
Decimal Point Position	18	R/W	Q Type 2 Type 3/4	RO R/W	0 = xxxx 1 = xxx.x 2 = xx.xx 3 = x.xxx Read only if not Linear Input.
Output 2 Cycle Time.	19	R/W	O Type 2 Type 3/4	RO R/W	0.5, 1, 2, 4, 8, 16, 32, 64,128, 256 or 512 seconds.
Primary Output Power Limit	20	R/W	B Type 2 Type 3/4	RO R/W	Safety power limit; 0 to 100 %.
Actual Setpoint	21	RO			Current (ramping) value of selected setpoint.
Setpoint Upper Limit	22	R/W	A Type 2 Type 3/4	RO R/W	Maximum setpoint value. Current SP to Input Range Maximum
Setpoint Lower Limit	23	R/W	T Type 2 Type 3/4	RO R/W	Minimum setpoint value. Current SP to Input Range Minimum

Parameter	Modbus Parameter No.		ASCII Ident & Message Types		Notes
Setpoint Ramp Rate	24	R/W	^ Type 2 Type 3/4	RO R/W	0 = Off, 1 to 9999 increments / hour. Dec Point position as for input range.
Input Filter Time Constant	25	R/W	m Type 2, 3/4	R/W	0 to 100 seconds
Process Value Offset	26	R/W	v Type 2 Type 3/4	RO R/W	Modified PV = Actual PV + PV Offset. Limited by Scale Range Maximum and Scale Range Minimum.
Re-transmit Output Maximum	27	R/W	[Type 2, 3/4	R/W	Maximum scale value for retransmit output, 1999 to 9999. This parameter applies to the first re-transmit output fitted (see also Modbus parameters 2214, 2224 & 2234).
Re-transmit Output Minimum	28	R/W	\ Type 2, 3/4	R/W	Minimum scale value for retransmit output, 1999 to 9999. This parameter applies to the first re-transmit output fitted (see also Modbus parameters 2215, 2225 & 2235).
Setpoint 2	29	R/W			Value of Setpoint 2
Remote Setpoint	30	RO			Value of Remote Setpoint. Returns 0FFFFhex if RSP not fitted.
Remote Setpoint Offset	31	R/W	~ Type 2, 3/4	R/W	Modified RSP = Actual RSP + RSP Offset. Limited by Scale Range Maximum and Scale Range Minimum.
Alarm 1 Hysteresis	32	R/W			0 to 100% of span
Alarm 2 Hysteresis	33	R/W			0 to 100% of span
Setpoint 1	34	R/W			Value of Setpoint 1
Setpoint Select	35	R/W			Shows which is the currently selected active setpoint. If a digital input has been configured for Setpoint Select, it will take priority over this parameter 1 = SP1 or LSP 2 = SP2 100hex = RSP

Parameter	Modbus Parameter No.		ASCII Ident & Message Types		Notes
Controller commands			Z Type 3/4	R/W	<p>Only Type 3 / 4 ASCII messages are allowed with this parameter. The {DATA} field must be one of eight five-digit numbers. The commands corresponding to the {DATA} field value are:</p> <ul style="list-style-type: none"> 00010 = Activate Manual Control 00020 = Activate Automatic Control 00030 = Activate the Self-Tune 00040 = De-activate the Self-Tune 00050 = Request Pre-Tune 00060 = Abort Pre-Tune 00130 = Activate Loop Alarm 00140 = De-activate Loop Alarm

Parameter	Modbus Parameter No.		ASCII Ident & Message Types		Notes	
	Bit	Meaning				
Controller Status	L Type 2	RO	0	Alarm 1 status. 0 = activated, 1 = safe		
			1	Alarm 2 status. 0 = activated, 1 = safe		
			2	Self-Tune status. 0 = disabled 1 = activated		
			3	Change Indicator. 1 = A parameter other than controller status, PV or Output power has been changed since the last time the status word was read.		
			4	Comms write status: 0 = disabled 1 = enabled.		
			5	A/M control. 0 = disabled 1 = enabled		
			7	Pre-tune status. 0 = disabled 1 = enabled.		
			8	Loop alarm status. 0 = activated, 1 = safe.		
Scan Table	J Type 2	RO	Reads back main process values. Response is: L{N}25aaaaabbbbb ccccddddddeeeeeA* where: aaaaa = Actual Setpoint value bbbbbb = Process Variable value cccccc = Primary PID Power value dddddd = Secondary PID Power value eeeeee = Controller Status (see above)			
Equipment ID			122	RO	The four digit model number 6100	
Serial Number Low	123	RO	Digits aaaa	Unit serial number. Format aaaa bbbb cccc, (12 BCD digits).		
Serial Number Mid	124	RO	Digits bbbb			
Serial Number High	125	RO	Digits cccc			
Date of manufacture	126	RO	Manufacturing date code as an encoded binary number. (e.g. 0403 for April 2003 is returned as 193hex)			

Parameter	Modbus Parameter No.		ASCII Ident & Message Types		Notes
Product Revision Level	129	RO			Bits 0 – 7: Alpha part of PRL. (e.g. A = 01hex) Bits 8 – 15: Numeric part of PRL. (e.g. 13 = 0Dhex)
Firmware Version	130	RO			Bits 0 – 4: Revision number (1,2...) Bits 5 – 9: Alpha version (A=0, B=1...) Bits 10 – 15: Numeric version (starting from 121 = 0)
Input status	133	RO			Input status. Read Only. Bit 0: Sensor break flag Bit 1: Under-range flag Bit 2: Over-range flag
Remote Setpoint Lower Limit	2123	R/W	Y Type 2, 3/4	R/W	RSP value to be used when RSP input is at minimum. -1999 to 9999
Remote Setpoint Upper Limit	2124	R/W	X Type 2, 3/4	R/W	RSP value to be used when RSP input is at minimum. -1999 to 9999
Option Slot 1 Re-transmit output Maximum	2214	R/W			Maximum scale value for retransmit output in slot 1, -1999 to 9999.
Option Slot 1 Re-transmit output Minimum	2215	R/W			Minimum scale value for retransmit output in slot 1, -1999 to 9999.
Option Slot 2 Re-transmit output Maximum	2224	R/W			Maximum scale value for retransmit output in slot 2, -1999 to 9999.
Option Slot 2 Re-transmit output Minimum	2225	R/W			Minimum scale value for retransmit output in slot 2, -1999 to 9999.
Option Slot 3 Re-transmit output Maximum	2234	R/W			Maximum scale value for retransmit output in slot 3, -1999 to 9999.
Option Slot 3 Re-transmit output Minimum	2235	R/W			Minimum scale value for retransmit output in slot 3, -1999 to 9999.

Note:

Some of the parameters that do not apply for a particular configuration will accept reads and writes (e.g. attempting to scale a Linear output which has not been fitted). Read only parameters will return an exception if an attempt is made to write values to them.

SECTION 9: MANUALLY TUNING CONTROLLERS

9.1 Single Control Tuning (PID with Primary Output only)

This simple technique balances the need to reach setpoint quickly, with the wish to limit setpoint overshoot at start-up or during process changes. It determines values for the Primary Proportional Band (**Pb_P**), Integral Time Constant (**ArSt**) and Derivative Time Constant (**rAte**) that allow the PID control algorithm to give acceptable results in most applications that use a single control device.

CAUTION:

This technique is suitable only for processes that are not harmed by large fluctuations in the process variable.

1. Check that the Setpoint Upper Limit (**SPuL**) and Setpoint Lower Limit (**SPLl**) are set to safe levels for your process. Adjust if required.
2. Set the Setpoint to the normal operating value for the process (or to a lower value if overshoots beyond this value might cause damage).
3. Select On-Off control (i.e. set **Pb_P** = 0).
4. Switch on the process. The process variable will oscillate about the setpoint. Record the Peak-to-Peak variation (**P**) of the first cycle (i.e. the difference between the highest value of the first overshoot and the lowest value of the first undershoot), and the time period of the oscillation (**T**) in minutes. See the example diagram below - Manually Tuning PID.
5. Calculate the PID control parameters using the formula below. Input Span is the difference between Scale Range Lower Limit and Scale Range Upper Limit:

$$Pb_P = \frac{P}{\text{Input Span}} \times 100$$

$$ArSt = T \text{ min}$$

$$rATE = \frac{T}{6} \text{ minutes}$$

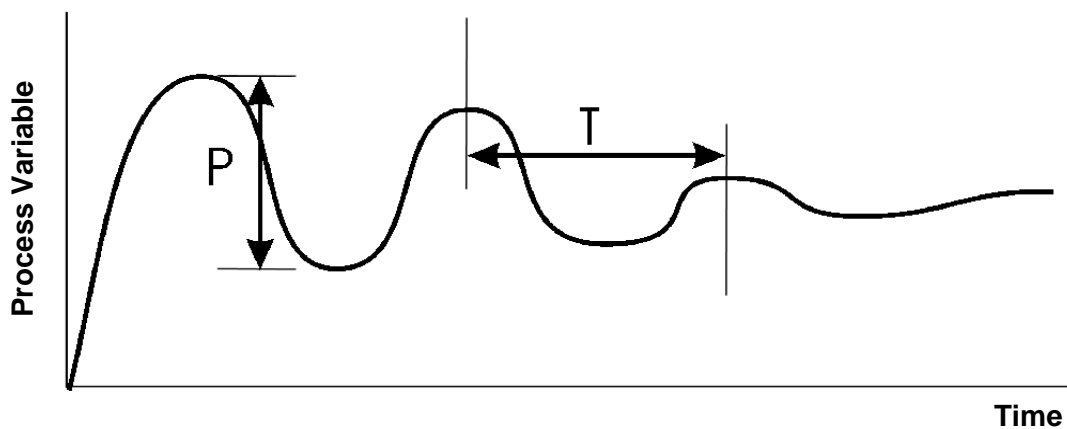

Figure 34. Manually Tuning PID

9.2 Dual Control Tuning (PID with Primary and Secondary Outputs)

This simple tuning technique balances the need to reach setpoint quickly, with the wish to limit setpoint overshoot at start-up and during process changes. It determines values for the Primary Proportional Band (**Pb_P**), Secondary Proportional Band (**Pb_S**), Integral Time Constant (**ArSt**) and Derivative Time Constant (**RAte**) that allow the PID control algorithm to give acceptable results in most applications that use dual control (e.g. Heat & Cool).

CAUTION:

This technique is suitable only for processes that are not harmed by large fluctuations in the process variable.

1. Tune the controller using only the Primary Control output as described in the Single Control Tuning section above.
2. Set **Pb_S** to the same value as **Pb_P** and monitor the operation of the controller in dual control mode. If there is a tendency to oscillate as the control passes into the Secondary Proportional Band, increase the value of **Pb_S**. If the process appears to be over-damped in the region of the Secondary Proportional Band, decrease the value of **Pb_S**.
3. When the PID tuning values have been determined, if there is a kick to the process variable as control passes from one output to the other, set the Overlap/Deadband parameter to a positive value to introduce some overlap. Adjust this value by trial and error until satisfactory results are obtained.

9.3 Valve Control Tuning (PI with Linear Outputs)

This tuning technique is used when controlling a modulating valve requiring a linear (mA/VDC) signal for its positioning circuitry. It determines values for the Primary Proportional Band (**Pb_P**), and Integral Time Constant (**ArSt**). The Derivative Time Constant (**RAte**) is normally set to zero (OFF). This PI Control minimises valve wear while giving optimal process control.

CAUTION:

This technique is suitable only for processes that are not harmed by large fluctuations in the process variable.

1. Set the setpoint to the normal operating process value (or to a lower value if overshoot beyond this value is likely to cause damage).
2. Set the Primary Proportional Band to the minimum value (i.e. set **Pb_P** = 0.5%).
3. Set the Integral Time Constant to the maximum value (i.e. set **ArSt** = 99.59).
4. Set the Derivative Time Constant to OFF (i.e. set **RAte** = 0.00).
5. Using manual control ensure that the valve is positioned away from its end stops.

6. Follow the instructions in the diagram below. At each stage, allow sufficient settling time before moving on to the next stage.

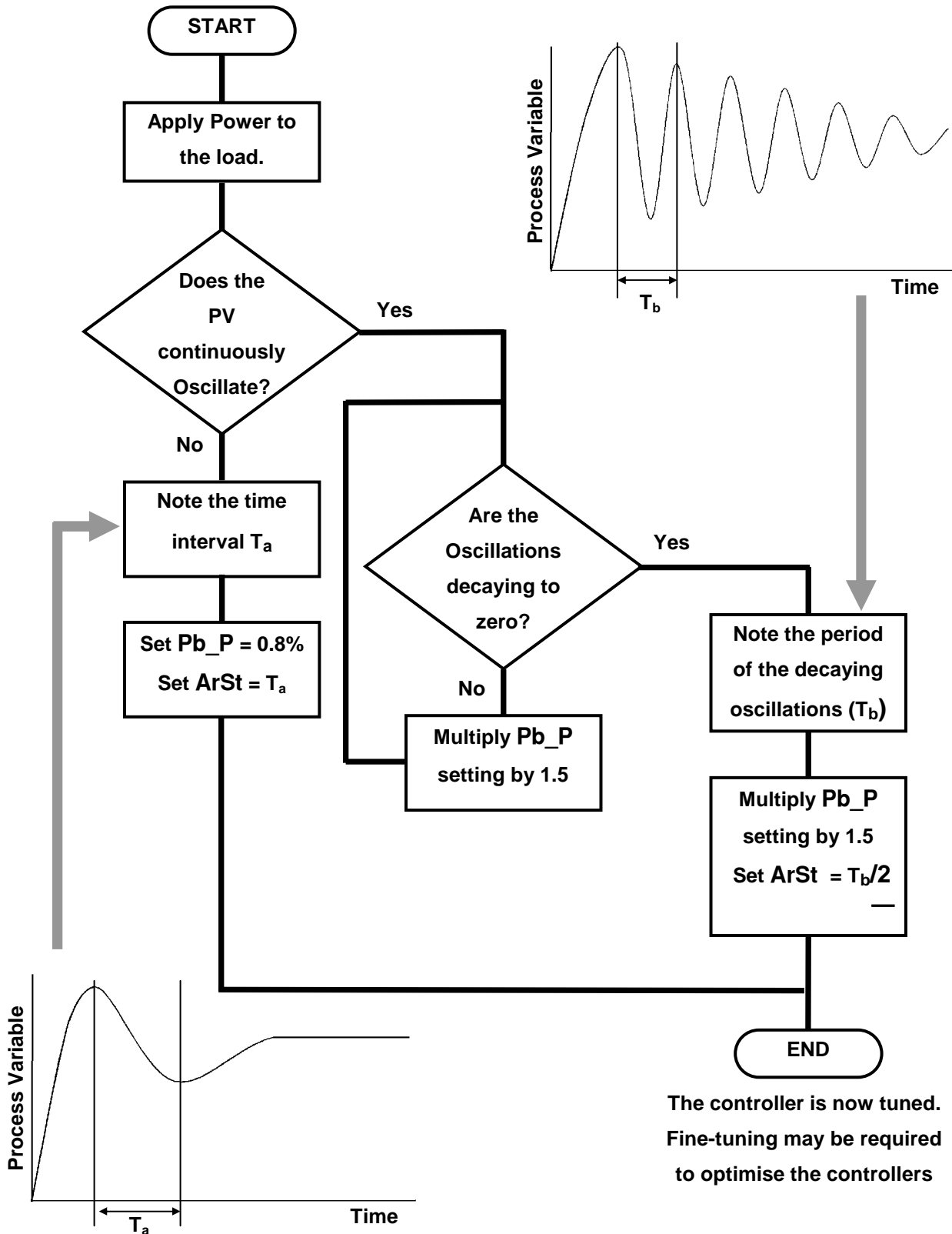

Table 15. Manually Tuning Valve Control

9.4 Manually Fine Tuning

A separate cycle time adjustment parameter is provided for each time proportioning control output.

Note:

Adjusting the cycle time affects the controllers operation; a shorter cycle time gives more accurate control but electromechanical components such as relays have a reduced life span.

1. Increase the width of the proportional band if the process overshoots or oscillates excessively.
2. Decrease the width of the proportional band if the process responds slowly or fails to reach setpoint.
3. Increase the automatic reset until the process becomes unstable, then decrease until stability has been restored.

Note:

Allow enough time for the controller and process to adjust.

4. Initially add rate at a value between 1/4th and 1/10th of the automatic reset value.
5. Decrease Rate if the process overshoots/undershoots or oscillates excessively.

Note:

When controlling a modulating valve, it is recommended that Rate (Derivative) is set to 0 seconds (OFF) to avoid excessive valve activity.

Rate can cause process instability.

6. After making all other adjustments, if an offset exists between the setpoint and the process variable use the Bias (manual reset) to eliminate the error:
Below setpoint - use a larger bias value
Above setpoint - use a smaller bias value.

SECTION 10: MODBUS SERIAL COMMUNICATIONS

All models support the Modbus RTU communication protocol. Some models also support an ASCII communication protocol. Where both Modbus and ASCII are supported, the protocol to be used is selected from Configuration Mode. The RS485 Communications Module must be fitted into Option Slot A in order to use serial communications.

Refer to the relevant Model Group Section for the ASCII and Modbus Application Layer (parameter address/ident information).

For a complete description of the Modbus protocol refer to the description provided at <http://www.modicon.com/> or <http://www.modbus.org/>

10.1 Physical Layer

The Base address, bit rate and character format are configured via the front panel in Configuration Mode or by using the PC Configurator software.

Physical layer configuration settings possible are:

Data rate: 1200, 2400, 4800 (default), 9600 and 19,200 bps

Parity: None (default), Even, Odd

Character format: Always 8 bits per character.

The transmitter must not start transmission until 3 character times have elapsed since reception of the last character in a message, and must release the transmission line within 3 character times of the last character in a message.

Note:

Three character times = 1.5ms at 19200, 3ms at 9600, 6ms at 4800, 12ms at 2400 and 24ms at 1200 bps.

10.2 Link Layer

A Query (or command) is transmitted from the Modbus Master to the Modbus Slave. The slave instrument assembles the reply to the master. All of the instruments covered by this manual are slave devices, and cannot act as a Modbus Master.

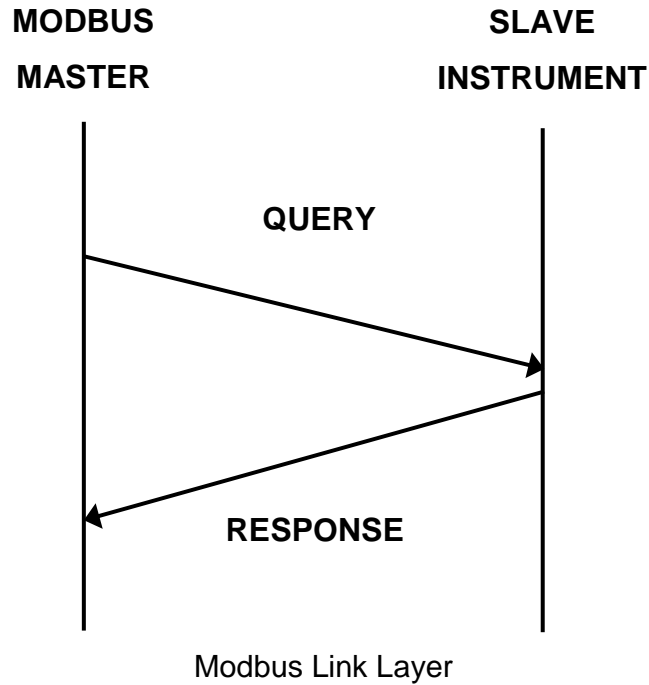

A message for either a QUERY or RESPONSE is made up of an inter-message gap followed by a sequence of data characters. The inter-message gap is at least 3.5 data character times.

Data is encoded for each character as binary data, transmitted LSB first.

For a QUERY the address field contains the address of the slave destination. The slave address is given together with the Function and Data fields by the Application layer. The CRC is generated from the given address, function and data characters.

For a RESPONSE the address field contains the address of the responding slave. The Function and Data fields are generated by the slave application. The CRC is generated from the address, function and data characters.

The standard MODBUS RTU CRC-16 calculation employing the polynomial $2^{16}+2^{15}+2^2+1$ is used.

Inter-message gap	Address 1 character	Function 1 character	Data <i>n</i> characters	CRC Check 2 characters
-------------------	------------------------	-------------------------	-----------------------------	---------------------------

10.3 Device Addressing

The instrument is assigned a unique device address by the user in the range 1 (default) to 255 using the **Addr** parameter in Configuration Mode. This address is used to recognise Modbus Queries intended for this instrument. The instrument does not respond to Modbus Queries that do not match the address that has been assigned to it.

The instrument will also accept global Queries using device address 0 no matter what device address is assigned. No responses are returned for globally addressed Queries.

10.4 Supported Modbus Functions

Modbus defines several function types; these instruments support the following types:

Table 16. Supported Modbus Functions

Function Code (decimal)	Modbus Meaning	Description
01 / 02	Read Coil/Input Status	Read output/input status bits at given address.
03 / 04	Read Holding/Input registers	Read current binary value of specified number of parameters at given address. Up to 64 parameters can be accessed with one Query.
05	Force single Coil	Writes a single binary bit to the Specified Slave Bit address.
06	Pre-set Single Register	Writes two bytes to a specified word address.
08	Diagnostics	Used for loopback test.
16	Pre-set Multiple Registers	Writes up to 1 word parameter values to the specified address range.

10.5 Function Descriptions

The following is interpreted from the Modbus Protocol Description obtainable from <http://www.modicon.com/> or <http://www.modbus.org/>. Refer to that document if clarification is required.

In the function descriptions below, the preceding device address value is assumed, as is the correctly formed two-byte CRC value at the end of the QUERY and RESPONSE frames.

Read Coil/Input Status (Function 01 / 02)

Reads the content of instruments output/input status bits at the specified bit address.

Table 17. Read Coil/Input Status (Modbus Function 01/02)

QUERY

Function	Address of 1st Bit		Number of Bits	
01 / 02	HI	LO	HI	LO

RESPONSE

Function	Number of Bytes	First 8 bits	2nd 8 Bits
01 / 02			

In the response the “Number of Bytes” indicates the number of data bytes read from the instrument. E.g. if 16 bits of data are returned then the count will be 2. The maximum number of bits that can be read is 16 in one transaction. The first bit read is returned in the least significant bit of the first 8 bits returned.

Read Holding/Input Registers (Function 03 / 04)

Reads current binary value of data at the specified word addresses.

Table 18. Read Holding/Input Registers (Modbus Function 03/04)

QUERY

Function	Address of 1 st Word		Number of Words	
03 / 04	HI	LO	HI	LO

RESPONSE

Function	Number of Bytes	First Word		Last Word	
03 / 04		HI	LO	HI	LO

In the response the “Number of Bytes” indicates the number of data bytes read from the instrument. E.g. if 5 words are read, the count will be 10 (A hex). The maximum number of words that can be read is 64. If a parameter does not exist at one of the addresses read, then a value of 0000h is returned for that word.

Force Single Coil (Function 05)

Writes a single binary value to the Specified Instrument Bit address.

Table 19. Force Single Coil (Modbus Function 05)

QUERY				
Function	Address of Bit		State to write	
05	HI	LO	FF/00	00

RESPONSE				
Function	Address of Bit		State written	
05	HI	LO	FF/00	00

The address specifies the address of the bit to be written to. The State to write is FF when the bit is to be SET and 00 if the bit is to be RESET.

Note:

The Response normally returns the same data as the Query.

Pre-Set Single Register (Function 06)

Writes two bytes to a specified word address.

Table 20. Pre-Set Single Register (Modbus Function 06)

QUERY				
Function	Address of Word		Value to write	
06	HI	LO	HI	LO

RESPONSE				
Function	Address of Word		Value written	
06	HI	LO	HI	LO

Note:

The Response normally returns the same data as the Query.

Loopback Diagnostic Test (Function 08)

Table 21. Loopback Diagnostic Test (Modbus Function 08)

QUERY				
Function	Diagnostic Code		Value	
08	HI =00	LO=00	HI	LO

RESPONSE				
Function	Sub-function		Value	
08	HI=00	LO=00	HI	LO

Note:

The Response normally returns the same data as the Query.

Pre-Set Multiple Registers (Function 10 Hex)

Writes a consecutive word (two-byte) value to the specified address range.

Table 22. Pre-Set Multiple Registers (Modbus Function 10 Hex)

QUERY

Function	1 st Word Address		Number of Words		Number of Query Bytes		First value to write	
10	HI	LO	HI	LO			HI	LO

RESPONSE

Function	1st Word Address		Number of Words	
10	HI	LO	HI	LO

Note:

The number of consecutive words that can be written is limited to 1.

Exception Responses

When a QUERY is sent that the instrument cannot interpret then an Exception RESPONSE is returned. Possible exception responses are:

Table 23. Modbus Exception Responses

Exception Code	Error Condition	Interpretation
00	Unused	None.
01	Illegal function	Function number out of range.
02	Illegal Data Address	Write functions: Parameter number out of range or not supported. (for write functions only). Read Functions: Start parameter does not exist or end parameter greater than 65536.
03	Illegal Data Value	Attempt to write invalid data / required action not executed.

The format of an exception response is:

RESPONSE

Function	Exception Code
Original Function code with its Most Significant Bit (MSB) set.	<i>as detailed above</i>

Note:

In the case of multiple exception codes for a single QUERY the Exception code returned is the one corresponding to the first parameter in error.

SECTION 11: ASCII COMMUNICATIONS

This simple ASCII protocol provides backwards compatibility with some older products. ASCII is not available in all models in the range. The Modbus protocol is recommended for future use. Refer to the relevant Model Group Section for the ASCII and Modbus Application Layer (parameter address/ident information).

11.1 Physical Layer

The Base address, bit rate and character format are configured via the front panel in Configuration Mode or by using the PC Configurator software.

Physical layer configuration settings possible are:

Data rate: 1200, 2400, 4800 (default), 9600 and 19,200 bps

Parity: Even

Character format: 7 bits per character. + 1 stop bit.

The transmitter must not start transmission until 3 character times have elapsed since reception of the last character in a message, and must release the transmission line within 3 character times of the last character in a message.

Note:

Three character times = 1.5ms at 19200, 3ms at 9600, 6ms at 4800, 12ms at 2400 and 24ms at 1200 bps.

11.2 Device Addressing

The instrument is assigned a device address by the user using the **Addr** parameter in Configuration Mode. The address may be set to any unique value from 1 (default) to 99. This address is used to recognise ASCII messages intended for this instrument. The instrument does not respond to messages that do not match the address that has been assigned to it.

11.3 Session Layer

The ASCII protocol assumes half duplex communications. The master device initiates all communication. The master sends a command or query to the addressed slave instrument and the slave replies with an acknowledgement of the command or the reply to the query.

Messages from the master device may be one of five types:

Type 1: {S}{N}??*
Type 2: {S}{N}{P}{C}* or R{N}{P}{C}*
Type 3: {S}{N}{P}#{DATA}* or R{N}{P}#{DATA}*
Type 4: {S}{N}{P}I* or R{N}{P}I*
Type 5: {S} {N} \ P S S ? *

All characters are in ASCII code. See the following Parameter Key table for details of the parameters in brackets { }.

Table 24. ASCII Parameter Key

{S}	is the Start of Message character L (Hex 4C) or R (Hex 52). L is used for Controllers; R is used for Profilers.
{N}	is the slave device address (in the range 1 - 99); addresses 1 - 9 may be represented by a single digit (e.g. 7) or in two-digit form, the first digit being zero (e.g. 07).
{P}	is a character which identifies the parameter to be interrogated/modified.
{C}	is the command (Refer to the Serial Communications Application Layer information for each Model Group)
#	indicates that {DATA} is to follow (Hex 23)
{DATA}	is a string of numerical data in ASCII code (refer to the Data Element table below)
P	is the Program Number
S S	is the Segment Number (01 to 16)
*	is the End of Message Character (Hex 2A)

No space characters are permitted in messages. Any syntax errors in a received message will cause the slave instrument to issue no reply and await the Start of Message character.

Table 25. ASCII Data Element – Sign/Decimal Point Position

{DATA} Content	Data Format	Description
abcd0	+abcd	Positive value, no decimal place
abcd1	+abc.d	Positive value, one decimal place
abcd2	+ab.cd	Positive value, two decimal places
abcd3	+a.bcd	Positive value, three decimal places
Abcd5	- abcd	Negative value, no decimal place
Abcd6	- abc.d	Negative value, one decimal place
Abcd7	- ab.cd	Negative value, two decimal places
Abcd8	- a.bcd	Negative value, three decimal places

(in the Data Content, abcd represents the data value, the last digit indicates data format)

Type 1 Message

L {N} ? ? *

This message is used by the master device to determine whether the addressed slave device is active.

The reply from an active slave is

L {N} ? A *

An inactive device will give no reply.

Type 2 Message

L {N} {P} {C} * or R {N} {P} {C} *

This type of message is used by the master device, to interrogate or modify a parameter in the addressed slave device. {P} identifies the parameter and {C} represents the command to be executed, which may be one of the following:

- + (Hex 2B) = Increment the value of the parameter defined by {P}
- (Hex 2D) = Decrement the value of the parameter defined by {P}
- ? (Hex 3F) = Determine the current value of the parameter defined by {P}

The reply from the addressed slave device is of the form:

L {N} {P} {DATA} A * or R {N} {P} {DATA} A *

where {DATA} comprises five ASCII-coded digits whose format is shown in the Data Element table above. The data is the value requested in a query message or the new value of the parameter after modification. If the action requested by the message from the master device would result in an invalid value for that parameter (either because the requested new value would be outside the permitted range for that parameter or because the parameter is not modifiable), the slave device replies with a negative acknowledgement:

L {N} {P} {DATA} N * or R {N} {P} {DATA} N *

The {DATA} string in the negative acknowledgement reply will be indeterminate. If the process variable or the deviation is interrogated while the process variable is outside the range of the slave device, the reply is:

L {N} {P} < ? ? > 0 A *

if the process variable is over-range, or

L {N} {P} < ? ? > 5 A *

if the process variable is under-range.

Type 3 Message

L {N} {P} # {DATA} * or R {N} {P} # {DATA} *

This message type is used by the master device to set a parameter to the value specified in {DATA}. The command is not implemented immediately by the slave device; the slave will receive this command and will then wait for a Type 4 message (see below). Upon receipt of a Type 3 message, if the {DATA} content and the specified parameter are valid, the slave device reply is of the form:

L {N} {P} {DATA} I * or R {N} {P} {DATA} I *

(where I = Hex 49) indicating that the slave device is ready to implement the command. If the parameter specified is invalid or is not modifiable or if the desired value is outside the permitted range for that parameter, the slave device replies with a negative acknowledgement in the form:

L {N} {P} {DATA} N * or R {N} {P} {DATA} N *

Type 4 Message

L {N} {P} I * or R {N} {P} I *

This type of message is sent by the master device to the addressed slave device, following a successful Type 3 transaction with the same slave device. Provided that the **{DATA}** content and the parameter specified in the preceding Type 3 message are still valid, the slave device will then set the parameter to the desired value and will reply in the form:

L {N} {P} {DATA} A *

where **{DATA}** is the new value of the parameter. If the new value or parameter specified is invalid, the slave device will reply with a negative acknowledgement in the form:

L {N} {P} {DATA} N *

where **{DATA}** is indeterminate. If the immediately preceding message received by the slave device was not a Type 3 message, the Type 4 message is ignored.

11.4 Error Response

The circumstances under which a message received from the master device is ignored are:

- Parity error detected
- Syntax error detected
- Timeout elapsed
- Receipt of a Type 4 message without a preceding Type 3 command message.

Negative acknowledgements will be returned if, in spite of the received message being notionally correct, the slave device cannot supply the requested information or perform the requested operation. The **{DATA}** element of a negative acknowledgement will be indeterminate.

SECTION 12: CALIBRATION MODE

WARNING:

CALIBRATION IS ONLY REQUIRED FOR INSTRUMENTS IN WHICH CALIBRATION ERRORS HAVE BEEN ENCOUNTERED. REFER TO CALIBRATION CHECK BELOW.

CAUTION:

Calibration must be performed by personnel who are technically competent and authorised to do so.

Calibration is carried out during manufacture and is not normally required again during the lifetime of an instrument.

12.1 Equipment Required For Checking or Calibrating the Universal Input

A suitable calibration signal source is required for each input type. To verify the accuracy of the instrument or carry out recalibration, the listed input sources are required, with better than $\pm 0.05\%$ of the reading accuracy:

1. DC linear inputs: 0 to 50mV, 0 to 10VDC and 0 to 20mADC.
2. Thermocouple inputs - complete with 0°C reference facility, appropriate thermocouple functions and compensating leads (or equivalent).
3. RTD inputs: decade resistance box with connections for three-wire input (or equivalent).

12.2 Calibration Check

1. Set the instrument to the required input type.
2. Power up the instrument and connect the correct input leads.
Leave powered up for at least five minutes for RTD and DC linear inputs, or at least 30 minutes for thermocouple inputs.
3. After the appropriate delay for stabilisation has elapsed, check the calibration by connecting the appropriate input source and checking a number of cardinal points.
4. Repeat the test for all required input types.

12.3 Recalibration Procedure

Recalibration is carried out in five phases as shown in the table below, each phase corresponds to an input range of the instrument.

CAUTION:

The 50mV phase **MUST** be calibrated before the thermocouple range.

Table 26. Input Calibration phases







iP_1	50 mV
iP_2	10 V
iP_3	20 mA
iP_4	RTD input (200 ohm)
iP_5	Thermocouple (K type source at 0°C required)

To start calibration, apply the required calibration input from the source type list above, using the correct connections,

1. While the instrument is powering up, press  and  together until **iP_1** is displayed.

Note:

If a phase has not been previously calibrated the display will flash.

2. Press  to initiate calibration on PID Controllers, or
Press  to initiate calibration on Limit Controllers, or
Press  and  together to initiate calibration on Indicators.
3. During calibration the display changes to  for a few seconds.
4. If the input is misconnected or an incorrect signal is applied the calibration will be aborted and the display will shown **FAiL**. The previous calibration value will be retained.
5. If the calibration has succeeded, the pass display is shown **iP_1** (non-flashing).
6. Press  to step onto the next phase.
7. Repeat this process for each input type until all the phases are calibrated.

Note:

Switch off the instrument to exit the Calibration Mode.

Calibration Mode automatically exits if there is no button activity for five minutes.

SECTION 13: APPENDIX 1 – GLOSSARY

This Glossary explains the technical terms and parameters used in this manual. The entry type is also shown:

<i>General Definition:</i>	Terms normally applicable all models.
<i>Controller Definition:</i>	Terms applicable to Controller models only.
<i>VMD Controller Definition:</i>	Terms applicable to VMD Controller models only.
<i>Limit Controller Definition:</i>	Terms applicable to Limit Controller models only.
<i>Indicator Definition:</i>	Terms applicable to Indicator models only.
<i>General Parameter:</i>	Parameters normally applicable all models.
<i>Controller Parameter:</i>	Parameters applicable to Controller models only.
<i>VMD Controller Parameter:</i>	Parameters applicable to VMD Controller models only.
<i>Limit Controller Parameter:</i>	Parameters applicable to Limit Controller models only.
<i>Indicator Parameter:</i>	Parameters applicable to Indicator models only.
<i>Controller Tuning Parameter:</i>	Parameters relating to the tuning of Controller models.

Active Setpoint

Type: *Controller Definition* The

Active Setpoint is the setpoint used as the current target Setpoint Value. Some controllers can have more than one setpoint (e.g. Setpoint 1 and 2 or Local and Remote Setpoints), but only one of these is active at any time.

Also refer to Actual Setpoint, Remote Setpoint, Setpoint, Setpoint Select and Setpoint Select Enable.

Actual Setpoint

Type: *Controller Definition*

Actual Setpoint is the current value of the setpoint. This may be different to the Active Setpoint's target value if the setpoint is currently ramping. The actual setpoint will rise or fall at the ramp-rate set, until it reaches the target setpoint value.

Also refer to Active Setpoint, Setpoint, Setpoint Ramp Enable and Setpoint Select.

Alarm Hysteresis

Type: General Parameter

An adjustable band on the “safe” side of an alarm point, through which the process variable must pass before the alarm will change state, as shown in the diagram below. E.g. a high alarm’s hysteresis band is below the high alarm value, and a low alarm’s hysteresis is above the low alarm value.

Also refer to *Alarm Operation*.

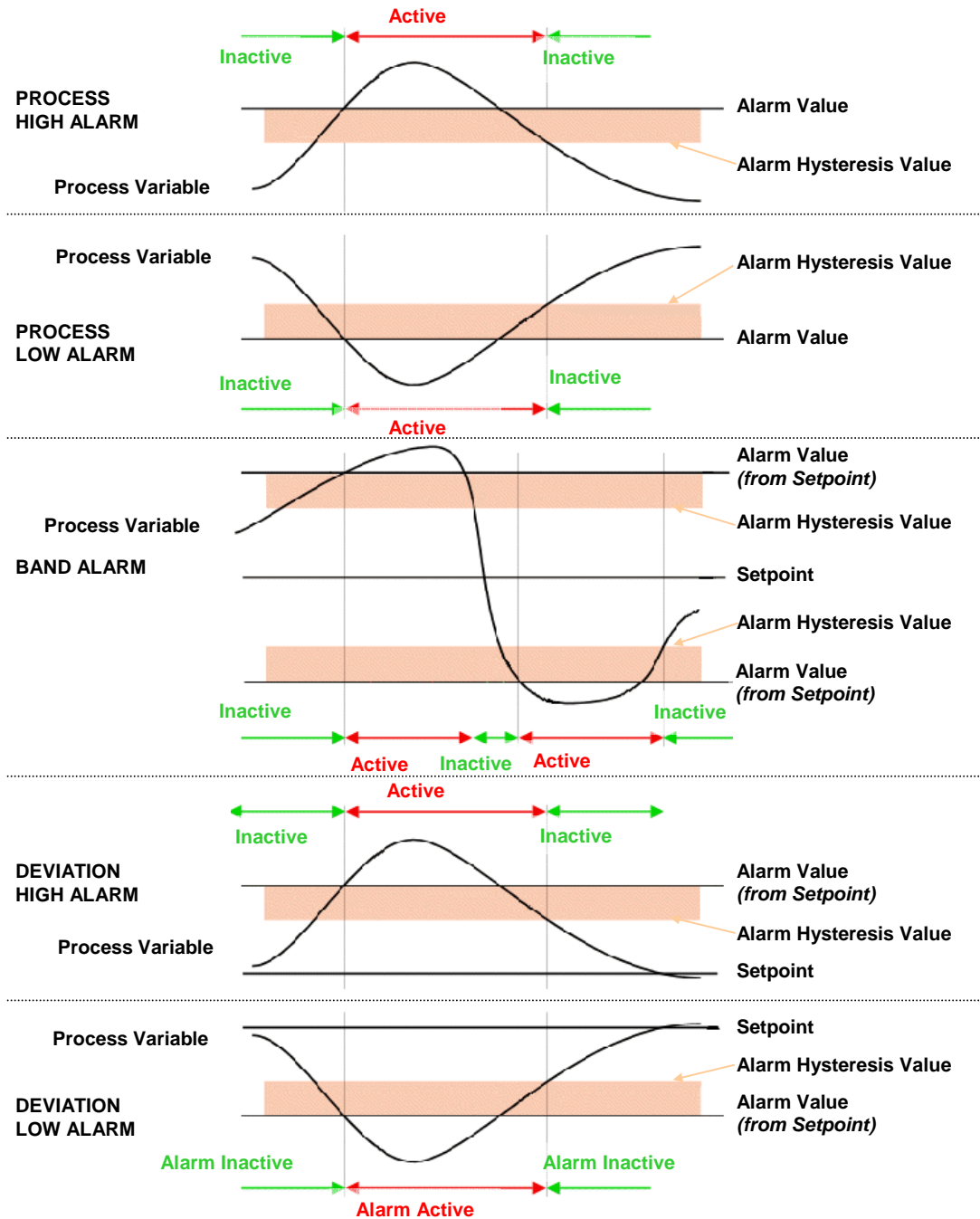

Figure 35. Alarm Hysteresis Operation

Alarm Operation

Type: General Definition

The different alarm types are shown below, together with the action of any outputs.
 Also refer to *Alarm Hysteresis*, *Alarm Inhibit*, *Band Alarm*, *Deviation Alarm*, *Latching Relay*, *Logical Alarm Combinations*, *Loop Alarm*, *Process High Alarm* and *Process Low Alarm*.

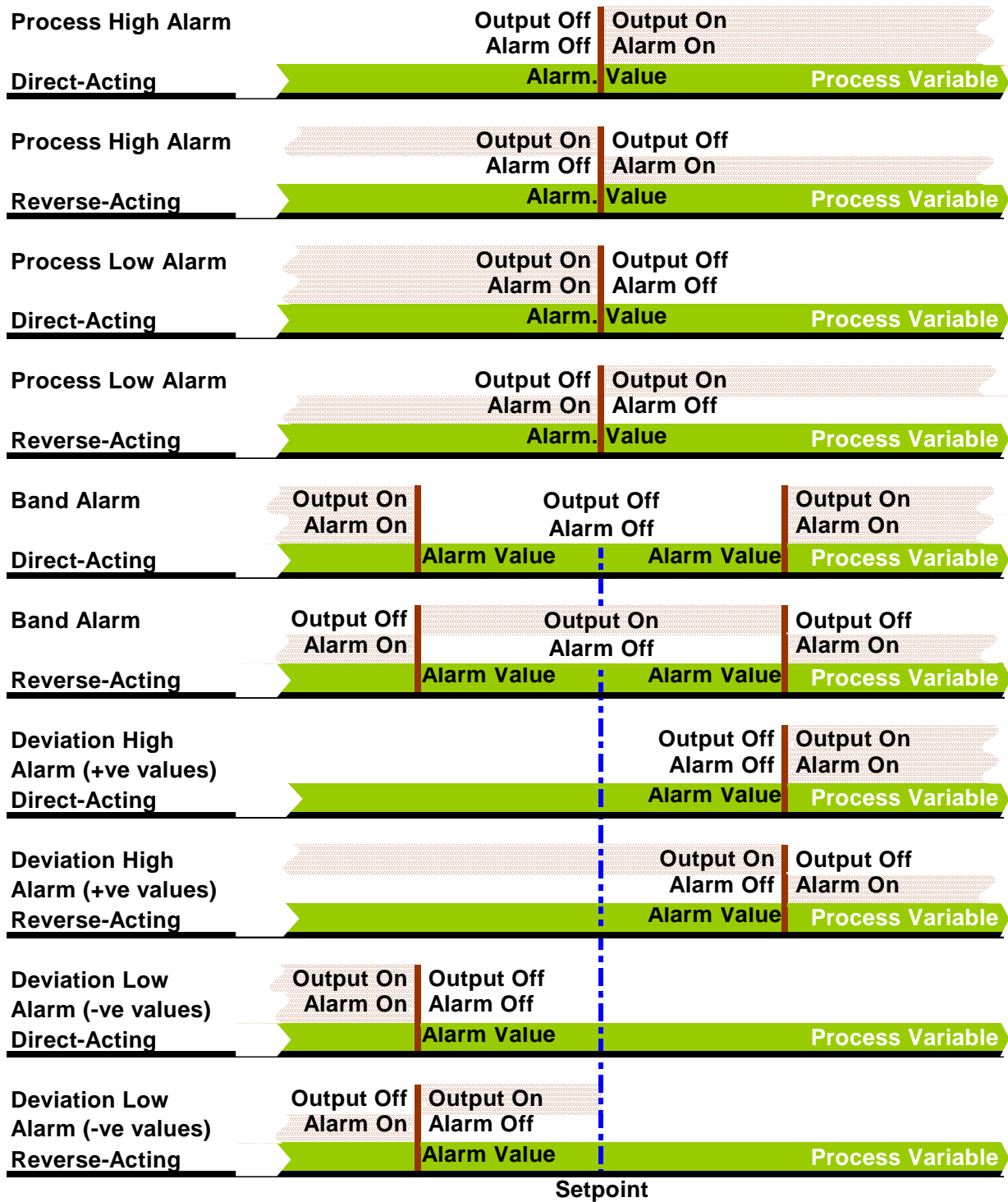

Figure 36. Alarm Operation

Alarm Inhibit

Type: General Parameter

Inhibits an alarm at power-up or when the controller Setpoint is switched, until that alarm goes inactive. The alarm operates normally from that point onwards.

Also refer to Alarm Operation.

Automatic Reset (Integral)

Type: Controller Tuning Parameter

Used to automatically bias the proportional output(s) to compensate for process load variations. It is adjustable in the range 1 seconds to 99 minutes 59 seconds per repeat and OFF (value greater than 99 minutes 59 seconds - display shows **OFF**). Decreasing the time increases the Integral action. This parameter is not available if the primary output is set to On-Off.

Display code = **ArSt**, default value = five minutes and zero seconds (**5.00**).

Also refer to Primary Proportional Band, Secondary Proportional Band, Rate, PID, and Tuning.

Auto Pre-Tune

Type: Controller Tuning Parameter

Determines whether the Auto Pre-Tune feature is activated on power up (**disA** = disabled, **enAb** = enabled). Auto Pre-Tune is useful when the process to be controlled varies significantly each time it is run. Auto Pre-Tune ensures that tuning occurs at the start of the process. Self-Tune may also be engaged to fine tune the controller.

Display code = **Apt**, default setting = **diSA**.

Also refer to Pre-Tune, Self-Tune and Tuning.

Auxiliary Input

Type: General Definition

A secondary linear input option module. It can be used as a Remote Setpoint input or for Valve Position Indication. Signals can be mA, mV, VDC or Potentiometer.

Also refer to Remote Setpoint, and Valve Position Indication.

Band Alarm 1 Value

Type: General Parameter

This parameter is applicable only if Alarm 1 is selected to be a Band Alarm. It defines a band of process variable values, centred on the current actual setpoint value. If the process variable value is outside this band, the alarm will be active. This parameter may be adjusted from 1 to full span from the setpoint.

Display code = **bAL1**, default value = 5.

Also refer to Alarm Operation, Band Alarm 2 Value and Input Span.

Band Alarm 2 Value

Type: General Parameter

This parameter, is similar to the Band Alarm 1 Value. It is applicable only if Alarm 2 is selected to be a Band Alarm.

Display code = **bAL2**, default value = 5.

Also refer to Alarm Operation, Band Alarm 1 Value and Input Span.

Bias (Manual Reset)

Type: Controller Tuning Parameter

Used to manually bias the proportional output(s) to compensate for process load variations. Bias is expressed as a percentage of output power and is adjustable in the range 0% to 100% (for Primary Output alone) or -100% to +100% (for both Primary and Secondary Outputs). This parameter is not applicable if the Primary output is set to ON/OFF control mode. If the process settles below setpoint use a higher Bias value to remove the error, if the process variable settles above the setpoint use a lower Bias value. Lower Bias values will also help to reduce overshoot at process start up.

Display code = **biAS**, default value = 25%.

Also refer to *ON/OFF Control and PID*.

Bumpless Transfer

Type: Controller Definition

A method used prevent sudden changes to the output power level when switching between Automatic and Manual control modes. During a transition from Automatic to Manual, the initial Manual Power value will be set to equal the previous automatic mode value. The operator can then adjust the value as required. During a transition from Manual to Automatic, the initial Automatic Power value will be set to equal the previous manual mode value. The correct power level will gradually applied by the control algorithm at a rate dependant on the integral action resulting from the Automatic Reset time. Since integral action is essential to Bumpless Transfer, this feature is not available if Automatic Reset is turned off.

Also refer to *Automatic Rest and Manual Mode*

Cascade Control

Type: Controller Definition

Applications with two or more capacities (such as heated jackets) are inherently difficult for a single instrument to control, due to large overshoots and unacceptable lags. The solution is to cascade two or more controllers, each with its own input, in series forming a single regulating device. The product setpoint temperature is set on the master controller. This is compared to the product temperature, and the master's PID output (mA or VDC) is fed into a remote setpoint input on the slave. The RSP is scaled to suit any expected temperature. The slave loop's natural response time should ideally be at least 5 times faster than the master.

In the example, the maximum input represents 400°C, thus restricting the jacket temperature. At start-up the master compares the product temperature (ambient) to its setpoint (300°C) and gives maximum output. This sets the maximum (400°C) setpoint on the slave, which is compared to the jacket temperature (ambient) giving maximum heater output.

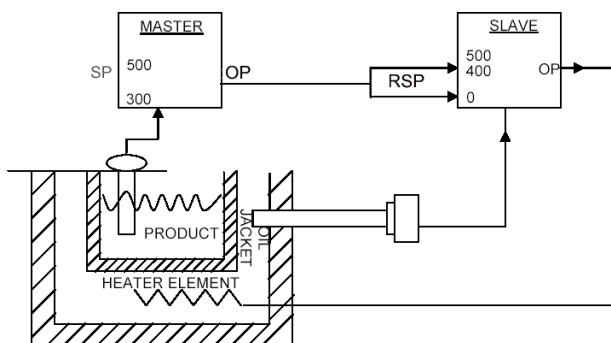

As the jacket temperature rises, the slave's heater output falls. The product temperature also rises at a rate dependant on the transfer lag between the jacket and product. This causes the master's PID output to decrease, reducing the 'jacket' setpoint on the slave, effectively reducing the output to the heater. This continues until the system becomes balanced.

When tuning a cascade system, first set the master to manual mode. Tune the slave controller using proportional control only (I & D

are not normally required) then return the master to automatic mode before tuning the master. The result is quicker, smoother control with minimum overshoot and the ability to cope with load changes, while keeping the jacket temperature within acceptable tolerances.

Also refer to *Manual Mode, Master & Slave, PID, Remote Setpoint, Remote Setpoint Lower Limit, Remote Setpoint Upper Limit, Setpoint, Setpoint Select and Tuning*.

Communications Write Enable

Type: General Definition

Enables/disables the changing of parameter values via the RS485 communications link, if the communications option is installed. Possible settings are read only or read/write. Display code = **CoEn**, default setting = **r_W** (read/write).

Control Type

Type: Controller Parameter

Defines if a controller has one or two control outputs. Single outputs can drive the PV in one direction only (e.g. heat only, cool only, increase humidity etc). Dual outputs can force the PV to increase or decrease (e.g. heat & cool, humidify and dehumidify etc).

Dual control is not possible on Valve Motor Drive controllers

Display codes = **SnGL** and **duAL**, default value = **SnGL**.

Also refer to PID, Primary Proportional Band, Process Variable, Secondary Proportional Band and Valve Motor Control.

Controller

Type: Controller Definition

An instrument that can control a Process Variable, using either PID or On-Off control methods.

Alarm outputs are also available that will activate at preset PV values, as are other options such as PV retransmission and Serial Communications.

Also refer to Alarm Operation, Indicator, Limit Controller, On-Off Control, PID, Process Variable, Retransmit Output and Serial Communications.

CPU

Type: General Definition

This stands for Central Processing Unit and refers to the onboard microprocessor that controls all of the measuring, alarm and control functions of the instrument.

Current Proportioning Control

Type: Controller Definition

Current proportioning control can be implemented on units configured with linear current or voltage output(s). It provides a 4 to 20mA, 0-20mA, 0 to 5V, 0 to 10V or 2 - 10V DC PID output. On-Off control should not be used with Current proportioning control.

Also refer to On-Off Control, PID, Primary Proportional Band, Rate, Secondary Proportional Band and Time Proportional Control.

Cycle Time

Type: Controller Definition

For time proportioning outputs, it is used to define time period over which the average on vs. off time is equal to the required PID output level. **Ct1**, **Ct2** and **Ct3** are available when option slots 1, 2 or 3 are defined as time proportioning output types. The permitted range of value is 0.5, 1, 2, 4, 8, 16, 32, 64, 128, 256 or 512 seconds. Shorter cycle times will give better control, but at the expense of reduce life when used with an electromechanical control device (e.g. relays or solenoid valves).

Display codes = **Ct1**, **Ct2** and **Ct3**, default value = 32.

Also refer to PID and Time Proportioning.

Deadband

Type: Controller Parameter

- Refer to *Overlap/Deadband*.

Derivative

Type: Controller Parameter

Refer to *Rate*.

Deviation Alarm 1 Value Type

Type: General Parameter

This is applicable only if Alarm 1 is selected to be Deviation Alarm. A positive value (Deviation High) sets the alarm point above the current actual setpoint, a negative value (Deviation Low) sets it

below. If the process variable deviates from the setpoint by a margin greater than this value, alarm 1 becomes active.

Display code = **dAL1**, Default value = 5.

Also refer to Alarm Operation and Deviation Alarm 2 Value.

Deviation Alarm 2 Value

Type: General Parameter

Applicable only if Alarm 2 is selected as a Deviation Alarm. It is similar to Deviation Alarm 1 Value.

Display code = **dAL2**. Default value = 5.

Also refer to Alarm Operation and Deviation Alarm 1 Value.

Differential (On-Off Hysteresis)

Type: Controller Parameter

A switching differential used when one or both control outputs have been set to On-Off. This parameter is adjustable within the range 0.1% to 10.0% of input span; the default value is 0.5%. The differential band is centred about the setpoint.

Relay chatter can be eliminated by proper adjustment of this parameter. Too large a value for this parameter will increase amplitude of oscillation in this process variable.

Display code = **diFp** for primary only differential, **diFS** for secondary only differential & **diFF** for primary and secondary differential.

Also refer to Input Span and On-Off Control.

Direct/Reverse Action of Control Outputs

Type: Controller Definition

Direct action is typically used with cooling applications; On-Off direct outputs will turn on when the process variable exceeds setpoint. Proportional direct outputs will increase the percentage of output as the process value increases within the proportional band. Reverse action is typically used with heating applications; On-Off reverse outputs will turn off when the process variable exceeds setpoint. Proportional reverse outputs will decrease the percentage of output as the process value increases within the proportional band. The Secondary Output will be direct whenever the Primary Output is selected as reverse. The Secondary Output will be reverse whenever the Primary Output is selected as direct.

Also refer to Control Type, On-Off Control, PID, Primary Proportional Band and Secondary Proportional Band

Display Strategy

Type: General Parameter

Alters the parameters displayed in normal operator mode. For example a controller could display PV + SP, PV + adjustable SP, PV + Ramping SP, PV only or SP only. Display strategy 6 will allow read only access to the setpoint values in Operator Mode, Setup Mode must then be entered to change the setpoint.

Display code = **diSp**

Also refer to Process Variable, Setpoint and Setpoint Ramping.

Input Filter Time Constant

Type: General Parameter

This parameter is used to filter out extraneous impulses on the process variable. The filtered PV is used for all PV-dependent functions (display control, alarm etc). The time constant is adjustable from 0.0 seconds (off) to 100.0 seconds in 0.5 second increments.

Display code = **FiLt**, Default value = 2.0 seconds.

Also refer to Process Variable.

Input Range

Type: General Definition

This is the overall process variable input range and type as selected by the **InPt** parameter in Configuration Mode.

Also refer to Input Span.

Input Span

Type: General Definition

The measuring limits, as defined by the Scale Range Lower and Scale Range Upper Limits. The trimmed span value is also used as the basis for calculations that relate to the span of the instrument (E.g. controller proportional bands)

Also refer to Input Range, Scale Range Lower Limit and Scale Range Upper Limit.

Integral

Type: Controller Tuning Parameter

Refer to *Automatic Reset*.

Latching Relay

Type: General Definition

A type of relay that, once it becomes active, requires a reset signal before it will deactivate. This output is available on Limit controllers and indicator alarms. To successfully deactivate a latched relay, the alarm or limit condition that caused the relay to become active must first be removed, then a reset signal can be applied. This signal may be applied from the instrument keypad, Digital Input or command via Serial Communication.

Also refer to Alarm Operation, Indicator, Limit Controller, Limit Hysteresis, Serial Communications.

LED

Type: General Definition

Light Emitting Diode. LED's are used as indicator lights (e.g. for the alarm indication). The upper and lower 7-segment displays are also LED's.

Lock Codes

Type: General Parameter

Defines the four-digit codes required to enter Configuration (20), Set-Up (10), and Auto Tuning (0) modes.

Display codes = **cLoc**, **SLoc** and **tLoc**, default values shown above in brackets.

Logical Combination of Alarms

Type: General Definition

Two alarms may be combined logically to create an AND/OR situation. Any suitable output may be assigned as a Logical Alarm Output, configured for Reverse-acting or Direct action.

Also refer to Alarm Operation

Table 27. Logical Alarm Outputs

Logical OR: Alarm 1 OR Alarm 2											
Direct Acting						Reverse-Acting					
ALARM 1	OFF	ALARM 2	OFF	OUTPUT	OFF	ALARM 1	OFF	ALARM 2	OFF	OUTPUT	ON
	ON		OFF		ON		ON		OFF		OFF
	OFF		ON		ON		ON		ON		OFF
	ON		ON		ON		ON		ON		OFF

Logical AND: Alarm 1 AND Alarm 2											
Direct Acting						Reverse-Acting					
ALARM 1	OFF	ALARM 2	OFF	OUTPUT	OFF	ALARM 1	OFF	ALARM 2	OFF	OUTPUT	ON
	ON		OFF		OFF		ON		OFF		ON
	OFF		ON		OFF		ON		ON		ON
	ON		ON		ON		ON		ON		OFF

Loop Alarm Enable

Type: Controller Parameter

Enables or disables a loop alarm. A loop alarm is a special alarm, which detects faults in the control feedback loop, by continuously monitoring process variable response to the control output(s). The loop alarm can be tied to any suitable output. When enabled, the loop alarm repeatedly checks if the control output(s) are at the maximum or minimum limit. If an output is at the limit, an internal timer is started: thereafter, if the high output has not caused the process variable to be corrected by a predetermined amount 'V' after time 'T' has elapsed, the loop alarm becomes active. Subsequently, the loop alarm mode repeatedly checks the process variable and the control output(s). When the process variable starts to change value in the correct sense or when the output is no longer at the limit, the loop alarm is deactivated.

For PID control, the loop alarm time 'T' is always twice the Automatic Reset parameter value. For On-Off control, a user defined value for the Loop Alarm Time parameter is used.

The value of 'V' is dependent upon the input type. For Temperature inputs, V = 2°C or 3°F. For Linear inputs, V = 10 least significant display units

Control output limits are 0% for Single output (Primary only) controllers and -100% for Dual output (Primary and Secondary) controllers.

Correct operation of the loop alarm depends upon reasonably accurate PID tuning. The loop alarm is automatically disabled during manual control mode and during execution of the Pre-Tune mode. Upon exit from manual mode or after completion of the Pre-Tune routine, the loop alarm is automatically re-enabled.

Display code = **LAEn**, default value = **diSA**,

Also refer to Loop Alarm Time, Manual Mode, On-Off Control, Pre-Tune, and Process Variable.

Loop Alarm Time

Type: Controller Parameter

When On-Off control is selected and loop alarm is enabled, this parameter determines the duration of the limit condition after which the loop alarm will be activated. It may be adjusted within the range of 1 second to 99 minutes 59 seconds. This parameter is omitted from the Set-up mode display sequence if On-Off control is not selected or loop alarm is disabled.

Display code = **LAti**, Default setting is 99:59.

Also refer to Loop Alarm Enable.

mADC

Type: General Definition

This stands for milliamp DC. It is used in reference to the DC milliamp input ranges and the linear DC milliamp outputs. Typically, these will be 0 to 20mA or 4 to 20mA.

Manual Mode

Type: Controller Definition

If Manual Mode is enabled in Set-Up mode, pressing the **AM** key in operator mode will cause a controller to enter or leave manual control mode. Switching between automatic and manual modes is achieved using bumpless transfer.

For standard Process Controllers Manual Mode operates as follows:

The upper display shows the current process value, and the lower display shows the output power in the form - **Pxxx** (where xxx is equal to the percentage output power). This value may be adjusted using the **UP** or **DOWN** keys to increase/decrease the power output. The value can be varied between 0% to 100% for controllers using primary control only, and -100% to +100% for controllers using primary and secondary control (e.g. full heat power to full cool power).

Manual Mode should be used with care because the power output level is set by the operator, therefore the PID algorithm is no longer in control of the process. The operator **MUST** maintain the process as the desired level manually. Manual power is not limited by the Primary Power Output Limit.

Also refer to Bumpless Transfer, Manual Mode Enable, PID, and Primary Output Power Limit.

Manual Mode Enable

Type: Controller Parameter

Determines whether operator selection and de-selection of manual control is enabled. If the mode is enabled in Set-Up mode, pressing the **AM** key in Operator Mode will normally activate or deactivate manual control mode. However, disabling **poen** while manual control mode is active will lock the controller into Manual Mode and pressing the Auto/Man key will no longer cause a return to PID (automatic) control. To exit from Manual Mode, **poen** must temporarily be re-enabled to allow PID control to be re-established. **poen** can then be safely disabled.

It is possible to use a controller as a permanent "Manual Station" by disabling **poen** to deliberately lock it into Manual Mode.

Manual Mode can also be selected using a digital input if one has been fitted and configured for this function. When in Manual Mode, the **MAN** LED indicator flashes.

Display code = **PoEn**, default setting = **diSA**.

Also refer to Manual Mode and PID

Master & Slave

Type: Controller Definition

The terms master & slave are used to describe the controllers in applications where one instrument controls the setpoint of another. The master controller can transmit the setpoint to the slave using an analogue DC linear signal. The slave controller must have a matching a remote setpoint input. Some Profile Controllers can transmit their setpoint via serial communications serial communications. For this method, the Profiler must be able to act as a communications master device and the slave must have a compatible communications option fitted.

Also refer to Cascade Control, Retransmit Output, Remote Setpoint, Serial Communications, Setpoint

Modulating Valve

Type: VMD Controller Definition

A valve that can be positioned anywhere between fully closed and fully open by means of an incorporated motor. A typical application would be controlling temperature in a furnace heated by gas burners. Some modulating valve motors require linear (mA or VDC) signals to position the valve. These require standard Process Controllers (using PI control).

Offset

Type: Controller Parameter

Offset is used to modify the measured process variable value and is adjustable in the range \pm input span. Use this parameter to compensate for errors in the displayed process variable. Positive values are added to the process variable reading, negative values are subtracted. This parameter is in effect, a calibration adjustment; it MUST be used with care. Injudicious use could lead to the displayed value bearing no meaningful relationship to the actual process variable. There is no front panel indication of when this parameter is in use.

Display value = **OFFS**, default value = 0.

Also refer to Input Span, Process Variable and Tare.

On-Off Control

Type: Controller Definition

When operating in On-Off control, the output(s) will turn on or off as the process variable crosses the setpoint in a manner similar to a central heating thermostat. Some oscillation of the process variable is inevitable when using On-Off control.

On-Off control can be implemented only with Time Proportioning Control (Relay, Triac or SSR driver output), by setting the corresponding proportional band(s) to zero. On-Off operation can be assigned to the Primary output alone (secondary output not present), Primary and Secondary outputs or Secondary output only (with the primary Output set for time proportional or current proportional control).

On-Off control cannot be used on Valve Motor Drive controllers.

Also refer to Differential, PID, Process Variable, Primary Proportional Band, Secondary Proportional Band, Setpoint, Time Proportioning Control and Valve Motor Drive Control.

On-Off Differential (Hysteresis)

Type: Controller Parameter

Refer to *Differential*.

Open Loop VMD

Type: VMD Controller Definition

An "Open Loop" PID control algorithm does not require a position feedback signal from the valve in order to correctly control the process. Instead, the Process Variable's deviation from the Setpoint is used to decide how long the valve open or close outputs should be energised (in relation to the Motor Travel Time) in order to bring the process under control.

Even when position feedback is provided for Valve Position Indication, the controller does not use this signal when positioning the valve, so problems associated with faulty feedback signals are avoided.

Also refer to Modulating Valve, Motor Travel Time, PID, Process Variable, Setpoint, Valve Position Indication and Valve Motor Drive Control.

Overlap/Deadband

Type: Controller Parameter

Defines the portion of the primary and secondary proportional bands ($Pb_P + Pb_S$) over which both outputs are active (Overlap), or neither is active (Deadband). It is adjustable in the range -20% to +20% of the two proportional bands added together. Positive values = Overlap, negative values = Deadband.

This parameter is not applicable if the primary output is set for On-Off control or there is no Secondary Output. If the Secondary Output is set for On-Off, this parameter has the effect of moving the Differential band of the Secondary Output to create the overlap or deadband. When Overlap/Deadband = 0, the "OFF" edge of the Secondary Output Differential band coincides with the point at which the Primary Output = 0%.

Display code = $\text{O}\Delta$, default value = 0%.

Also refer to *Differential, On-Off Control, Primary Proportional Band* and *Secondary Proportional Band*.

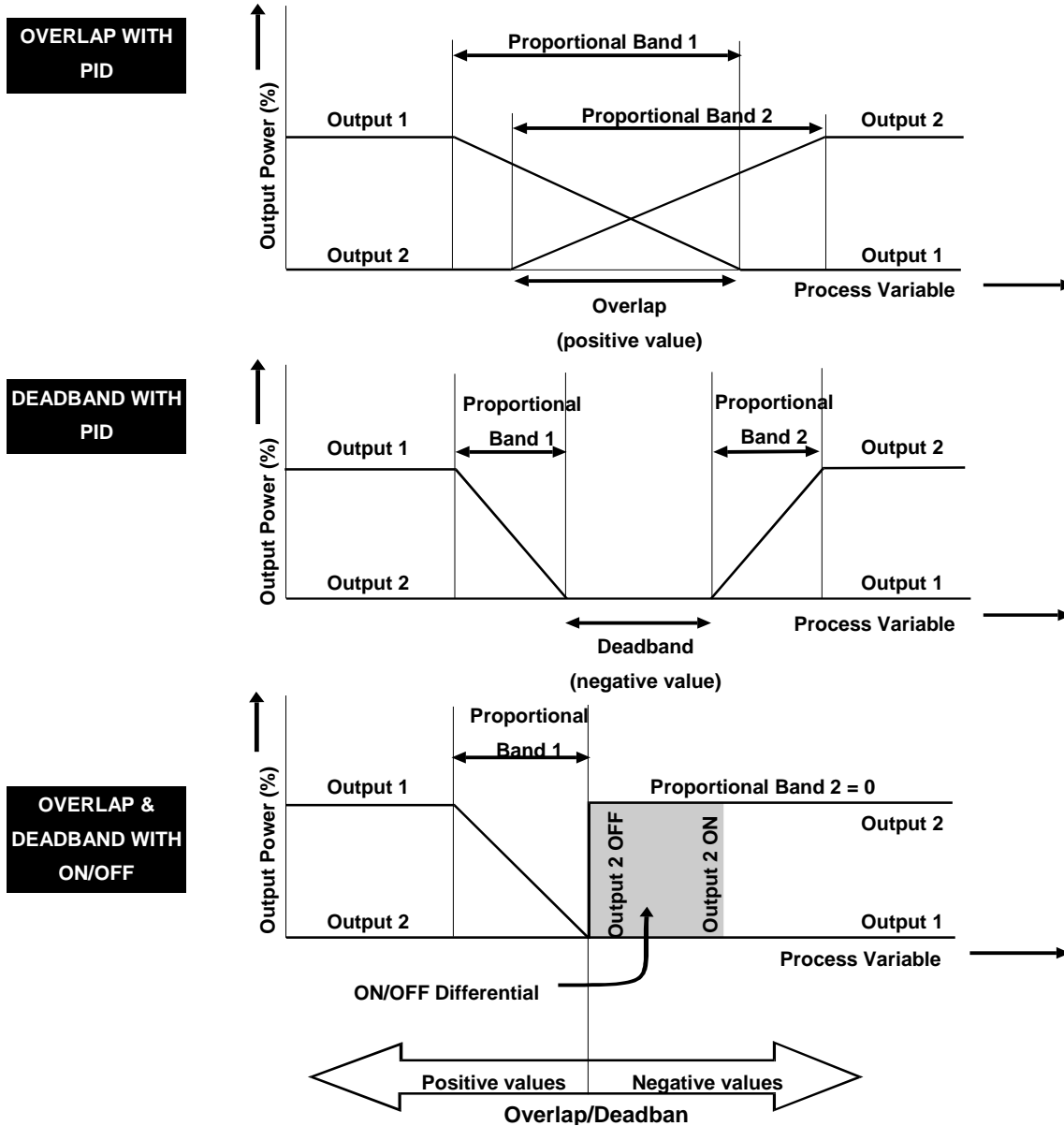

Figure 37. Overlap/Deadband

PI Control*Type: Controller Definition*

Proportional and Integral (PI) Control is used to control Modulating Valves. It is similar to PID Control, but without Derivative (Rate) action that causes excessive valve movement.

Also refer to *Modulating Valve, PID Control, Rate, Tuning and Valve Motor Drive Control*.

PID Control*Type: Controller Definition*

Proportional Integral and Derivative control maintains accurate and stable levels in a process (e.g. temperature control). It avoids the oscillation characteristic of On-Off control by continuously adjusting the output to keep the process variable stable at the desired setpoint.

Also refer to *Control Action, Control Type, Automatic Reset, Controller, Manual Mode, On-Off Control, PI Control, Primary Proportional Band, Process Variable, Rate, Secondary Proportional Band, Setpoint, Tuning and Valve Motor Drive Control*.

PLC*Type: General Definition*

This stands for Programmable Logic Controller. A microprocessor based device used in machine control. It is particularly suited to sequential control applications, and uses "Ladder Logic" programming techniques. Some PLC's are capable of basic PID control, but tend to be expensive and often give inferior levels of control.

Also refer to *PID*.

Pre-Tune

Type: Controller Definition

The Pre-Tune facility artificially disturbs the start-up pattern so that a first approximation of the PID values can be made prior to the setpoint being reached. During Pre-Tune, the controller outputs full Primary Power until the process value has moved approximately halfway to the setpoint. At that point, power is removed (or outputs full Secondary Power for Dual Control), thereby introducing an oscillation. Once the oscillation peak has passed, the Pre-Tune algorithm calculates an approximation of the optimum PID tuning terms proportional band(s), automatic reset and rate. The process is shown in the diagram below.

When Pre-Tune is completed, the PID control output power is applied using the calculated values. Pre-Tune limits the possibility of setpoint overshoot when the controller is new or the application has been changed. As a single-shot operation, it will automatically disengage once complete, but can be configured to run at every power up using the Auto Pre-Tune function.

The Pre-Tune feature on Valve Motor Drive controllers always sets the Rate parameter to zero (OFF) because derivative action is not usually desirable in these applications.

Pre-Tune will not engage if either primary or secondary outputs on a controller are set for On-Off control, during setpoint ramping or if the process variable is less than 5% of the input span from the setpoint. Pre-Tune Operation

Figure 38. Pre-Tune Operation

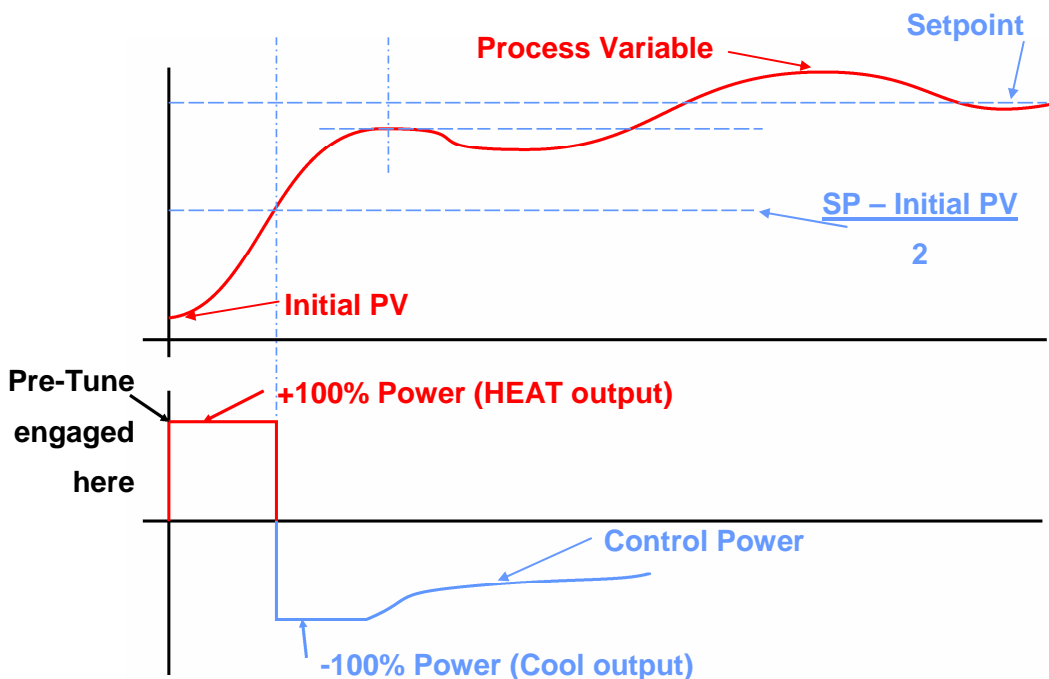

Also refer to *Auto Pre-Tune, Automatic Reset, Control Type, On-Off Control, Input Span, PID, Primary Proportional Band, Process Variable, Rate, Secondary Proportional Band, Self-Tune, Setpoint, Setpoint Ramping, Tuning and Valve Motor Drive Control.*

Primary Output Power Limit

Type: Controller Parameter

Used to limit the power level of the Primary Output and may be used to protect the process being controlled. It may be adjusted between 0% and 100%. This parameter is not applicable if the primary output is set for On-Off control.

Display code is **OPhi**, default value = 100%

Also refer to *On-Off Control.*

Primary Proportional Band

Type: Controller Tuning Parameter

The portion of the input span over which the Primary Output power level is proportional to the process variable value. It may be adjusted in the range 0.0% (ON/OFF) to 999.9%.

Applicable if Control Type is Single or Dual. For dual control a Secondary Proportional band is used for the second output. The Control Action can be Direct or Reverse acting.

The Display value = **Pb_P**, default value = 5.0%.

Also refer to Control Action, Control Type, On-Off Control, Input Span, Overlap/Deadband, PID, Secondary Proportional Band, and Tuning.

Process High Alarm 1 Value

Type: General Parameter

This parameter, applicable only when Alarm 1 is selected to be a Process High alarm, defines the process variable value above which Alarm 1 will be active. Its value may be adjusted between Scale Range Upper Limit and Scale Range Lower Limit.

Display code = **PHA1**, Default value = Scale Range Upper Limit.

Also refer to Alarm Operation, Process High Alarm 2 Value, Process Variable, Scale Range Lower Limit and Scale Range Upper Limit.

Process High Alarm 2 Value

Type: General Parameter

This parameter, applicable only when Alarm 2 is selected to be a Process High alarm. It is similar to the Process High Alarm 1 Value.

Display code = **PHA2**, Default value = Scale Range Upper Limit.

Also refer to Alarm Operation, Process High Alarm 1 Value, Process Variable, Scale Range Lower Limit and Scale Range Upper Limit.

Process Low Alarm 1 Value

Type: General Parameter

This parameter, applicable only when Alarm 1 is selected to be a Process low alarm, defines the process variable value below which Alarm 1 will be active. Its value may be adjusted between Scale Range Upper Limit and Scale Range Lower Limit.

Display code = **PLA1**, Default value = Scale Range Lower Limit.

Also refer to Alarm Operation, Process Low Alarm 2 Value, Process Variable, Scale Range Lower Limit and Scale Range Upper Limit.

Process Low Alarm 2 Value

Type: General Parameter

This parameter, applicable only when Alarm 2 is selected to be a Process low alarm. It is similar to the Process Low Alarm 1 Value.

Display code = **PLA2**, default value = Scale Range Lower Limit.

Also refer to Alarm Operation, Process Low Alarm 1 Value, Process Variable, Scale Range Lower Limit and Scale Range Upper Limit.

Process Variable (PV)

Type: General Definition

Process Variable is the variable to be measured by the primary input of the instrument. The PV can be any parameter that can be converted into a electronic signal suitable for the input. Common types are Thermocouple or PT100 temperature probes, or pressure, level, flow etc from transducers which convert these parameters into linear DC signals (e.g. 4 to 20mA). Linear signals can be scaled into engineering units using the Scale Range Lower Limit and Scale Range Upper Limit parameters.

Also refer to Input Span, Offset, Scale Range Lower Limit and Scale Range Upper Limit.

Process Variable Offset

Type: General Parameter

- Refer to *Offset*.

Rate (Derivative)

Type: Controller Tuning Parameter

Rate is adjustable in the range 0 seconds (OFF) to 99 minutes 59 seconds. It defines how the control action responds to the rate of change in the process variable. This parameter should not be used in modulating value applications as it can cause premature wear due to constant small adjustments to the valve position. The Rate parameter is not available if primary control output is set to On-Off.

The Rate parameter is normally set to 0 seconds (OFF) on Valve Motor Drive controllers because derivative action is not usually desirable in these applications.

Display code = **rAtE**, default value = 1.15.

Also refer to On-Off Control, PID, Process Variable, Tuning and Valve Motor Drive Control.

Remote Setpoint (RSP)

Type: Controller Definition

Remote Setpoints use the Auxiliary Input option (a secondary analogue input) to adjust a controller's setpoint using an external linear DC Voltage or mA input signal, or in some cases potentiometer or mV inputs. The Remote Setpoint value is constrained by the Setpoint Upper Limit and Setpoint Lower Limit settings in the same way as a local setpoint. Typical applications are Master/Slave and Cascade Control.

Display code = **RSP**.

Also refer to Auxiliary Input, Cascade Control, Remote Input Range, Remote Setpoint Lower Limit, Remote Setpoint Upper Limit, Setpoint and Setpoint Select.

Remote Auxiliary Input Range

Type: Controller Parameter

Defines the type and range of the linear input signal (mADC, mVDC, VDC or potentiometer) for the Auxiliary Input. mVDC and potentiometer are only available with the Full Auxiliary input module. This input can be used for Remote Setpoint or Valve Position Indication

Display code = **RinP**, default value = **0_10** for RSP inputs and **Pot** for Valve Position Indication.

Also refer to Remote Setpoint, Setpoint and Valve Position Indication

Remote Setpoint Lower Limit

Type: Controller Parameter

Defines the value of the Remote Setpoint when the RSP input signal is at its minimum value (eg for a 4 to 20mA RSP, the value when 4mA is applied). It may be adjusted within the range -1999 to 9999; (decimal position same as for process variable input). However, the RSP value is always constrained within the Setpoint Upper Limit and Setpoint Lower Limits.

Display code = **rSPL**, default value = PV input range minimum.

Also refer to Remote Setpoint, Remote Setpoint Input, Remote Setpoint Upper Limit, Remote Setpoint Offset, Setpoint and Setpoint Upper Limit and Setpoint Lower Limit.

Remote Setpoint Upper Limit

Type: Controller Parameter

Defines the value of the Remote Setpoint when the RSP input signal is at its maximum value (eg for a 4 to 20mA RSP, the value when 20mA is applied). It may be adjusted within the range -1999 to 9999; (decimal position same as for process variable input). However, the RSP value is always constrained within the Setpoint Upper Limit and Setpoint Lower Limits.

Display code = **rSPu**, default value = PV input range maximum.

Also refer to Remote Setpoint, Remote Setpoint Input, Remote Setpoint Lower Limit, Remote Setpoint Offset, Setpoint and Setpoint Upper Limit and Setpoint Lower Limit.

Remote Setpoint Offset

Type: Controller Parameter

Used to adjust the Remote Setpoint input value. Positive values are added to the RSP reading, negative values are subtracted. It is adjustable in the range -1999 to 9999, but is constrained within the Scale Range Upper Limit and Scale Range Lower Limit.

Display value = **rSPo**, default value = 0.

Also refer to Remote Setpoint, Scale Range Upper Limit and Scale Range Lower Limit.

Retransmit Output

Type: General Definition

A linear DC voltage or mA output signal, proportional to the Process Variable or Setpoint, for use by slave controllers or external devices, such as a Data Recorder or PLC. The output can be scaled to transmit any portion of the input or setpoint span.

Also refer to Input Span, Master & Slave, Process Variable and Setpoint.

Retransmit Output 1 Scale Maximum

Type: General Parameter

Scales a linear output module in slot 1 that has been set up to retransmit PV or SP. Retransmit Scale Maximum defines the value of the process variable, or setpoint, at which the output will be at its maximum value. E.g. for a 0 to 5V output, the value corresponds to 5V. It may be adjusted within the range -1999 to 9999; the decimal position is always the same as that for the process variable input. If this parameter is set to a value less than that for Retransmit Output 1 Scale Minimum, the relationship between the process variable/setpoint value and the retransmission output is reversed. Display code = **ro1H**, default value = Scale Range Upper Limit.

Also refer to Process Variable, Retransmit Output, Retransmit Output 1 Scale Minimum, Scale Range Upper Limit and Setpoint.

Retransmit Output 1 Scale Minimum

Type: General Parameter

Scales a linear output module in slot 1 that has been set up to retransmit PV or SP. Retransmit Scale Minimum defines the value of the process variable, or setpoint, at which the output will be at its minimum value. E.g. for a 0 to 5V output, the value corresponds to 0V. It may be adjusted within the range -1999 to 9999; the decimal position is always the same as that for the process variable input. If this parameter is set to a value greater than that for Retransmit Output Scale Maximum, the relationship between the process variable/setpoint value and the retransmission output is reversed. Display code = **ro1L**, default value = Scale Range Lower Limit.

Also refer to Process Variable, Retransmit Output, Retransmit Output 1 Scale Maximum, Scale Range Lower Limit and Setpoint.

Retransmit Output 2 Scale Maximum

Type: General Parameter

Defines the value of the process variable, or setpoint, at which Retransmit Output 2 will be at its maximum value. It is similar to Retransmit Output 1 Scale Maximum.

Display code = **ro2H**, default value = Scale Range Upper Limit.

Also refer to Process Variable, Retransmit Output, Retransmit Output 2 Scale Minimum, Scale Range Upper Limit and Setpoint.

Retransmit Output 2 Scale Minimum

Type: General Parameter

Defines the value of the process variable, or setpoint, at which Retransmit Output 2 will be at its minimum value. It is similar to Retransmit Output 1 Scale Minimum.

Display code = **ro2L**, default value = Scale Range Lower Limit.

Also refer to Process Variable, Retransmit Output, Retransmit Output 2 Scale Maximum, Scale Range Lower Limit and Setpoint.

Retransmit Output 3 Scale Maximum

Type: General Parameter

Defines the value of the process variable, or setpoint, at which Retransmit Output 3 will be at its maximum value. It is similar to Retransmit Output 1 Scale Maximum.

Display code = **ro3H**, default value = Scale Range Upper Limit.

Also refer to Process Variable, Retransmit Output, Retransmit Output 3 Scale Minimum, Scale Range Upper Limit and Setpoint.

Retransmit Output 3 Scale Minimum

Type: General Parameter

Defines the value of the process variable, or setpoint, at which Retransmit Output 3 will be at its minimum value. It is similar to Retransmit Output 1 Scale Minimum.

Display code = **ro3L**, default value = Scale Range Lower Limit.

Also refer to Process Variable, Retransmit Output, Retransmit Output 3 Scale Maximum, Scale Range Lower Limit and Setpoint.

Reset

Type: Controller Tuning Parameter

- Refer to *Automatic Reset*.

Scale Range Upper Limit

Type: General Parameter

For linear inputs, this parameter is used to scale the process variable into engineering units. It defines the displayed value when the process variable input is at its maximum value. It is adjustable from -1999 to 9999 and can be set to a value less than (but not within 100 units of) the Scale Range Lower Limit, in which case the sense of the input is reversed.

For thermocouple and RTD inputs, this parameter is used to reduce the effective range of the input. All span related functions work from the trimmed input span. The parameter can be adjusted within the limits of the range selected by Configuration Mode parameter **inpt**. It is adjustable to within 100 degrees of the Scale Range Lower Limit.

Display code = **rUL**, default value = 1000 for linear inputs or range maximum for temperature inputs.

Also refer to Input Span, Process Variable and Scale Range Lower Limit.

Scale Range Lower Limit

Type: General Parameter

For linear inputs, this parameter can be used to display the process variable in engineering units. It defines the displayed value when the process variable input is at its minimum value. It is adjustable from -1999 to 9999 and can be set to a value more than (but not within 100 units of) the Scale Range Upper Limit, in which case the sense of the input is reversed.

For thermocouple and RTD inputs, this parameter is used to reduce the effective range of the input. All span related functions, work from the trimmed span. The parameter can be adjusted within the limits of the range selected by Configuration Mode parameter **inpt**. It is adjustable to within 100 degrees of the Scale Range Upper Limit.

Display code = **rUL**, default value = 0 for linear inputs, or range minimum for temperature inputs.

Also refer to Input Span, Process Variable and Scale Range Upper Limit.

Secondary Proportional Band

Type: Controller Tuning Parameter

The portion of the input span over which the Secondary Output power level is proportional to the process variable value. It may be adjusted in the range 0.0% (ON/OFF) to 999.9%. The Control action for the Secondary Output is always the opposite of the Primary output.

The Secondary Proportional Band is only applicable when Dual Control Type is used.

Display value = **Pb_S**, default value = 5.0%.

Also refer to Control Action, Control Type, On-Off Control, Input Span, Overlap/Deadband, PID, Primary Proportional Band and Tuning.

Self-Tune

Type: Controller Tuning Definition

Self-Tune continuously optimises tuning while a controller is operating. It uses a pattern recognition algorithm, which monitors the process error (deviation). The diagram shows a typical application involving a process start up, setpoint change and load disturbance.

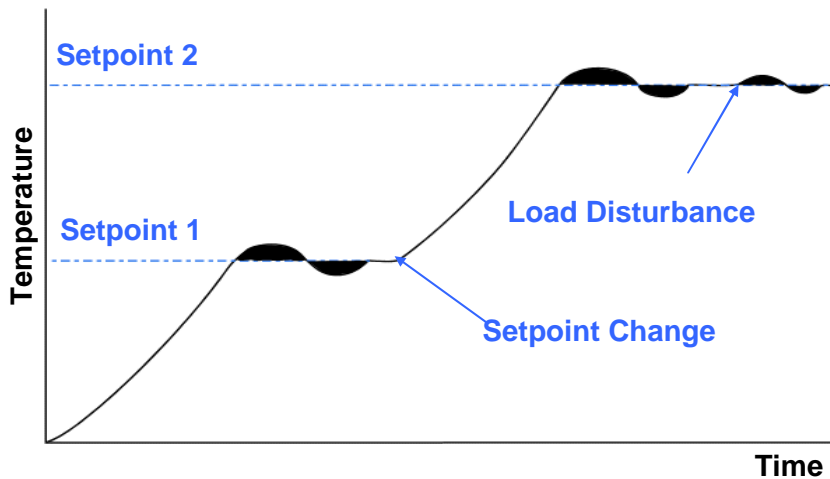

Figure 39. Self-Tune Operation

The deviation signal is shown shaded and overshoots have been exaggerated for clarity. The Self-Tune algorithm observes one complete deviation oscillation before calculating a set of PID values. Successive deviation oscillation causes values to be recalculated so that the controller rapidly converges on optimal control. When the controller is switched off, the final PID terms remain stored in the controller's non-volatile memory, and are used as starting values at the next switch on. The stored values may not always be valid, if for instance the controller is brand new or the application has been changed. In these cases the user can utilise Pre-Tune to establish new initial values.

Use of continuous self-tuning is not always appropriate for applications which are frequently subjected to artificial load disturbances, for example where an oven door is likely to be frequently left open for extended periods of time.

The Self-Tune feature on Valve Motor Drive controllers always sets the Rate parameter to zero (OFF) because derivative action is not usually desirable in these applications.

Self-Tune cannot be engaged if a controller is set for On-Off Control.

Also refer to *Minimum Motor On Time, On-Off Control, Pre-Tune, PID, and Tuning.*

Serial Communications Option

Type: General Definition

An feature that allows other devices such as PC's, PLC's or a master controller to read or change an instruments parameters via an RS485 Serial link. Full details can be found in the Serial Communications sections of this manual.

Also refer to *Controller, Indicator, Master & Slave, Limit Controller and PLC*

Set Valve Closed Position

Type: VMD Controller Parameter

When Valve Position Indication is to be used on Valve Motor Controllers, this parameter defines the input value that will be measured by the Auxiliary Input, when the valve is fully closed. The valve must driven to its "Closed" end stop before setting this parameter.

It must not be used to limit valve movement, separate Valve Close and Open Limit parameters are available for this purpose.

Display code = **PcUL**, default setting = Auxiliary Input Range Minimum.

Also refer to *Auxiliary Input, Set Valve Opened Position, Valve Close Limit, Valve Open Limit, Valve Motor Control and Valve Position Indication.*

Set Valve Opened Position

Type: VMD Controller Parameter

When Valve Position Indication is to be used on Valve Motor Controllers, this parameter defines the input value that will be measured by the Auxiliary Input, when the valve is fully opened. The valve must be driven to its "Open" end stop before setting this parameter.

It must not be used to limit valve movement, separate Valve Close and Open Limit parameters are available for this purpose.

Display code = **PcLL**, default setting = Auxiliary Input Range Maximum.

Also refer to Auxiliary Input, Set Valve Closed Position, Valve Close Limit, Valve Open Limit, Valve Motor Control and Valve Position Indication.

Setpoint

Type: Controller Definition

The target value at which a controller will attempt to maintain the process variable by adjusting its power output level. Controllers can have either one or two setpoints. These can be one or two local internal setpoints (**SP** or **SP1** and **SP2**), or one local internal setpoint (**LSP**) and one externally adjusted remote (**RSP**) setpoint, if a Remote Setpoint module is fitted. The value of the setpoints can be adjusted between the Setpoint Upper Limit and Setpoint Lower Limits. The active setpoint is defined by the status of the Setpoint Select parameter or a digital input.

Also refer to Limit Setpoint, Process Variable, Remote Setpoint, Scale Range Lower Limit, Setpoint Lower Limit, Setpoint Upper Limit and Setpoint Select

Setpoint Upper Limit

Type: Controller Parameter

The maximum limit allowed for operator setpoint adjustments. It should be set to keep the setpoint below a value that might cause damage to the process. The adjustment range is between Scale Range Upper Limit and Scale Range Lower Limit. The value cannot be moved below the current value of the setpoint.

Display code = **SPuL**, default value is Scale Range Upper Limit.

Also refer to Scale Range Lower Limit, Scale Range Upper Limit, Setpoint and Setpoint Lower Limit.

Setpoint Lower Limit

Type: Controller Parameter

The minimum limit allowed for operator setpoint adjustments. It should be set to keep the setpoint above a value that might cause damage to the process. The adjustment range is between Scale Range Lower Limit and Scale Range Upper Limit. The value cannot be moved above the current value of the setpoint.

Display code = **SPLL**, default value = Scale Range Lower Limit.

Also refer to Scale Range Lower Limit, Scale Range Upper Limit, Setpoint and Setpoint Upper Limit.

Setpoint Ramping Enable

Type: Controller Parameter

Enables or disables the viewing and adjustment of the Setpoint Ramp Rate in Operator Mode. This parameter does not disable the ramping SP feature; it merely removes it from Operator Mode. It can still be viewed and adjusted in Setup Mode. To turn off ramping, the ramp rate must be set to OFF (*blank*).

Display code = **SPr**, default setting = Disabled.

Also refer to Process Variable, Setpoint and Setpoint Ramp Rate.

Setpoint Ramp Rate

Type: Controller Parameter

The rate at which the actual setpoint value will move towards its target value, when the setpoint value is adjusted or the active setpoint is changed. With ramping in use, the initial value of the actual

setpoint at power up, or when switching back to automatic mode from manual control, will be equal to the current process variable value. The actual setpoint will rise/fall at the ramp rate set, until it reaches the target setpoint value. Setpoint ramping is used to protect the process from sudden changes in the setpoint, which would result in a rapid rise in the process variable. Display code = **rP**, default setting = OFF (*blank*).

Also refer to Manual Mode, Setpoint, Setpoint Ramp Enable and Setpoint Select.

Setpoint Select

Type: Controller Parameter

This Operator Mode parameter is available if the remote setpoint feature is in use and setpoint select is enabled, Setpoint Select defines whether the local or the remote setpoint will be the Active Setpoint. It can be set to **diGi**, **LSP**, or **rSP**. If a digital input has been configured for local/remote setpoint selection, the default setting is **diGi**. This means the status of the digital input will determine which setpoint is active. Otherwise the user can only choose **LSP**, or **rSP**. The active setpoint is indicated by prefixing its legend with the “_” character. E.g. the local setpoint legend is **__LSP**, when it is active and **LSP** when it is inactive.

If a digital input has been configured to select local/remote SP, setting Setpoint Select to **LSP**, or **rSP** will override the digital input and the active SP indication changes to *.

Display code = **SPS**.

Also refer to Active Setpoint, Remote Setpoint, Setpoint and Setpoint Select Enable.

Setpoint Select Enable

Type: Controller Parameter

If the remote setpoint feature is in use, this determines whether operator selection of setpoints is enabled or disabled. If enabled, the Setpoint Select parameter is available in operator mode. If Setpoint Select is disabled again, the active setpoint will remain at its current status.

Display code = **SSEn**, default setting = **diSA** (disabled).

Also refer to Remote Setpoint and Setpoint.

Solid State Relay (SSR)

Type: General Definition

An external device manufactured using two Silicone Controlled Rectifiers, which can be used to replace mechanical relays in most AC power applications. As a solid state device, an SSR does not suffer from contact degradation when switching electrical current. Much faster switching cycle times are also possible, leading to superior control. The instrument's SSR Driver output is a time proportioned 10VDC pulse, which causes conduction of current to the load when the pulse is on.

Also refer to Cycle Time, Time Proportioning Control, and Triac.

Solenoid Valve

Type: General Definition

An electromechanical device to control gas or liquid flow. It has just two states, open or closed. A spring holds the valve closed until a current is passed through the solenoid coil forces it open. Standard Process Controllers with Time Proportioned outputs are used to control solenoid valves. Solenoid valves are often used with high/low flame gas burners. A bypass supplies some gas at all times, but not enough to heat the process more than a nominal amount (low flame). A controller output opens the solenoid valve when the process requires additional heat (high flame)..

Also refer to Modulating Valves and Time Proportioning Control.

Tare

Type: Indicator Parameter

When an Indicator's Tare function has been enabled, the operator can set the current Process Variable input value to be displayed as zero. This function may be used to easily eliminate any offset on the input signal, e.g. when a transducer output is not giving a true zero value. It may also be used in applications displaying the weight of a product, to remove the weight of a container before starting. When Tare is activated, the instrument automatically sets the PV Offset to an equal, but opposite value to the current measured value.

Display code = **tArE**, default setting = **diSA** (disabled).
Also refer to Indicator, Process Variable, and Offset.

Three Point Stepping Control

Type: VMD Controller Definition

Refer to *Valve Motor Control*.

Time Proportioning Control

Type: Controller Definition

Time proportioning control is accomplished by cycling the output on and off, during the prescribed cycle time, whenever the process variable is within the proportional band. The control algorithm determines the ratio of time (on vs. off) to achieve the level of output power required to correct any error between the process value and setpoint. E.g. for a 32 second cycle time, 25% power would result in the output turning on for 8 seconds, then off to 24 seconds. This type of output might be used with electrical contactors, Solid State Relays Time proportioning control can be implemented with Relay, Triac or SSR Driver outputs for either primary (Heat) or secondary (Cool) outputs depending on hardware configuration.

Also refer to Current Proportioning Control, Cycle Time, PID, Primary Proportional Band, Process Variable, Secondary Proportional Band, Setpoint, SSR and Triac.

Tuning

Type: Controller Definition

PID Controllers must be tuned to the process in order for them to attain the optimum level of control. Adjustment is made to the tuning terms either manually, or by utilising the controller's automatic tuning facilities. Tuning is not required if the controller is configured for On-Off Control.

Also refer to Automatic Reset, Auto Pre-Tune, On-Off control, PID, Pre-Tune, Primary Proportional Band, Rate, Self-Tune and Secondary Proportional Band.

Triac

Type: General Definition

A small internal solid state device, which can be used in place of a mechanical relay in applications switching low power AC, up to 1 amp. Like a relay, the output is time proportioned, but much faster switching cycle times are also possible, leading to superior control. As a solid-state device, a Triac does not suffer from contact degradation when switching electrical currents. A triac cannot be used to switch DC power.

Also refer to Cycle Time, SSR and Time Proportioning Control.

Valve Close Limit

Type: VMD Controller Parameter

When Valve Position Indication is to be used on Valve Motor Controllers, this parameter provides a "clamp" on the upper valve position, which the controller will not attempt to drive the valve past. It can be set between 0 (fully closed) and the Valve Open Limit value -1, expressed as a percentage of the valve's "fully open" position.

The Auxiliary Input must correctly scaled using the Set Valve Open and Closed parameters before using this parameter.

Display code = **PIUL**, default setting = **0**.

Also refer to Auxiliary Input, Set Valve Closed Position, Set Valve Open Position, Valve Open Limit, Valve Motor Control and Valve Position Indication.

Valve Motor Drive Control

Type: VMD Controller Definition

Valve Motor Drive Controllers are designed to control Modulating Valves using a special “Open Loop” Valve Motor Drive (VMD) PI control algorithm. Output signals are provided to move the valve further open, or further closed when the process is higher or lower than the desired setpoint. When on setpoint, no output is required to maintain control unless load conditions change. This known as Three-Point Stepping control.

Valve Position or Flow Indication is possible if an Auxiliary Input option module has been fitted and configured for this purpose.

Also refer to Auxiliary Input, Modulating Valve, Open Loop VMD, PI Control, PID, Setpoint and Valve Position Indication.

Valve Position or Flow Indication

Type: VMD Controller Definition

The Valve Motor Drive Controllers do not require any kind of position feedback in order for the PID algorithm to correctly control the process. However, where feedback or flow level signals are available, they can be displayed as a percentage (0 to 100) of the possible valve opening or flow level. Valve Position Indication is shown in the Operator Mode lower display in place of the Setpoint when the Display Strategy is set to 7.

Valve Position Feedback is usually provided by means of a potentiometer linked to the valve.

Potentiometers can be directly connected to the Full Auxiliary Input (Option Slot B only).

Flow meters typically have linear 0-20/4-20mA or 0-5/0-10V signals, which can be used with either the Full Auxiliary Input or the Basic Auxiliary Input (Option Slot A only) of the $\frac{1}{16}$ Din VMD Controllers.

Even when position feedback is provided in this way, the information is not used by the Open Loop VMD control algorithm when positioning the valve, avoiding problems associated with faulty feedback signals.

Also refer to Auxiliary Input, Display Strategy, Open Loop VMD, PID, Set Valve Closed Position, Set Valve Open Position, Setpoint, and Valve Motor Control.

Valve Open Limit

Type: VMD Controller Parameter

When Valve Position Indication is to be used on Valve Motor Controllers, this parameter provides a “clamp” on the upper valve position, which the controller will not attempt to drive the valve past. It can be set between 100 (fully open) and the Valve Closed Limit value +1, expressed as a percentage of the valve’s “fully open” position.

The Auxiliary Input must correctly scaled using the Set Valve Open and Closed parameters before using this parameter.

Display code = **PiLL**, default setting = 100.

Also refer to Auxiliary Input, Set Valve Closed Position, Set Valve Open Position, Valve Close Limit, Valve Motor Control and Valve Position Indication.

VMD

Type: VMD Controller Parameter

- Refer to *Valve Motor Control*.

SECTION 14: APPENDIX 2 – SPECIFICATION

14.1 Universal Input

General Input Specifications

Input Sample Rate:	Four samples/second.	
Digital Input Filter time constant	0.0 (OFF), 0.5 to 100.0 seconds in 0.5 second increments.	
Input Resolution:	14 bits approximately. Always four times better than display resolution.	
Input Impedance:	10V DC:	47K Ω
	20mA DC:	5 Ω
	Other ranges:	Greater than 10M Ω resistive
Isolation:	Isolated from all outputs (except SSR driver). If single relay outputs are connected to a hazardous voltage source, and the universal input is connected to operator accessible circuits, supplementary insulation or input grounding is required.	
PV Offset:	Adjustable \pm input span.	
PV Display:	Displays process variable up to 5% over and 5% under span.	

Thermocouple

Thermocouple Ranges Available

Sensor Type	Range Min in $^{\circ}$ C	Range Max in $^{\circ}$ C	Range Min in $^{\circ}$ F	Range Max in $^{\circ}$ F	Resolution
J (default)	-200	1200	-328	2192	1 $^{\circ}$
J	-128.8	537.7	-199.9	999.9	0.1 $^{\circ}$
T	-240	400	-400	752	1 $^{\circ}$
T	-128.8	400.0	-199.9	752.0	0.1 $^{\circ}$
K	-240	1373	-400	2503	1 $^{\circ}$
K	-128.8	537.7	-199.9	999.9	0.1 $^{\circ}$
L	0	762	32	1403	1 $^{\circ}$
L	0.0	537.7	32.0	999.9	0.1 $^{\circ}$
N	0	1399	32	2551	1 $^{\circ}$
B	100	1824	211	3315	1 $^{\circ}$
R	0	1759	32	3198	1 $^{\circ}$
S	0	1762	32	3204	1 $^{\circ}$
C	0	2320	32	4208	1 $^{\circ}$
PtRh20%: PtRh40%	0	1850	32	3362	1 $^{\circ}$

Note:

Defaults to °F for USA units. Defaults to °C for non-USA units.

The Configuration Mode parameters, Scale Range Upper Limit and Scale Range Lower Limit, can be used to restrict range.

Thermocouple Performance

Calibration:	Complies with BS4937, NBS125 and IEC584.
Measurement Accuracy:	±0.1% of full range span ±1LSD. NOTE: Reduced performance for B Thermocouple from 100 to 600°C. NOTE: PtRh 20% vs PtRh 40% Thermocouple accuracy is 0.25% and has reduced performance below 800°C.
Linearisation Accuracy:	Better than ±0.2°C any point, for 0.1° resolution ranges (±0.05°C typical). Better than ±0.5°C any point, for 1° resolution ranges.
Cold Junction Compensation:	Better than ±0.7°C under reference conditions. Better than ±1°C under operating conditions.
Temperature Stability:	0.01% of span/°C change in ambient temperature.
Supply Voltage Influence:	Negligible.
Relative Humidity Influence:	Negligible.
Sensor Resistance Influence:	Thermocouple 100Ω: <0.1% of span error. Thermocouple 1000Ω: <0.5% of span error.
Sensor Break Protection:	Break detected within two seconds. Process Control outputs turn OFF (0% power); Valve Control "Close" outputs turn on; Limit outputs turn off (goes into Exceed condition); Alarms operate as if the process variable is over-range.

Resistance Temperature Detector (RTD)**RTD Ranges Available**

Range Min in °C	Range Max in °C	Range Min in °F	Range Max in °F	Resolution
-128.8	537.7	-199.9	999.9	0.1°
-199	800	-328	1472	1°(default)

Note:

Scale Range Upper Limit and Scale Range Lower Limit Configuration Mode parameters can be used to restrict range.

RTD Performance

Type:	Three-wire Pt100.
Calibration:	Complies with BS1904 and DIN43760 ($0.00385\Omega/\Omega/^\circ\text{C}$).
Measurement Accuracy:	$\pm 0.1\%$ of span $\pm 1\text{LSD}$.
Linearisation Accuracy:	Better than $\pm 0.2^\circ\text{C}$ any point, any 0.1°C range ($\pm 0.05^\circ\text{C}$ typical). Better than $\pm 0.5^\circ\text{C}$ any point, any 1°C range.
Temperature Stability:	0.01% of span/ $^\circ\text{C}$ change in ambient temperature.
Supply Voltage Influence:	Negligible.
Relative Humidity Influence:	Negligible.
Sensor Resistance Influence:	Pt100 50 Ω /lead: <0.5% of span error.
Lead Compensation:	Automatic scheme.
RTD Sensor Current:	150 μA (approximately).
Sensor Break Protection:	Break detected within two seconds. Process Control outputs turn OFF (0% power); Valve Control "Close" outputs turn on; Limit outputs turn off (goes into Exceed condition); Alarms operate as if the process variable has gone over-range.

DC Linear

DC Linear Ranges Available

0 to 20mA	0 to 50mV	0 to 5V
4 to 20mA (default)	10 to 50mV	1 to 5V
		0 to 10V
		2 to 10V

DC Linear Performance

Scale Range Upper Limit:	-1999 to 9999. Decimal point as required.
Scale Range Lower Limit:	-1999 to 9999. Decimal point as for Scale Range Upper Limit.
Minimum Span:	1 display LSD.
Measurement Accuracy:	$\pm 0.1\%$ of span $\pm 1\text{LSD}$.
Temperature stability:	0.01% of span/ $^\circ\text{C}$ change in ambient temperature.
Supply Voltage Influence:	Negligible.
Relative Humidity Influence:	Negligible.
Input Protection:	Up to 10 times maximum span of selected input connection.
Sensor Break Protection:	Applicable for 4 to 20mA, 1 to 5V and 2 to 10V ranges only. Process Control outputs turn OFF (0% power); Valve Control "Close" outputs turn on; Limit outputs turn off (goes into Exceed condition); Alarms operate as if process variable is under-range.

14.2 Auxiliary Inputs

Input Sampling rate:	4 per second
Input Resolution:	13 bits minimum
Input types:	4 to 20mA, 0 to 20mA, 0 to 10V, 2 to 10V, 0 to 5V, 1 to 5V. The Full Auxiliary input in Option Slot B also supports 0 to 100mv and Potentiometer (2K Ω or higher).
Measurement Accuracy (reference conditions):	$\pm 0.25\%$ of input span ± 1 LSD
Input resistance:	Voltage ranges: 47K Ω nominal Current ranges: 5 Ω
Input protection:	Voltage input: will withstand up to 5x input voltage overload without damage or degradation of performance in either polarity. Current input: will withstand 5x input current overload in reverse direction and up to 1A in the normal direction.
Isolation:	Slot A has basic isolation from other inputs and outputs. Slot B has reinforced isolation from other inputs and outputs.
Sensor Break Detection:	For 4 to 20mA, 2 to 10V and 1 to 5V ranges only.

14.3 Digital Inputs

Type:	Voltage-free or TTL-compatible
Voltage-Free Operation: <i>functions depend on model and how configured</i>	Connection to contacts of external switch or relay: Open = SP1, Automatic Mode or Local setpoint selected. <i>Minimum contact resistance = 5KΩ,</i> Closed = SP2, Manual Mode, Remote Setpoint selected, Latching Relay, Stored Min/Max/Time reset (edge triggered) or Tare activate (edge triggered). <i>Maximum contact resistance = 50Ω.</i>
TTL levels: <i>functions depend on model and how configured</i>	2.0 to 24VDC = SP1, Automatic Mode, Local Setpoint selected. -0.6 to 0.8VDC = SP2, Manual Mode, Remote Setpoint selected, Latching Relay, Stored Min/Max/Time reset (edge triggered) or Tare activate (edge triggered).
Maximum Input Delay (OFF-ON):	0.25 second.
Maximum Input Delay (ON-OFF):	0.25 second.
Isolation:	Reinforced safety isolation from any source of hazardous voltages.

14.4 Output Specifications

Output Module Types

Option Slot 1 Module Options:	Relay, SSR drive, Triac or DC linear. <i>Limit Controllers have a fixed Latching Relay only.</i>
Option Slot 2 Module Options:	Relay, Dual Relay, SSR drive, Triac or DC linear. <i>Dual Relay option on some models only.</i>
Option Slot 3 Module Options:	Relay, Dual Relay, SSR drive, DC Linear or Transmitter PSU. <i>Dual Relay option on some models only.</i>

Specifications of Output Types

Single Relay:	Contact Type:	Single pole double throw (SPDT).
	Control Rating:	2A resistive at 240V AC (120V when directly driving motorised valves). Limit Controller has a fixed 5A latching relay, in Option Slot 1.
	Alarm Rating:	2A resistive at 240V AC
	Control/Alarm Lifetime:	>500,000 operations at rated voltage/current.
	Limit Output Lifetime:	>100,000 operations at rated voltage/current.
	Isolation:	Basic Isolation from universal input and SSR outputs.
Dual Relay:	Contact Type:	2 x Single pole single throw (SPST) with shared common.
	Control Rating:	2A resistive at 240V AC (120V when directly driving motorised valves).
	Control/Alarm Lifetime:	>200,000 operations at rated voltage/current.
	Isolation:	Reinforced safety isolation from inputs and other outputs.
SSR Driver:	Drive Capability:	10V minimum at up to 20mA load.
	Isolation:	Not isolated from universal input or other SSR driver outputs.

Triac:	Operating Voltage Range:	20 to 280Vrms @47 to 63Hz. (140V max when directly driving motorised valves).
	Current Rating:	0.01 to 1A (full cycle rms on-state @ 25°C); derates linearly above 40°C to 0.5A @ 80°C.
	Max. Non-repetitive Surge Current (16.6ms):	25A peak.
	Min. OFF-State dv/dt @ Rated Voltage:	500V/ μ s.
	Max. OFF-State leakage @ Rated Voltage:	1mA rms.
	Max. ON-State Voltage Drop @ Rated Current:	1.5V peak.
	Repetitive Peak OFF-state Voltage, V _{drm} :	600V minimum.
	Isolation:	Reinforced safety isolation from inputs and other outputs.
Linear DC:	Resolution:	Eight bits in 250mS (10 bits in 1 second typical, >10 bits in >1 second typical).
	Update Rate:	Every control algorithm execution.
	Ranges:	0 to 10V 0 to 20mA 0 to 5V 4 to 20mA 2 to 10V (default)
	Load Impedance:	0 to 20mA & 4 to 20mA: 500 Ω maximum. 0 to 5V, 0 to 10V & 2 to 10V: 500 Ω minimum. Short circuit protected.
	Accuracy:	\pm 0.25% (mA @ 250 Ω , V @ 2k Ω). Degrades linearly to \pm 0.5% for increasing burden (to specification limits).
	When used as control output:	For 4 to 20mA and 2 to 10V a 2% over/underdrive is applied (3.68 to 20.32mA and 1.84 to 10.16V).
	Isolation:	Reinforced safety isolation from inputs and other outputs.
	Use as 0 to 10VDC transmitter power supply* <i>Indicators only.</i>	Adjustable, 0.0 to 10.0V (regulated) output into 500 Ω minimum.
Transmitter Power Supply: <i>*see Linear output spec for 0-10V PSU</i>	Power Rating	19 to 28VDC (24V nominal) into 910 Ω minimum resistance.
	Isolation:	Reinforced safety isolation from inputs and other outputs.

14.5 Control Specifications

Automatic Tuning Types:	Pre-Tune, Self-Tune.
Proportional Bands:	0 (ON/OFF control), 0.5% to 999.9% of input span at 0.1% increments. <i>ON/OFF control not valid for VMD controllers.</i>
Automatic Reset (Integral Time Constant):	1s to 99min 59s and OFF.
Rate (Derivative Time Constant):	0 (OFF) to 99 min 59 s.
Manual Reset (Bias):	Added each control algorithm execution. Adjustable in the range 0 to 100% of output power (single output) or -100% to +100% of output power (dual output). <i>Not valid for VMD controllers.</i>
Deadband/Overlap:	-20% to +20% of Proportional Band 1 + Proportional Band 2. <i>Not valid for VMD controllers</i>
ON/OFF Differential:	0.1% to 10.0% of input span.
Motor Travel Time	5 seconds to 5 minutes
Minimum Motor On Time	0.0 seconds to (Motor Travel Time/10)
Auto/Manual Control:	User-selectable with “bumpless” transfer into and out of Manual Control.
Cycle Times:	Selectable from 0.5s to 512 seconds in binary steps.
Setpoint Range:	Limited by Setpoint Upper Limit and Setpoint Lower Limit.
Setpoint Maximum:	Limited by Setpoint and Scale Range Upper Limit.
Setpoint Minimum:	Limited by Scale Range Lower Limit and Setpoint.
Setpoint Ramp:	Ramp rate selectable 1 to 9999 LSD's per hour and infinite. Number displayed is decimal-point-aligned with display.

14.6 Process Alarms

Maximum Number of Alarms (Controllers):	Two “soft” process alarms (high, low, deviation or band) plus Loop Alarm.
Maximum Number of Alarms (Indicators):	Five “soft” alarms (process high or low)
Combinatorial Alarms:	Logical OR or AND of alarms to any suitable output.

14.7 Digital Communications

Type:	Asynchronous Serial.
Protocols Supported:	Modbus RTU (all models) and ASCII (some models).
Physical Layer:	RS485.
Zone address range:	1 to 99 (ASCII), 1 to 255 (Modbus).
Bit rate:	1200, 2400, 4800, 9600 and 19200 bps.
Bits per character:	ASCII: 10 Modbus: 10 or 11 (depending on parity setting)
Stop bits:	1
Parity:	ASCII: Even (fixed). Modbus: None, even or odd (selectable).
Isolation:	Reinforced safety isolation from inputs and outputs.

14.8 Reference Conditions

Ambient Temperature:	20°C ±2°C.
Relative Humidity:	60 to 70%.
Supply Voltage:	100 to 240V AC 50Hz ±1%.
Source Resistance:	<10Ω for thermocouple input.
Lead Resistance:	<0.1Ω/lead balanced (Pt100).

14.9 Operating Conditions

Ambient Temperature (operating):	0°C to 55°C.
Ambient Temperature (storage):	-20°C to 80°C.
Relative Humidity:	20% to 95% non-condensing.
Altitude:	Up to 2000m above sea level.
Supply Voltage:	Either 100 to 240V ±10% AC 50/60Hz or 20 to 48V AC 50/60Hz & 22 to 55V DC
Power Consumption:	5W / 7.5 VA maximum.
Source Resistance:	1000Ω maximum (thermocouple).
PT100 Input Lead Resistance:	50Ω per lead maximum, balanced

14.10 Standards

Conformance Norms:	CE, UL, ULC.
EMC standards:	EN61326*
Safety Standards:	EN61010 and UL3121. Pollution Degree 2, Installation Category II. Also FM 3545, 1998 for Limit Controllers.
Front Panel Sealing:	IP66

Note:

**For disturbances induced by RF fields of 10V/m 80% AM at 1kHz the input accuracy specification is changed to 0.25% in the frequency bands 465 to 575 MHz and 630 to 660 MHz.*

14.11 Physical Specifications

Dimensions:	Depth behind panel:	110mm (¹ / ₁₆ DIN instruments). 100mm (¹ / ₈ & ¹ / ₄ DIN instruments).
	Front bezel size (w x h):	48 x 48mm (¹ / ₁₆ DIN instruments). 48 x 96mm (¹ / ₈ DIN controllers). 96 x 48mm (¹ / ₈ DIN indicators). 96 x 96mm (¹ / ₄ DIN instruments).
Mounting:	Plug-in with panel mounting fixing strap.	
Panel cut-out size (w x h)::	45mm x 45mm (¹ / ₁₆ DIN instruments). 45 x 92mm (¹ / ₈ DIN controllers). 92 x 45mm (¹ / ₈ DIN indicators). 92mm x 92mm (¹ / ₄ DIN instruments).	
Terminals:	Screw type (combination head).	
Weight:	0.21kg maximum.	

SECTION 15: APPENDIX 3 – PRODUCT CODING

Model Code	P1400 - X - X - X - X - X - X - X - X - X - X - X - X - Sxxx												
Option Slot 1													
Not fitted													0
Relay Output													1
DC Drive Output for SSR													2
Linear DC Output													3
Triac Output													8
Option Slot 2													
Not fitted													0
Relay Output													1
DC Drive Output for SSR													2
Linear DC Output													3
Triac Output													8
Option Slot 3													
Not fitted													0
Relay Output													1
DC Drive Output for SSR													2
Linear 0-10V DC Output													3
Transmitter PSU													4
Option Slot A** and Display Color													
Not fitted	Red Upper/Red Lower											0	0
RS-485 Serial Communications	Red Upper/Red Lower											1	1
Digital Input 1	Green Upper/Red											3	3
Auxiliary Input (<i>Basic</i>)													4
Supply Voltage													
100-240V AC													0
24-48V AC or DC													2
Display Colour													
Red Display (single display) or Red/Red (dual display)													0
Green Display (single display) or Green/Green (dual display)													1
Red Upper/Green Lower Display (dual display only)													2
Green Upper/Red Lower Display (dual display only)													3
Colour Change Single Display (Red/Green)													4
Option Slot B (¹/₈ & ¹/₄ DIN instruments only) ***													
Not fitted													0
Auxiliary Input (<i>Full</i>) with Digital Input 2													R

Manual Language												
No Manual												0
English												1

French												2
German												3
Italian												4
Spanish												5
Mandarin												6
English/French/German/Italian/Spanish - Concise Manuals only												9
** Slot A Basic Aux must not be installed if Slot B Full Aux is fitted.												
*** Slot B is only available on 1/4 DIN controllers.												

Model Code Pxxxx -x -x -x -x -x -x -x -x -x -x -x -Sxxx

Packing Options

Single Pack with Concise Manual												0
Bulk Pack with 1 Concise Manual per unit - (Minimum 20 pieces)												1
Bulk Pack No Manual - (Minimum 20 pieces)												2
Bulk Pack with 1 Full Manual per unit - (Minimum 20 pieces)												3
Single Pack with 1 Full Manual per unit												5

Special Variants

Standard Model (Special features not fitted)												Blank
Non-standard Model (Special features fitted)												Not Blank

Note:
Not all of the above code combinations are possible with every model.



Product Warranty

See separate warranty for Standard Products (Form BB7)

Parts, Materials and Labor

Seller warrants the equipment manufactured by Seller and not by others, to be free from defects in workmanship and material under normal use and service for a period of (1) year from the date of delivery or the period of two thousand (2,000) accumulated hours of use, whichever period is shorter. Use or service with corrosive or abrasive chemicals or materials is not deemed normal. The period of the forgoing warranty, in the case of furnaces, shall be ninety (90) days or five hundred twenty-five (525) accumulated hours of use, whichever period is shorter. Components manufactured by others including expendable items, are warranted only in accordance with the warranty, if any, issued by such other manufacturer.

Buyer shall give Seller written notice of any defects with 14 days after discovery thereof, specifying each particular defect discovered. If such notice is properly given, Seller will correct without charge any workmanship that is demonstrated to Seller's satisfaction to have been defective at the time of installation, and will repair or replace, at Seller's option, without charge, f.o.b. Seller's factory, parts covered by this warranty that upon inspection are found defective under normal use within the warranty period above stated. All work of removal and reinstallation, whether or not found defective, and shipping charges for defective or replacement parts shall be at the sole expense of Buyer.

The foregoing warranty shall not apply to (i) work done or materials furnished by others in connection with installation work performed without supervision by Seller's installation supervisors, or (ii) equipment repaired or altered by others unless such repairs or alterations were specifically agreed to in writing by an Officer of Seller. Seller shall not be liable for consequential damages of any kind which occur during the course of installation of equipment, or which result from the use or misuse by Buyer, its employees or others of the equipment supplied hereunder, and Buyer's sole and exclusive remedy against Seller for any breach of the foregoing warranty or otherwise shall be for the repair or replacement of the equipment of parts thereof affected by such breach.

The foregoing warranty shall be valid and binding upon Seller if and only if Buyer loads, operates and maintains the equipment supplied hereunder in accordance with the instruction manual to be provided upon delivery of the equipment. Seller does not guarantee the process of manufacture by Buyer or the quality of product to be produced by the equipment supplied hereunder, and Seller shall not be liable for prospective profits.

Despatch will repair or replace, at Despatch's option, FOB Despatch's factory, parts and materials covered by this warranty. Despatch is not responsible for parts or material failures resulting from misuse, abuse, inadequate preventative maintenance, acts of nature, or non-conforming utilities, including electrical, fuel supply, environmental and intake/exhaust provisions. This warranty also does not cover normal wear or routine maintenance parts and materials expressly designed as expendable/consumable and replaceable. (Note: Laboratory oven electric heaters are warranted for a period of five (5) years from date of shipment; three (3) years from date of shipment for Protocol Plus and DES 2000 temperature controllers).

Labor services for parts and materials replacement and repair to support this warranty are available at Despatch's normal service fees. This service is provided worldwide by a network of factory trained professionals.

Transportation Costs

All transportation costs to transport defective parts or materials to Despatch and to transport repaired or replacement parts or materials to Customer shall be the responsibility of the Customer.

Terms and Conditions

This Warranty shall be deemed valid and binding upon Despatch if and only if the Customer:

1. Installs, loads, operates and maintains the covered product supplied hereunder in accordance with the instruction manual provided upon delivery and product labeling affixed to the subject equipment;
2. If applicable, follows the Emergency Procedure set forth in this Warranty; and
3. Contacts Despatch's Helpline at 1-800-473-7373 for assistance in diagnosing and troubleshooting the problem immediately upon discovering any damage or malfunction. Despatch's reasonable determination as to whether a repair, replacement, or service is covered by this Warranty shall be final and binding.

Exclusions

This Warranty DOES NOT cover:

1. Damage or malfunctions, or expenses incurred in the process of diagnosing and/or repairing damage or malfunctions, resulting from any of the following: operator error, misuse, abuse, inadequate preventative maintenance, normal wear and tear, service or modifications by other than Despatch authorized technicians, use of the covered product that is inconsistent with the operation manual or labeling, acts of nature (including, without limitation, floods, fire, earthquake, or acts of war or civil emergency) internal or external corrosion, or non-conforming utilities (including, without limitation, electrical, fuel supply, environmental and intake/exhaust installations);
2. Repair or replacement of parts or materials designed and intended to be expendable or consumable; refrigerants, filters, lamps;
3. Routine maintenance; or
4. Labor costs incurred for troubleshooting, diagnostics or testing (except for testing required to verify that a covered defective part or material has been repaired).

Limitations of Liability

Despatch, shall not, in any event, be liable for indirect, special, consequential, incidental, or punitive damages or penalties of any kind, including, without limitation loss of revenue, profits or business opportunities resulting from interruption of process or production. In no event shall Despatch be liable for damages in excess of the amounts paid by Customer to Despatch with respect to the applicable product(s). This Warranty does not cover, and Despatch shall not be liable for any losses, costs, damages or expenses resulting from delays in diagnosing or repairing the products, supplying or obtaining replacement parts or materials, strikes, labor stoppages or shortages, fires, accidents, government acts or regulations, or any other causes beyond the control of Despatch.

Non-Compliance By Customer

Despatch reserves the right to suspend and withhold service under this Warranty in the event of non-compliance by the Customer to any terms and conditions of this Warranty or the applicable purchase order or invoice. Further, Despatch shall not be liable for any loss of production, expenses, and inconveniences incurred due to such suspension.

Customer Furnished Equipment Warranty Limitation

This Warranty does not cover diagnosis or repairs of defects in or caused by, lack of performance of, or fitness for purpose of customer-supplied parts or equipment unless specifically noted in the Despatch written order acceptance confirmation.

Performance Commitment

Despatch provides no guarantee of process performance or fitness for purpose, unless specifically noted otherwise in Despatch written order acceptance confirmation. Despatch is providing equipment with design parameters specific only to its equipment.

Procedure Upon Discovery of Defects and Emergencies

In the event Customer becomes aware of any defect in the applicable products, Customer must immediately: (a) shut off fuel or energy supply (gas and electricity), (b) call for emergency assistance, if needed, and (c) notify Despatch Service.

THE REPRESENTATION AND WARRANTIES SET FORTH HEREIN ARE EXCLUSIVE AND IN LIEU OF AND CUSTOMER HEREBY WAIVES AND DISCLAIMS RELIANCE UPON, ALL OTHER REPRESENTATIONS AND WARRANTIES OF EVERY KIND WHATSOEVER, WHETHER EXPRESS OR IMPLIED, OR ARISING BY OPERATION OF LAW OR IN EQUITY, OR BY COURSE OF PERFORMANCE OR DEALING OR USAGE OF TRADE, INCLUDING, WITHOUT LIMITATION, ANY IMPLIED WARRANTIES OF MERCHANTABILITY OR OF FITNESS FOR A PARTICULAR PURPOSE.

THIS WARRANTY IS PERSONAL TO THE CUSTOMER AND MAY NOT BE TRANSFERRED OR ASSIGNED. ALL LIMITATIONS HEREUNDER, HOWEVER, SHALL BE BINDING ON ALL SUCCESSORS AND ASSIGNS OF CUSTOMER.

Service

Worldwide Phone 952-469-8230; Worldwide Fax 952-469-8193; North American Phone 800-473-4373
e-mail service@despatch.com; www.despatch.com

Please see reverse side for other service offerings

Despatch Industries

Advantage Service Assurance Program (ASAP)

CONTACT: DESPATCH SERVICE AGREEMENTS SPECIALIST at 800-473-7373 or 952-469-8230
or e-mail: service@despatch.com

Despatch continues to deliver exceptional products backed by a strong sense of responsibility and drive for long term customer satisfaction. Your partnership with Despatch can offer even higher value through your subscription to one of Despatch's Advantage Service Assurance Program(ASAP).

Warranty

Despatch's exclusive, comprehensive service programs start with the 1 year parts only warranty which is described on the other side of this document. This warranty can be expanded immediately to meet your most stringent service needs. Despatch Service Products Group will be able to answer your service questions and provide a quotation for the immediate expansion of your product warranty. Call 800-473-7373 or 952-469-8230; or e-mail service@despatch.com.

Immediate Service Response

The key to an effective service program is response. Wherever your location, Despatch is only a phone call away. Our U.S. and Canadian customers can reach Despatch at 1-800-473-7373. Worldwide customers can call 1-952-469-8230 or FAX 1-952-469-8193. Our Customer Service Technicians have over 150 years combined experience and access to detailed design and manufacturing documentation specific to your Despatch unit(s). This exacting level of service is a benefit only Despatch can provide and means that you can expect speedy, accurate and the most cost effective response.

Field Service Network

A worldwide network of factory trained Service Professionals is available to support your Despatch equipment. From routine repair to certified instrument calibration, the Despatch service network is positioned to respond to your needs. As a manufacturer of custom equipment, our service programs are customized to meet your specific needs regarding:

1. Service scope
2. Response time
3. Preventive maintenance frequency and content
4. Payment method

Sustained Service Support

At Despatch, long term customer satisfaction means more than just responding quickly and effectively to our customers' service needs. It means offering comprehensive customer support well beyond the scope and duration of our initial warranty. Despatch offers two basic service packages which are customized to each individual customer's need. These service packages are titled Full Service and Preventive Maintenance Plus+ service agreement products. Each is unique in the industry and offer the following benefits:

1. Priority response for minimum production interruption
2. Preventive maintenance for longer product life
3. Discounts on parts and services
4. Various payment plans to ease budgeting and recording expenses
5. Reduce purchase ordering costs

Service

Worldwide Phone 952-469-8230; Worldwide Fax 952-469-8193; North American Phone 800-473-7373
e-mail service@despatch.com; www.despatch.com
